

COLLECTIONS BOOK 24

Indice alfabetico

Alphabetical index / Index alphabétique / Alphabetischer Index

A	Arbor	282
	Atlantis	54
	Badia	292
	Blendstone	68
	Canova	160
	Cementart	206
	Cottage	84
	Crossover	222
	Garda	232
	Hills	96
	Kompakt	244
	Lathemar	104
	Marvilla	180
	Materika	252
	Neutra Roc	112
	Palatina	196
	Pangea	116
	Pastelli	32
	Pietre Pure	130
	Stonequartz	142
	Stucchi	260
	Venexia	268
	Vibes	46
Z	Wooder	298

COLLECTIONS
BOOK
24

COLLECTIONS BOOK 24

Contenuti

Contents

Alfalux world	10
Le collezioni / The collections	28
Le Tinte	30
Le Pietre	52
I Marmi	158
I Cementi	204
I Legni	280
Info tecniche / Technical info	308

Indice per formato

Index by size / Index par taille / Index nach Format

160x320
63" x 126"

Canova **160**

120x278
47" x 109,45"

Canova **160**
Cementart **206**
Venexia **268**

120x120
47" x 47"

Atlantis **54**
Blendstone **68**
Canova **160**
Cementart **206**
Garda **232**
Marvilla **180**
Pangea **116**
Venexia **268**

90x270
36" x 106"

Canova **160**
Garda **232**
Marvilla **180**
Pastelli **32**

90x90
36" x 36"

Canova **160**
Cottage **84**
Crossover **222**
Garda **232**
Pastelli **32**
Stucchi **260**
Venexia **268**

45x90
18" x 36"

Canova **160**
Cottage **84**
Garda **232**
Pastelli **32**
Stonequartz **142**
Venexia **268**

30x90
12" x 36"

Canova **160**
Garda **232**
Pastelli **32**
Venexia **268**

60x120
24" x 47"

Atlantis **54**
Blendstone **68**
Canova **160**
Cementart **206**
Cottage **84**
Crossover **222**
Garda **232**
Hills **96**
Kompakt **244**
Marvilla **180**
Materika **252**
Palatina **196**
Pangea **116**
Pietre Pure **130**
Stonequartz **142**
Stucchi **260**
Venexia **268**

Composizione modulo
60x120 - 60x90 - 30x60
24" x 47" - 24" x 36" - 12" x 24"

Cottage **84**
Stonequartz **142**

40x120
16" x 47"

Arbor **282**
Badia **292**
Wooder **298**

30x120
12" x 47"

Badia **292**

20x120
8" x 47"

Arbor **282**
Badia **292**
Wooder **298**

9,6x49,9
3,78" x 19,64"

Wooder **298**

60x60
24" x 24"

Atlantis **54**
Blendstone **68**
Canova **160**
Cementart **206**
Cottage **84**
Crossover **222**
Garda **232**
Hills **96**
Kompakt **244**
Marvilla **180**
Materika **252**
Neutra Roc **112**
Palatina **196**
Pangea **116**
Pietre Pure **130**
Stonequartz **142**
Stucchi **260**
Venexia **268**

Composizione modulo vintage
60x60 - 40x40 - 20x40 - 20x20
24" x 24" - 16" x 16" - 8" x 16" - 8" x 8"

Stonequartz **142**

30x60
12" x 24"

Atlantis **54**
Blendstone **68**
Canova **160**
Cementart **206**
Cottage **84**
Crossover **222**
Garda **232**
Hills **96**
Kompakt **244**
Marvilla **180**
Materika **252**
Palatina **196**
Pangea **116**
Pietre Pure **130**
Stonequartz **142**
Stucchi **260**
Venexia **268**

30x30
12" x 12"

Lathemar **104**
Stonequartz **142**

15x30
6" x 12"

Lathemar **104**

15x15
6" x 6"

Atlantis **54**
Lathemar **104**
Stonequartz **142**

20x40
8" x 16"

Atlantis **54**
Blendstone **68**
Pietre Pure **130**
Stonequartz **142**

20x20
8" x 8"

Atlantis **54**
Blendstone **68**
Pietre Pure **130**
Stonequartz **142**
Venexia **268**

8x25
3,22" x 9,84"

Vibes **46**

Indice per superficie

Look index / Index par aspect / Verzeichnis nach optik

Spessore/ Thickness  6 / 8 / 9 / 10 / 12 / 20 MM

NON RETT /RETT	Arbor	9 MM	282
	Atlantis	8 / 9 MM	54
	Badia	9 MM	292
	Blendstone	8 / 9 MM	68
	Cementart	6 / 9 MM	206
	Cottage	9 MM	84
	Crossover	9 MM	222
	Garda	6 / 9 MM	232
	Hills	9 MM	96
	Kompakt	9 MM	244
	Lathemar	8 MM	104
	Materika	9 MM	252
	Palatina	9 MM	196
	Pangea	9 MM	116
	Pietre Pure	8 / 9 MM	130
	Stonequartz	8 / 9 MM	142
	Stucchi	9 MM	260
Venexia	6 / 9 MM	268	
Wooder	9 MM	298	

MATT NON RETT /MATT RETT	Canova	6 / 9 / 12 MM	160
	Garda	6 MM	232
	Marvilla	6 / 9 MM	180
	Pastelli	6 MM	32
	Vibes	9 MM	46

LAPPATO RETT	Pietre Pure	9 MM	130
---------------------	-------------	------	------------

SHINY NON RETT	Vibes	9 MM	46
-----------------------	-------	------	-----------

GRIP/GRIP RETT	Arbor	9 / 20 MM	282
	Atlantis	9 / 20 MM	54
	Blendstone	9 / 20 MM	68
	Cementart	9 / 20 MM	206
	Cottage	9 / 20 MM	84
	Garda	9 / 20 MM	232
	Pangea	9 / 20 MM	116
	Pietre Pure	9 MM	130
	Stonequartz	9 / 20 MM	142
	Venexia	9 / 20 MM	268
	Wooder	9 / 20 MM	298

LUCIDO NON RETT /LUCIDO RETT	Canova	6 / 9 / 12 MM	160
	Marvilla	6 / 9 MM	180
	Palatina	9 MM	196

ROC/ROC RETT	Atlantis	8 / 9 MM	54
	Badia	20 MM	292
	Blendstone	8 / 9 MM	68
	Canova	9 MM	160
	Cementart	9 MM	206
	Hills	9 MM	96
	Neutra Roc	20 mm	112
	Pangea	9 MM	116
	Pietre Pure	8 / 9 / 20 MM	130

TOUCH RETT	Marvilla	9 MM	180
-------------------	----------	------	------------

SILK RETT	Cottage	9 MM	84
------------------	---------	------	-----------

TECH RETT	Pastelli	6 MM	32
------------------	----------	------	-----------

Indice per effetto

Look index / Index par aspect / Verzeichnis nach optik

30

LE TINTE	Pastelli	32
Paint effect	Vibes	46
Imitation couleur		
Farboptik		

52

LE PIETRE	Atlantis	54
Stone effect	Blendstone	68
Imitation Pierre	Cottage	84
Steineffekt	Hills	96
	Lathemar	104
	Neutra ROC	112
	Pangea	116
	Pietre Pure	130
	Stonequartz	142

158

I MARMI	Canova	160
Marble effect	Marvilla	180
Imitation marbre	Palatina	196
Marmor-optik		

204

I CEMENTI	Cementart	206
Concrete effect	Crossover	222
Cotto Imitation Ciments	Garda	232
Beton-Optik	Kompakt	244
	Materika	252
	Stucchi	260
	Venexia	268

280

I LEGNI	Arbor	282
Wood effect	Badia	292
Imitation boi	Wooder	298
Holz-optik		

Simbologia

Symbology / Symboles / Symbole

PITTOGRAMMI DI TECNOLOGIA

Pictograms for the technological features /
Pictogrammes de la technologie /
Technologiebilderschriftzeichen



Bla

Gres porcellanato con colorazione in massa
Porcelained stoneware with mass colouring
Grès cérame avec pate colorée
Durchgefärbtes feinsteinzeug



Bla

Gres porcellanato smaltato
Glazed stoneware
Grès cérame émaillé
Glasiertes Feinsteinzeug

PITTOGRAMMI DI IDENTIFICAZIONE DELLE CARATTERISTICHE TECNICHE DEL PRODOTTO

Pictograms showing the different product technical features /
Pictogrammes pour l'identification des caractéristiques techniques des produits /
Bilderschriftzeichen für die kennzeichnung der technischen eigenschaften des produktes



V1 / V2 / V3 / V4

Variazioni cromatiche
Colour variations
Variations chromatiques
Farbvariationen



Fattore di resistenza alla scivolosità
Anm-skeed resistance grade
Gré de resistance à la glissance
Rutschfestigkeit



Fuga minima consigliata
Advised minimum joint
Joint minimal conseille
Empfahlte Fuge



Posa consigliata sfalsata a 1/4 per formati rettangolari
Installation recommended staggered to run at 1/4
Pose recommandé a suivre decalée de 1/4
Empfohlene Verlegung: Viertelverband versetzt bei rechteckigen Formaten



Spessore
Thickness
Epaisseur
Dicke



Nelle zone ad alto traffico si consiglia l'uso esclusivamente a rivestimento
In heavy traffic areas we suggest the use only as wall application /
Dans les zones à trafic intense, il est conseillé de n'utiliser le produit que pour le revêtement de murs /
In Bereichen mit hoher Trittbelastung sollte das Produkt ausschließlich als Wandverkleidung eingesetzt werden

Alfalux world

IT / Alfalux nasce dalla fusione tra gli storici marchi Alfa e Lux, all'interno dell'azienda ceramica Nuova Riwal. Nuova Riwal ha sede nel comprensorio ceramico di Sassuolo: con i marchi Alfalux e Saime rappresenta uno dei gruppi più importanti del settore nella produzione e commercializzazione di ceramiche per pavimenti e rivestimenti in gres porcellanato con colorazione in massa e gres porcellanato smaltato. Dal 2007 Nuova Riwal appartiene a un gruppo tra i più rinomati leader di settore della produzione ceramica: Casalgrande Padana S.p.A., che ha sede a Casalgrande di Reggio Emilia.

EN / The Group and the company

Alfalux comes from the merger of the historical brands Alfa and Lux, within the Nuova Riwal ceramics company. Nuova Riwal has its headquarters in the ceramic district of Sassuolo: with the brands Alfalux and Saime, it represents one of the largest groups working in the production and marketing of floor and wall coverings in porcelain stoneware with full-body colouring and glazed porcelain stoneware. In 2007, Nuova Riwal joined one of the most renowned and leading groups in the ceramic production sector: Casalgrande Padana S.p.A., with headquarters in Casalgrande, Reggio Emilia.

FR / Le groupe et l'entreprise

Alfalux est née de la fusion des marques historiques Alfa et Lux, au sein de l'entreprise céramique Nuova Riwal. Nuova Riwal a son siège dans le district céramique de Sassuolo : avec les marques Alfalux et Saime, elle représente l'un des groupes les plus importants du secteur dans la production et la commercialisation de carreaux de sol et de mur en grès cérame teinté masse et émaillé. Depuis 2007, Nuova Riwal appartient à l'un des groupes les plus renommés dans le secteur de la fabrication de céramiques: Casalgrande Padana S.p.A., ayant son siège à Casalgrande di Reggio Emilia.

DE / Der Konzern und das Unternehmen

Alfalux entsteht aus dem Zusammenschluss der bekannten Marken Alfa und Lux innerhalb des Keramikunternehmens Nuova Riwal. Der Firmensitz von Nuova Riwal befindet sich im Keramikdistrikt von Sassuolo: Mit den Marken Alfalux und Saime ist das Unternehmen branchenweit einer der bedeutendsten Hersteller und Vermarkter von keramischen Boden- und Wandbelägen aus durchgefärbtem Feinsteinzeug und aus glasiertem Feinsteinzeug. Seit 2007 gehört Nuova Riwal zu einem der anerkanntesten führenden Konzerne der Keramikbranche: Casalgrande Padana S.p.A., mit Sitz in Casalgrande di Reggio Emilia.



Il gruppo e l'azienda

La ceramica come Materia

IT / Renzo Piano diceva che la ceramica è un materiale antico che viene dalla terra. Un materiale di eccellente resistenza, durata, e dalle infinite possibilità cromatiche. Riflette la luce rendendola funzionalmente perfetta per ogni sua destinazione. Per questo la ceramica è protagonista della città e della casa moderna.

La materia ceramica è nobile, naturale e performante: sceglierla nella moderna progettazione significa scegliere sostenibilità, resistenza e sicurezza.

Le sollecitazioni chimiche e meccaniche non la intaccano, non brucia e non rilascia sostanze nocive: è un materiale duraturo e completamente riciclabile, privo di plastica per sua stessa natura.

EN / Ceramics as matter

Renzo Piano said that ceramics are ancient materials that come from the earth. Exceptionally strong and lasting materials with infinite colour possibilities. They reflect the light, which makes them functionally ideal for all uses.

This is why ceramics feature significantly in cities and modern homes.

Ceramic material is noble, natural and high-performing: choosing it for modern designs means choosing sustainability, strength and safety. It is not affected by chemical or mechanical stress, it does not burn or give off harmful substances: it is a lasting, fully recyclable material that by nature contains no plastic.

FR / La céramique en tant que matériau

Renzo Piano a déclaré que la céramique est un matériau ancien qui vient de la terre.

C'est un matériau d'une excellente résistance,

d'une grande durabilité et d'une infinité de possibilités de couleurs. Elle reflète la lumière, ce qui la rend parfaitement fonctionnelle pour tous

les usages. C'est pourquoi la céramique est le protagoniste de la ville et de la maison moderne.

La céramique est un matériau noble, naturel et performant: la choisir dans un design moderne, c'est choisir la durabilité, la résistance et la sécurité. Les contraintes chimiques et mécaniques ne l'affectent pas, elle ne brûle pas et ne dégage pas de substances nocives: c'est un matériau durable et entièrement recyclable, sans plastique par nature.

DE / Keramik als Materie

Renzo Piano hat einmal gesagt, Keramik sei ein antikes Material, das aus der Erde kommt. Ein Material mit hervorragender Belastungsfähigkeit, Lebensdauer und unendlich vielen Farbmöglichkeiten. Es reflektiert Licht und wird damit zu einem funktional perfekten Material für jede Art der Nutzung.

Aus diesem Grund spielt Keramik in der modernen Stadt und im modernen Heim eine tragende Rolle. Die Materie Keramik ist edel, natürlich und leistungsfähig: Wer bei der modernen Planung Keramik wählt, entscheidet sich für Nachhaltigkeit, Belastbarkeit und Sicherheit. Keramik nimmt durch chemische und mechanische Beanspruchung keinen Schaden, ist nicht entflammbar und entwickelt keine Schadstoffe: Das Material besitzt eine lange Lebensdauer, ist vollständig recycelbar und von Natur aus kunststofffrei.

IT / La ceramica è un materiale incorruttibile e leggero, che si rinnova costantemente. La ricerca contemporanea e le nuove tecnologie hanno portato la ceramica a un livello estetico e funzionale senza precedenti. Il know-how acquisito negli anni ha permesso ad Alfalux di raggiungere una poliedrica capacità produttiva, con formati che vanno da spessore 6 mm fino a 20 mm, indoor e outdoor, e dimensioni dalle più piccole, 15x15, fino alle lastre grandi formato, 160x320. A questo si aggiungono le elevate caratteristiche tecniche delle superfici, da Roc e Grip, fino al marmo lucido con effetto completamente specchiato. Soluzioni che rispondono a qualunque necessità di progettisti e clienti.

EN / Technological innovation

Ceramics are light and enduring, and are constantly renewed. Contemporary research and new technologies have brought ceramics to an unprecedented level of function and beauty.

The know-how gained over the years has allowed Alfalux to achieve a multi-purpose production capacity, with formats running from 6 mm to 20 mm thick, for indoor and outdoor use, and sizes from the smallest - 15x15 - to the largest slabs, 160x320.

In addition to this, the surfaces assure the highest technical characteristics, from roc and grip to mirror-polished marble. Solutions that meet every need of designers and customers.

FR / Innovation technologique

La céramique est un matériau incorruptible et léger qui se renouvelle constamment.

La recherche contemporaine et les nouvelles

technologies ont porté la céramique à un niveau esthétique et fonctionnel sans précédent. Le savoir-faire acquis au fil des ans a permis à Alfalux d'atteindre une capacité de production polyvalente, avec des formats allant de 6 mm à 20 mm d'épaisseur, pour l'intérieur et l'extérieur, et des tailles allant du format le plus petit, 15x15, aux dalles de grand format, 160x320.

À cela s'ajoutent les caractéristiques techniques élevées des surfaces, de l'effet pierre au grès antidérapant, jusqu'au marbre poli avec un effet miroir intégral. Des solutions qui répondent à tous les besoins des concepteurs et des clients.

DE / Technische Innovation

Das Material Keramik ist unzerstörbar und leicht und erneuert sich ständig. Die gegenwärtige Forschung und neue Technologien haben die Keramik auf ein vollkommen neues ästhetisches und funktionales Niveau gebracht.

Mit seinem langjährigen Know-how konnte Alfalux mit Formaten mit einer Stärke von 6 bis 20 mm, Ausführungen für den Innen- und den Außenbereich und einem Größenangebot, das von 15x15 bis zu 160x320 reicht, eine vielfältige Produktionskapazität erreichen.

Hinzu kommen die außergewöhnlichen technischen Eigenschaften der Oberflächen von Rutschsicherheit und Haftung bis zu glänzendem Marmor mit Spiegeleffekt. Lösungen, die sämtliche Planungs- und Kundenanforderungen befriedigen können.



Innovazione tecnologica



La ricerca estetica

IT / La competenza dei laboratori di ricerca Alfalux raggiunge elevate prestazioni tecniche, e trasforma l'industria in fabbrica di bellezza, in innovazione tecnologica, esperienziale e culturale.

La creatività artistica si fonde con quella industriale, l'innovazione tecnologica con la ricerca estetica.

La competenza dei nostri laboratori si esprime nella bellezza dei dettagli. Gli effetti del marmo e della pietra sono riprodotti fedelmente con una resa grafica eccezionale. Infinite varianti di texture e disegni sono il risultato di ricerca avanzata, tecnologie innovative, scelte sostenibili, per rispondere a qualunque esigenza di progetto con la migliore soluzione.

EN / Aesthetic research

The competence of the Alfalux research laboratories assure high technical performance, transforming the industry into a factory of beauty and the innovation of technology, experience and culture.

Artistic creativity blends with industrial know-how, technological innovation with aesthetic research. The competence of our laboratories is expressed through the beauty of our detail.

Marble and stone effects are faithfully reproduced with exceptional graphic quality. Infinite texture and pattern variants are the result of in-depth research, innovative technologies, sustainable choices, responding to any design need with the best solution.

FR / Recherche esthétique

L'expertise des laboratoires de recherche d'Alfalux permet d'atteindre des performances techniques élevées et de transformer l'industrie en une usine de

beauté, dans le cadre d'innovations technologiques, expérientielles et culturelles.

La créativité artistique fusionne avec la créativité industrielle, l'innovation technologique avec la recherche esthétique. Le savoir-faire de nos ateliers se reflète dans la beauté des détails.

Les effets du marbre et de la pierre sont fidèlement reproduits avec un rendu graphique exceptionnel. Les variations infinies de textures et de dessins sont le fruit d'une recherche avancée, de technologies innovantes, de choix durables, pour répondre au mieux aux exigences de chaque projet.

DE / Ästhetische Forschung

Die Kompetenz der Forschungslabore von Alfalux erzielt hohe technische Leistungen und verwandelt die Industrie in eine Schönheitsfabrik, in technologische, empirische und kulturelle Innovation.

Künstlerische und industrielle Kreativität, technologische Innovation und ästhetische Forschung verschmelzen miteinander.

Die Kompetenz unserer Forschungslabore kommt in der Schönheit der Details zum Ausdruck.

Der Effekt von Marmor und Stein wurde mit einer außergewöhnlichen Grafik originalgetreu nachempfunden. Endlos viele Texturvarianten und Muster sind das Ergebnis modernster Forschung, innovativer Technologien und nachhaltiger Entscheidungen. Damit für jede Projektanforderung die beste Lösung geboten werden kann.

IT / La progettualità di oggi non vuole confini, non desidera essere ingabbiata e cerca la massima libertà d'espressione. Le collezioni Alfalux si combinano tra loro per valicare confini e giocare con la materia: pietra, legno, marmo e cemento si intrecciano per creare un'identità unica e ricercata. La possibilità di combinare, mescolare, contaminare le collezioni permette di definire e aggiungere un'impronta personale al proprio progetto. Un concept innovativo per uscire da schemi rigidi e dare libera espressione alla creatività, ricercare uno stile personale sempre fondato sull'innovazione, la tecnologia e la sostenibilità Alfalux.

EN / Endless combinations: mix&match

Today, design knows no boundaries, it escapes confinement and seeks full freedom of expression. The Alfalux collections work together to cross borders and play with matter: stone, wood, marble and concrete blend to create a unique, sophisticated identity.

The possibility to combine, mix and match the collections allows you to define and add a personal touch to any project.

An innovative concept that thinks outside the box, offering free expression for creativity, seeking a personal style based on Alfalux innovation, technology and sustainability.

FR / Combinaisons infinies: mix&match

La conception d'aujourd'hui rejette l'idée d'avoir des frontières, ne veut pas être enfermée dans des cages et recherche une liberté d'expression maximale. Les collections Alfalux franchissent les frontières et jouent avec les matériaux: la pierre, le bois, le marbre et le béton s'entremêlent pour créer une identité unique et raffinée.

La possibilité de combiner, de mélanger et de contaminer les collections vous permet de définir et d'ajouter une touche personnelle à votre projet. Un concept innovant pour sortir des schémas rigides et donner libre cours à la créativité, à la recherche d'un style personnel toujours basé sur l'innovation, la technologie et la durabilité Alfalux.

DE / Endlose Kombinationen: mix&match

Die Kompetenz der Forschungslabore von Alfalux erzielt hohe technische Leistungen und verwandelt die Industrie in eine Schönheitsfabrik, in technologische, empirische und kulturelle Innovation.

Künstlerische und industrielle Kreativität, technologische Innovation und ästhetische Forschung verschmelzen miteinander. Die Kompetenz unserer Forschungslabore kommt in der Schönheit der Details zum Ausdruck.

Der Effekt von Marmor und Stein wurde mit einer außergewöhnlichen Grafik originalgetreu nachempfunden. Endlos viele Texturvarianten und Muster sind das Ergebnis modernster Forschung, innovativer Technologien und nachhaltiger Entscheidungen. Damit für jede Projektanforderung die beste Lösung geboten werden kann.

Infinite combinazioni: mix&match



Al servizio dell' architettura



IT / La ceramica si apre a nuove destinazioni d'uso, conquistando l'ambito architettonico e i grandi progetti dell'edilizia pubblica, commerciale e industriale. La ricerca estetica e le elevate prestazioni del materiale hanno assicurato alle collezioni Alfalux utilizzi sia nelle pavimentazioni che nei rivestimenti

di pareti e superfici. Progetti di architettura che hanno trovato nella nostra ceramica la soluzione più performante, in grado di coniugare tecnologia ed estetica.

Le nostre soluzioni innovative per i rivestimenti di facciata qualificano gli involucri architettonici con elevate prestazioni di autopulizia e abbattimento degli agenti inquinanti.

EN / Serving architecture

Ceramics open up to new uses. Ceramic design has conquered the world of architecture and large-scale public, commercial and industrial building works. The aesthetic research and high performances of the material allow Alfalux collections to be used for both wall and floor coverings. Architecture projects have found our ceramics to be the highest-performing solution that blends technology and beauty. Our innovative solutions for façade coverings are used to create architectural cladding with high-performing, self-cleaning and pollutant-reducing functions.

FR / Au service de l'architecture

La céramique s'ouvre à de nouveaux usages. Le design céramique a conquis la sphère architecturale et les grands projets de construction publics, commerciaux et industriels. La recherche esthétique et les hautes performances de ce matériau ont permis aux collections Alfalux d'être utilisées aussi bien pour les revêtements de sol que pour les revêtements de murs et de surfaces. Des projets architecturaux qui ont trouvé dans nos céramiques la solution la plus performante, capable d'allier technologie et esthétique. Nos solutions innovantes de revêtement de façade permettent de qualifier les enveloppes architecturales avec des performances élevées en matière d'autonettoyage et de réduction des polluants.

DE / Zu Diensten der Architektur

Keramik öffnet sich neuen Einsatzmöglichkeiten. Das Keramikdesign hat die Architektur und die großen Projekte des öffentlichen, kommerziellen und industriellen Bauwesens erobert. Dank ihrer ansprechenden Optik und der hohen Leistungsfähigkeit ihres Materials haben die Kollektionen von Alfalux sowohl als Bodenbelag wie auch als Wand- und Oberflächenverkleidung Anwendung gefunden: architektonische Projekte, die in unserer Keramik die leistungsstärkste Lösung gefunden haben, welche in der Lage ist, Technologie und Ästhetik miteinander zu verbinden. Unsere innovativen Lösungen für Fassadenverkleidungen qualifizieren sich durch leistungsstarke Ergebnisse im Bereich Selbstreinigung und Schadstoffbekämpfung.

IT / La sostenibilità ambientale incontra la produzione ceramica: nasce una ceramica dall'anima verde. Il suo processo produttivo non rilascia elementi tossici nell'ambiente, non produce emissioni o prodotti di scarto. La massima efficienza di produzione di Alfalux si sposa con il minimo impatto ambientale, frutto di un costante investimento in ricerca e tecnologia. Una tecnologia ceramica ecosostenibile per un prodotto che raggiunge ambiziosi traguardi di design e bellezza, resistenza e versatilità, con un'etica di produzione green e naturale. La ceramica Alfalux nasce da una cultura della materia che affonda le sue radici nel rispetto dell'ambiente, nella costante ricerca di soluzioni innovative e nel più orgoglioso Made in Italy.

EN / Looking to the future

Environmental sustainability meets ceramic production, to create ceramics with a green soul. The production process does not release any toxic substances into the environment, does not produce emissions or waste products.

Alfalux's full production efficiency blends with its minimal environmental impact, the result of constant investments in research and technology. An eco-sustainable ceramic technology for a product that meets ambitious targets in terms of design and beauty, strength and versatility, with a natural, green production ethic. Alfalux ceramics come from a culture of matter rooted in the respect for the environment, constant research for innovative solutions and the proudest Italian manufacturing techniques.

FR / Un aperçu de l'avenir

La durabilité environnementale rencontre la production de céramique: une céramique à l'âme verte est née. Son processus de production ne libère aucun élément toxique dans l'environnement, ne produit aucune émission ni aucun déchet.

L'efficacité maximale de la production d'Alfalux est combinée à un impact minimal sur l'environnement, résultat d'un investissement constant dans la recherche et la technologie. Une technologie céramique éco-durable pour un produit qui atteint des objectifs ambitieux de design et de beauté, de résistance et de polyvalence, avec une éthique de production verte et naturelle. Les céramiques Alfalux sont nées d'une culture du matériau ancrée dans le respect de l'environnement, dans la recherche constante de solutions innovantes et dans le Made in Italy le plus fier.

DE / Mit Blick auf die Zukunft

Nachhaltigkeit trifft auf Keramikproduktion: So entsteht eine Keramik mit grüner Seele. Beim Produktionsprozess gelangen keine toxischen Elemente in die Umwelt, und es entstehen keine Emissionen oder Abfallprodukte.

Maximale Produktionseffizienz verschmilzt bei Alfalux mit minimaler Umweltbelastung und ist das Ergebnis einer konstanten Investition in Forschung und Technologie.

Eine umweltnachhaltige Keramiktechnologie für ein Produkt, das mit einer grünen und naturbelassenen Produktionsethik in den Bereichen Design und Schönheit, Belastbarkeit und Vielseitigkeit ehrgeizige Ziele erreicht. Keramik von Alfalux entsteht aus einer Materialkultur, die tief mit dem Umweltschutz, mit der konstanten Suche nach innovativen Lösungen und mit dem stolzen Made in Italy verwurzelt ist.

Uno sguardo verso il futuro





Indoor e outdoor senza confini

IT / Gli spazi outdoor sono sempre più concepiti per essere coerenti con lo stile degli spazi interni: i rivestimenti delle superfici connettono indoor e outdoor dissolvendo i confini, garantendo continuità e armonia.

Molte collezioni Alfalux nascono per essere scelte sia per gli interni che per gli esterni, con materiali progettati per la posa outdoor.

Il Total Outdoor Alfalux si declina in diversi colori e finiture per completare al meglio le aree esterne di ambienti privati e commerciali. I diversi spessori permettono di giocare con le soluzioni di posa per dare continuità tra gli ambienti.

Giardini, terrazzi, percorsi carrabili, camminamenti in spiaggia: per ogni contesto esiste la perfetta collezione ceramica!

EN / Indoors and outdoors, with no boundaries

Outdoor spaces are increasingly designed to be coherent with the style of the indoor spaces: floor coverings connect indoor and outdoor areas, eliminating boundaries and guaranteeing continuity and harmony.

Many Alfalux collections are designed for both indoor and outdoor uses, with materials suited for outdoor laying.

Alfalux Total Outdoor comes in different colours and finishes to complete outdoor areas of both private and commercial spaces in the best possible way. The various thicknesses can be used to play with laying solutions, offering continuity between spaces. Gardens, terraces, drives, beach paths: there is a perfect ceramic collection for every context!

FR / Continuité entre intérieur et extérieur

Les espaces extérieurs sont de plus en plus conçus pour être cohérents avec le style des espaces intérieurs: les revêtements de surface relient les espaces intérieurs et extérieurs en

supprimant les frontières, en assurant la continuité et l'harmonie.

De nombreuses collections d'Alfalux sont réalisées pour être utilisées à la fois à l'intérieur et à l'extérieur, avec des matériaux conçus pour l'installation en extérieur. Alfalux Total Outdoor se décline en différentes couleurs et finitions pour compléter les espaces extérieurs des environnements privés et commerciaux. Les différentes épaisseurs permettent de jouer avec les solutions de pose pour assurer la continuité entre les espaces. Jardins, terrasses, voies d'accès, trottoirs de plage: pour chaque contexte, il y a la collection de céramiques idéale!

DE / Grenzenlos: Indoor und Outdoor

Außenbereiche werden immer öfter im selben Stil wie der Innenbereich gestaltet: Die Oberflächenverkleidungen verbinden Indoor und Outdoor, verwischen die Grenzen und gewährleisten dadurch Kontinuität und Harmonie. Zahlreiche Kollektionen von Alfalux werden gleichermaßen für den Innen- wie für den Außenbereich konzipiert und mit Materialien hergestellt, die sich für die Outdoorverlegung eignen. Das Total-Outdoor-Konzept von Alfalux ist in verschiedenen Farben und Ausführungen erhältlich, um die Außenbereiche von privaten Wohnhaushalten wie von kommerziell genutzten Räumlichkeiten als perfektes Pendant zum Innenbereich gestalten zu können. Die verschiedenen Stärken ermöglichen einen spielerischen Umgang mit unterschiedlichen Verlegungstechniken für Kontinuität zwischen den Bereichen. Gärten, Terrassen, Zufahrten und Fußwege zum Strand: Für jeden Ort gibt es die perfekte Keramikkollektion!

le Collezioni

The collections / Les Collections/ Die Kollektionen



le Tinte

Paint Effect
Imitation couleur
Farboptik

Pastelli 32
Vibes 46

Pastelli

Gres Smaltato

Glazed stoneware
Grès cérame émaillé
Glasiertes Feinsteinzeug

Spessore / Thickness



6 MM

Finiture / Finishes

RT M / Rettificato Matt
RT T / Rettificato Tech



Bla



V1



fuga
2MM
Rett



Per le zone a traffico più intenso si consiglia l'uso della superficie tech a pavimento.

For floors with high intensity traffic we advise the use of the new finish PASTELLI TECH.

Pour les zones où le trafic est plus intense nous recommandons l'utilisation de la surface tech au sol.

Fuer die Bodenbeläge in hoch frequentierten Bereiche empfehlen wir unsere TECH Ausführung.

Bia GL

CE

Packaging pag. 310

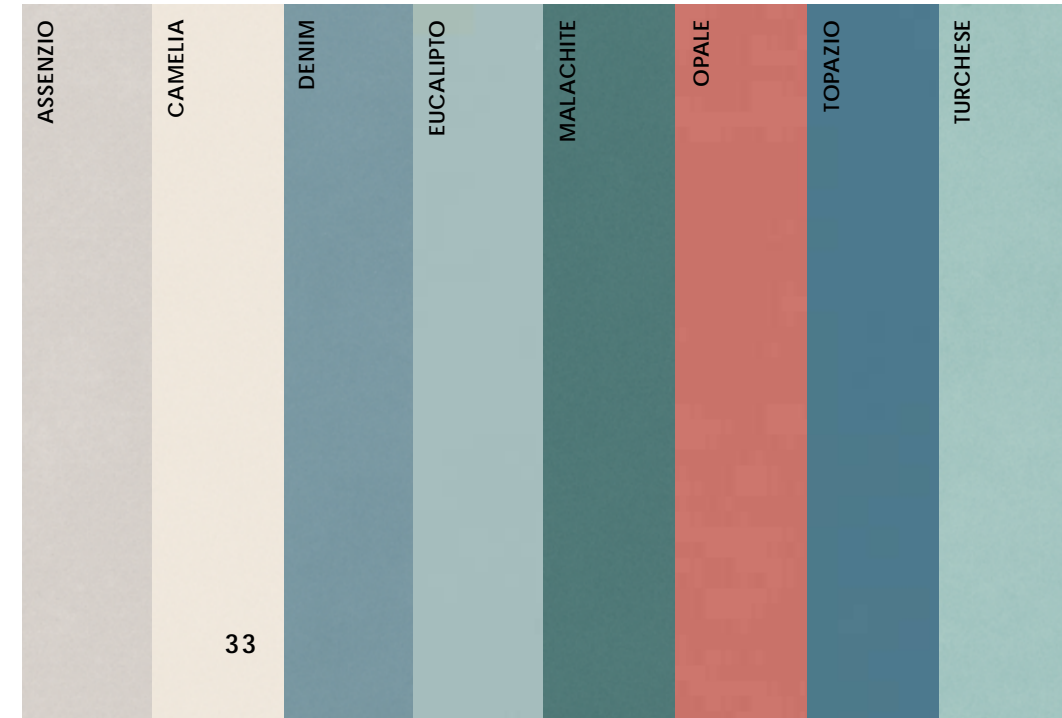
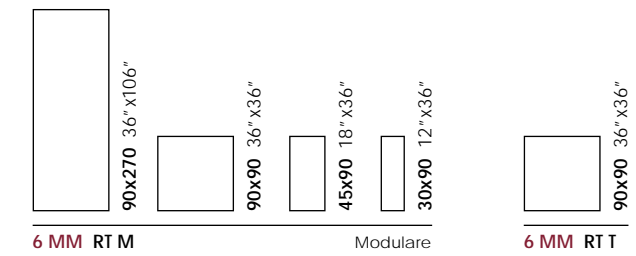



PASTELLI
Denim 90x90 36"x36" Rett Tech
VIBES
Talc 8,2x25 3,22"x9,84" Matt/Shiny



PASTELLI Opale 90x270 36"x106", 30x90 12"x36" Rett Matt
BADIA Frassino 20x120 8"x47" Rett



PASTELLI
Eucalipto 90x270 36"x106" Rett Matt
GARDA
Lazise 60x120 24"x47" Rett Matt

Pastelli

ASSENZIO



6 MM

RETT

90x270 36"x106"
T202505 Matt

90x90 36"x36"
T202585 Matt
T202507 Tech

45x90 18"x36"
T202665 Matt

30x90 12"x36"
T202745 Matt



Decoro Tiarè RETT
90x270 36"x106"
T202510 Matt

Coordinato con tutti i colori
Matching with all colours



6 MM

Mosaico NON RETT
30x30 12"x12"
T222966



6 MM

Muretto NON RETT
30x30 12"x12"
T222967

CAMELIA

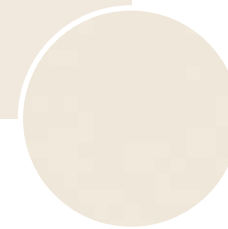
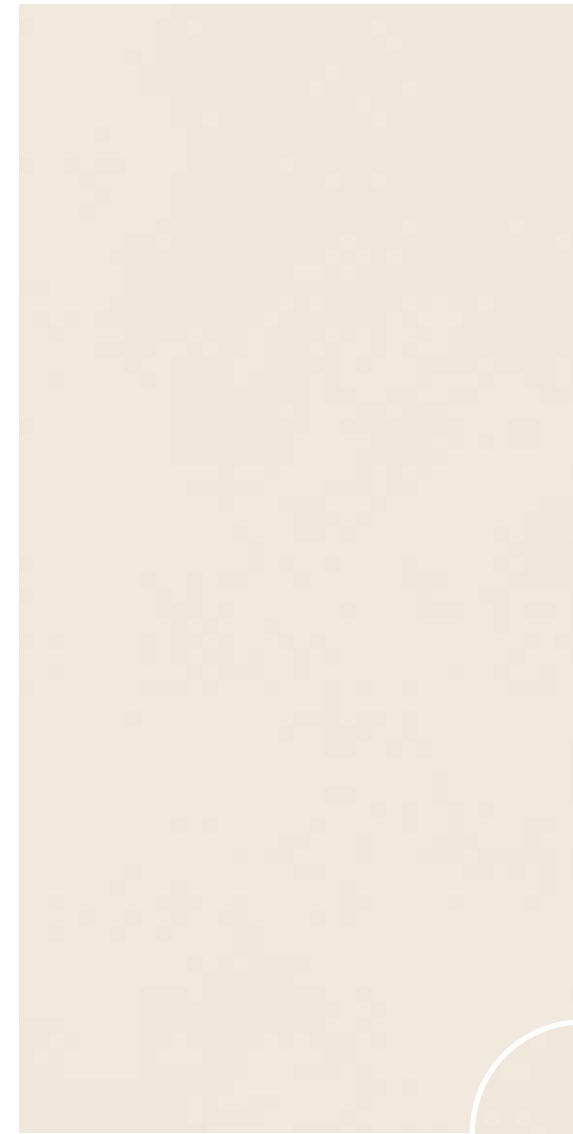

6 MM

RETT

90x270 36"x106"
T202575 Matt

90x90 36"x36"
T202655 Matt
T202577 Tech

45x90 18"x36"
T202735 Matt

30x90 12"x36"
T202815 Matt



6 MM

Mosaico NON RETT
30x30 12"x12"
T222816



6 MM

Muretto NON RETT
30x30 12"x12"
T222817

Pastelli

LE TINTE

DENIM

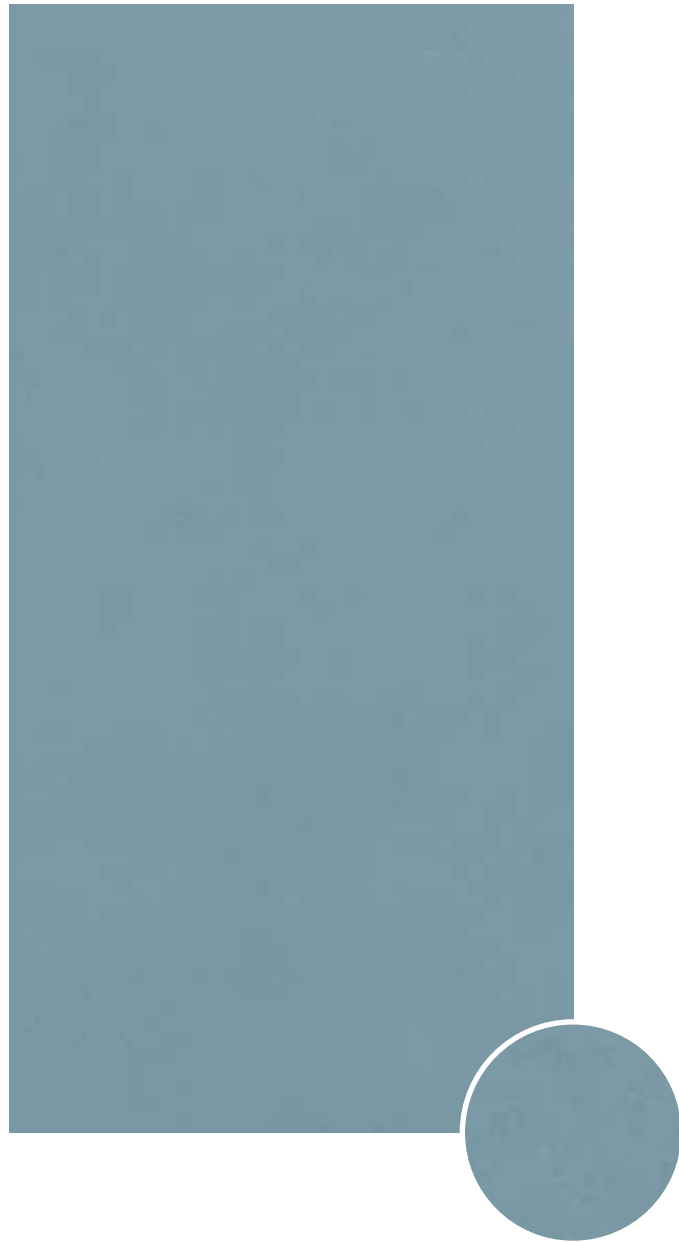

6 MM

RETT

90x270 36"x106"
T202515 Matt

90x90 36"x36"
T202595 Matt
T202517 Tech

45x90 18"x36"
T202695 Matt

30x90 12"x36"
T202775 Matt

EUCALIPTO



6 MM

RETT

90x270 36"x106"
T202525 Matt

90x90 36"x36"
T202605 Matt
T202527 Tech

45x90 18"x36"
T202705 Matt

30x90 12"x36"
T202785 Matt



6 MM

Mosaico NON RETT
30x30 12"x12"
T222926



6 MM

Muretto NON RETT
30x30 12"x12"
T222927



6 MM

Mosaico NON RETT
30x30 12"x12"
T222936



6 MM

Muretto NON RETT
30x30 12"x12"
T222937

Pastelli

MALACHITE



6 MM

RETT

90x270 36"x106"
T202555 Matt

90x90 36"x36"
T202635 Matt
T202557 Tech

45x90 18"x36"
T202725 Matt

30x90 12"x36"
T202805 Matt

OPALE



6 MM

RETT

90x270 36"x106"
T202565 Matt

90x90 36"x36"
T202645 Matt
T202567 Tech

45x90 18"x36"
T202675 Matt

30x90 12"x36"
T202755 Matt



6 MM

Mosaico NON RETT
30x30 12"x12"
T222956



6 MM

Muretto NON RETT
30x30 12"x12"
T222957



6 MM

Mosaico NON RETT
30x30 12"x12"
T222906



6 MM

Muretto NON RETT
30x30 12"x12"
T222907

Pastelli

LE TINTE

TOPAZIO

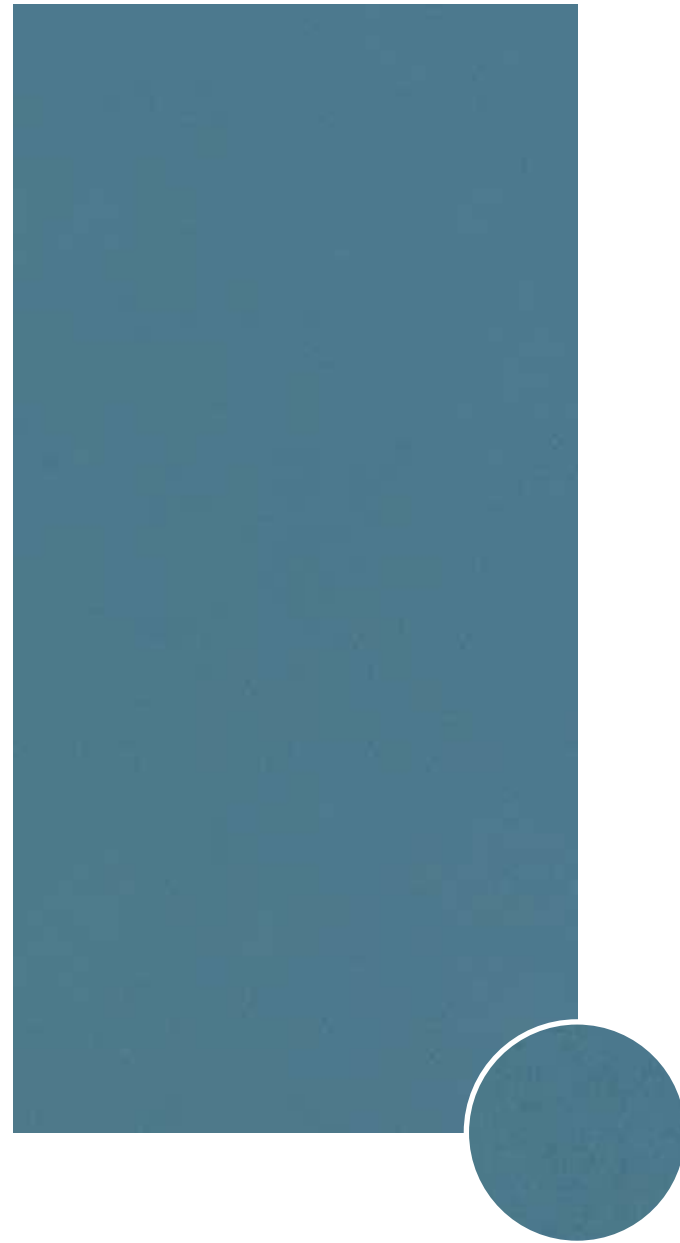

6 MM

RETT

90x270 36"x106"
T202535 Matt

90x90 36"x36"
T202615 Matt
T202537 Tech

45x90 18"x36"
T202715 Matt

30x90 12"x36"
T202795 Matt

TURCHESE



6 MM

RETT

90x270 36"x106"
T202545 Matt

90x90 36"x36"
T202625 Matt
T202547 Tech

45x90 18"x36"
T202685 Matt

30x90 12"x36"
T202765 Matt



6 MM

Mosaico NON RETT
30x30 12"x12"
T222946



6 MM

Muretto NON RETT
30x30 12"x12"
T222947



6 MM

Mosaico NON RETT
30x30 12"x12"
T222916



6 MM

Muretto NON RETT
30x30 12"x12"
T222917

Vibes

Gres Smaltato

Glazed stoneware
Grès cérame émaillé
Glasiertes Feinsteinzeug

Spessore / Thickness



9 MM

Finiture / Finishes

NRT M / Non Rettificato Matt
NRT SH / Non Rettificato Shiny

SUPERFICIE SHINY

Trattandosi di un materiale realizzato con materie prime particolarmente pregiate, si sconsiglia l'utilizzo di detersivi e materiali con effetto abrasivo nella gestione della pulizia post-cantiere e di ordinaria manutenzione.

SURFACE SHINY

This range is produced with high quality raw materials, therefore please do not use abrasive detergents nor scratching tools for cleaning and daily maintenance

SHINY SURFACE

Étant un matériau fabriqué avec des matières premières particulièrement précieuses, nous déconseillons l'utilisation de détergents et de matériaux à effet abrasif dans la gestion du nettoyage post-construction et de l'entretien courant

OBERFLAECHE SHINY

aufgrund der besonders wertvollen verwendeten Rohstoffe ist die Benutzung von aggressiven Reinigungsmitteln bei der Erst- und taeglichen Reinigung zu vermeiden.



Bla



V2



fuga
> 3MM
Non Rett

Bia GL

CE

Packaging pag. 310

8,2x25 3,22"x9,84"

9 MM NRT M/NRT SH

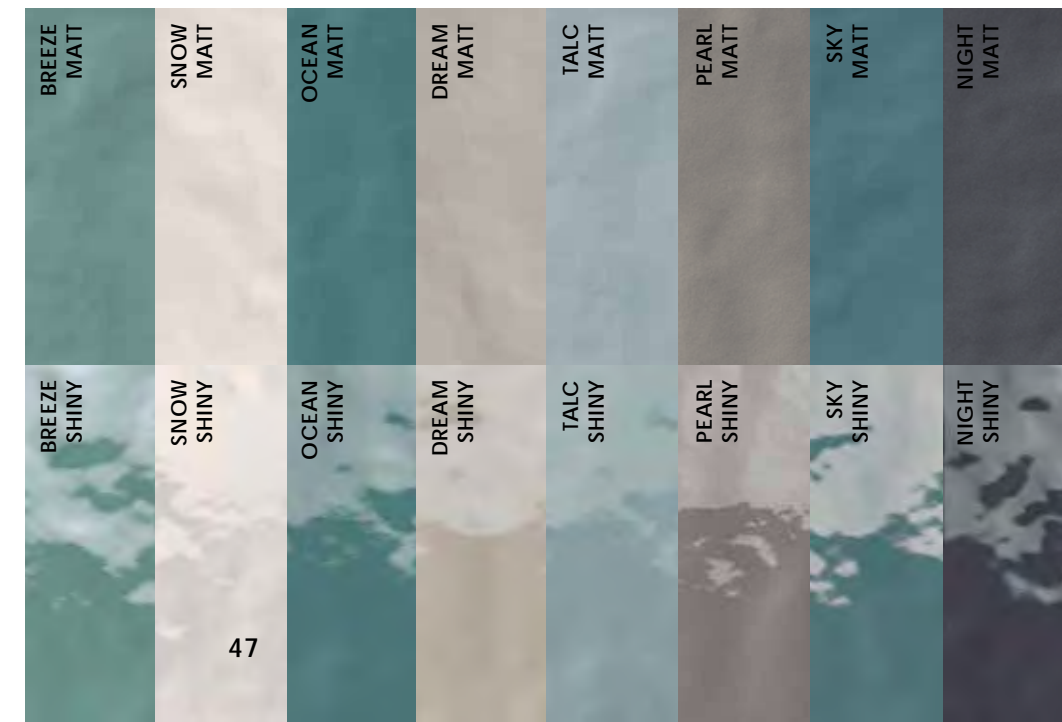



VIBES
Ocean 8,2x25 3,22"x9,84" Shiny
GARDA
Torbole 60x60 24"x24" Rett Matt



VIBES Breeze 8,2x25 3,22"x9,84" Matt/Shiny
GARDA Riva 90x90 36"x36" Rett Matt

Vibes

BREEZE



9 MM

NON RETT

8,2x25 3,22"x 9,84"
7200161 Matt
7200151 Shiny

TALC



9 MM

NON RETT

8,2x25 3,22"x 9,84"
7200181 Matt
7200171 Shiny

OCEAN



9 MM

NON RETT

8,2x25 3,22"x 9,84"
7200141 Matt
7200131 Shiny

SKY



9 MM

NON RETT

8,2x25 3,22"x 9,84"
7200121 Matt
7200111 Shiny

SNOW



9 MM

NON RETT

8,2x25 3,22"x 9,84"
7200261 Matt
7200251 Shiny

PEARL



9 MM

NON RETT

8,2x25 3,22"x 9,84"
7200221 Matt
7200211 Shiny

DREAM



9 MM

NON RETT

8,2x25 3,22"x 9,84"
7200241 Matt
7200231 Shiny

NIGHT

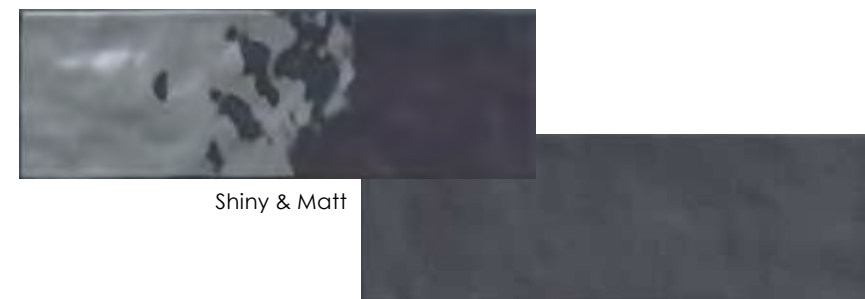

9 MM

NON RETT

8,2x25 3,22"x 9,84"
7200201 Matt
7200191 Shiny

le Pietre

Stone effect
Imitation pierre
Steineffekt

Atlantis	54
Blendstone	68
Cottage	84
Hills	96
Lathemar	104
Neutra Roc	112
Pangea	116
Pietre Pure	130
Stonequartz	142

Atlantis

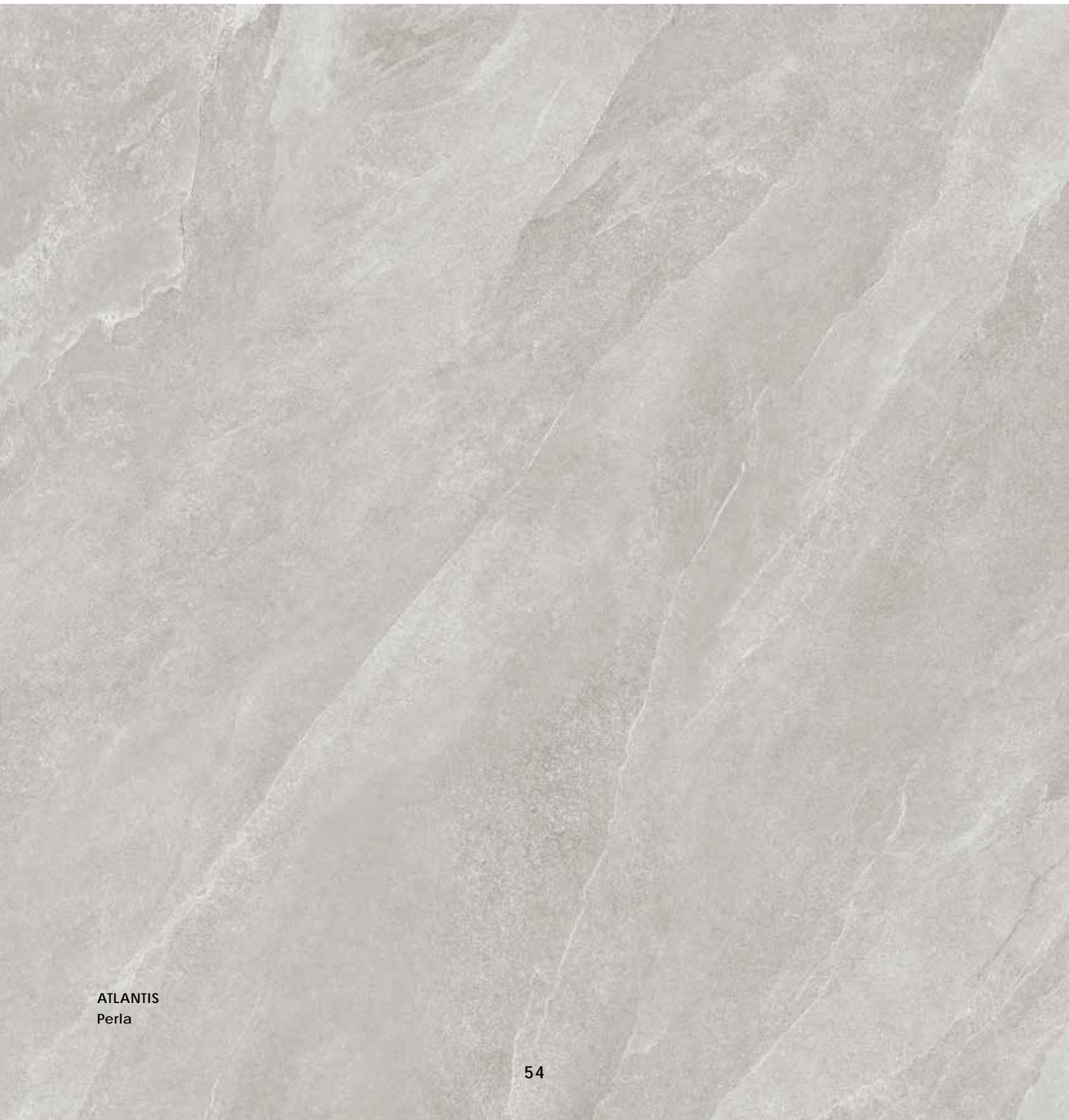

ATLANTIS
Perla

Gres Porcellanato

Porcelained stoneware
Grès cérame
Feinsteinzeug

Spessore / Thickness



20 MM
9 MM
8 MM

Finiture / Finishes

RT / Rettificato
NRT / Non rettificato
RT GR / Rettificato Grip
RT ROC / Rettificato ROC
NRT ROC / Non rettificato ROC

Su richiesta / On demand

Pezzi speciali 20MM /
Trims 20MM

pag. 338



Bla



V3



fuga
2MM
Rett



fuga
> 3MM
Non Rett



R11
GRIP
ROC



A+B+C
GRIP
ROC

Bia GL

CE

Packaging pag. 310

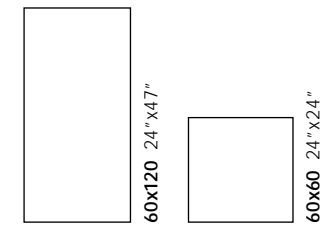

20 MM RT GR Modulare

Only: Fumo, Lava, Perla, Sabbia

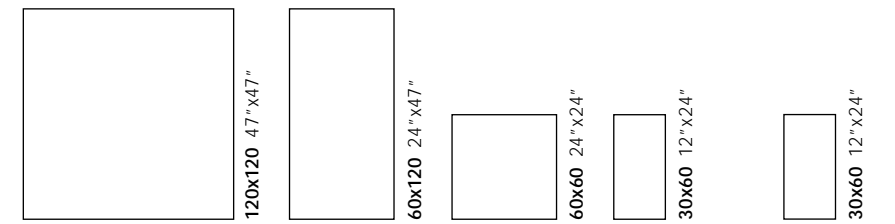

9 MM RT / RT GR

Grip Rett only 60x120 - 60x60 - 30x60

Modulare

9 MM NRT

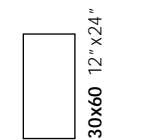

9 MM NRT ROC

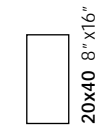

8 MM NRT ROC

Only: Fumo, Perla, Sabbia

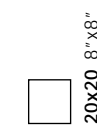

Modulare

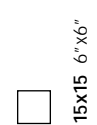

8 MM NRT

Only: Fumo, Perla, Sabbia

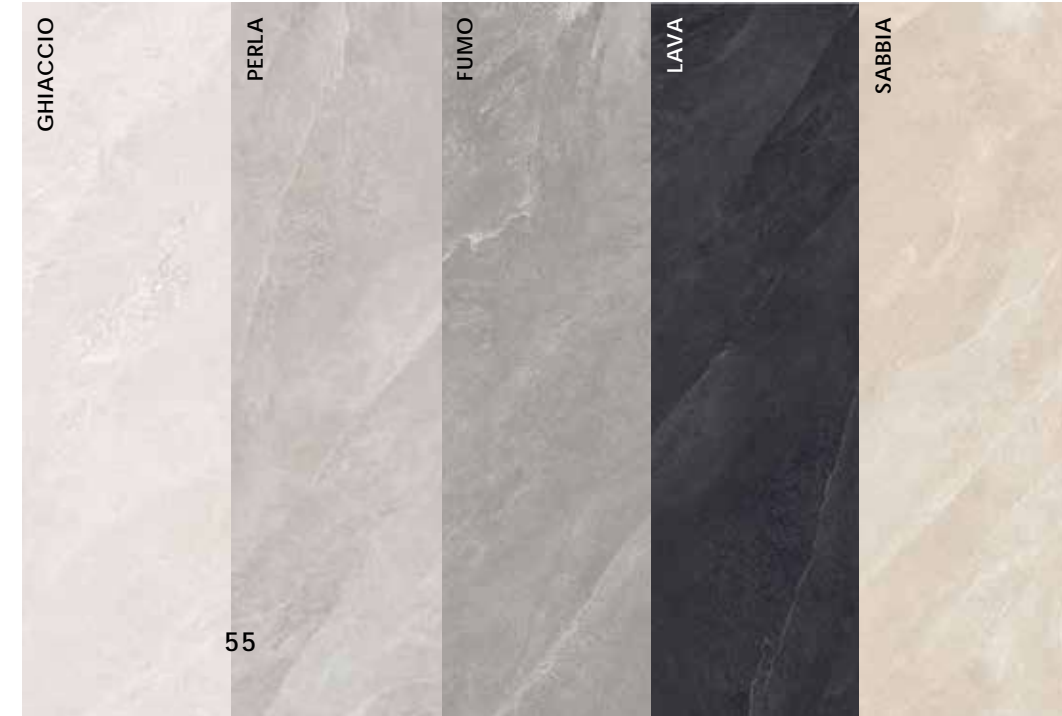



ATLANTIS
Fumo 120x120 47"x47" Rett
Fumo 60x120 sp.20mm 24"x47" Rett Grip
Sabbia 60x120 24"x47" Rett



ATLANTIS
Lava 60x120 24"x47" Rett - mos. 5x5 30x30 12"x12"



ATLANTIS
Perla 60x120 24"x47"
Fumo 60x120 24"x47"
Ghiaccio mos. 5x5 30x30 12"x12"

GHIACCIO



9 MM

RETT

120x120 47"x47"
T200029

60x120 24"x47"
8200112

60x60 24"x24"
8200114

30x60 12"x24"
8200113

NON RETT

30x60 12"x24"
7200015

GRIP RETT

60x120 24"x47"
8200116

60x60 24"x24"
8200117

30x60 12"x24"
8200108

ROC NON RETT

30x60 12"x24"
7200006



9 MM

Mosaico NON RETT
30x30 12"x12"
7278012



9 MM

Esagoni NON RETT
27,4x31,7 10,78"x12,48"
8200781



Battiscopa
RETT
7,5x60 3"x24"
8200226



Elemento ad L
ROC
4x15x30 1,57"x6"x12
7278018

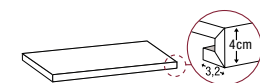

Gradone costa retta
Angolare DX/SX
RETT
33,3x120x4 13"x47"x1,57"
SU RICHIESTA. ON DEMAND.
SUR DEMANDE. AUF ANFRAGE

PERLA



20 MM

GRIP RETT

60x120 24"x47"
8232308

60x60 24"x24"
8232302

9 MM

RETT

120x120 47"x47"
T200031

60x120 24"x47"
8200132

60x60 24"x24"
8200134

30x60 12"x24"
8200133

NON RETT

30x60 12"x24"
7200035

GRIP RETT

60x120 24"x47"
8200128

60x60 24"x24"
8200135

30x60 12"x24"
8200083

ROC NON RETT

30x60 12"x24"
7200008

8 MM

ROC NON RETT

20x40 8"x16"
7278002

20x20 8"x8"
7278006

NON RETT

15x15 6"x6"
7001404



9 MM

Mosaico NON RETT
30x30 12"x12"
7278016



9 MM

Esagoni NON RETT
27,4x31,7 10,78"x12,48"
8200783



Battiscopa
RETT
7,5x60 3"x24"
8200228



Elemento ad L
ROC
4x15x30 1,57"x6"x12
7278009

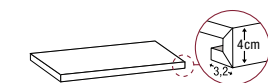

Gradone costa retta
Angolare DX/SX
RETT
33,3x120x4 13"x47"x1,57"
SU RICHIESTA. ON DEMAND.
SUR DEMANDE. AUF ANFRAGE

FUMO

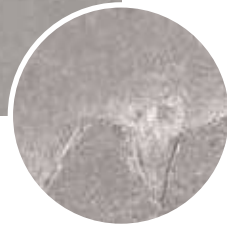

20 MM

GRIP RETT

60x120 24"x47"
8232304

60x60 24"x24"
8232301

9 MM

RETT

120x120 47"x47"
T200028

60x120 24"x47"
8200101

60x60 24"x24"
8200102

30x60 12"x24"
8200103

NON RETT

30x60 12"x24"
7200005

GRIP RETT

60x120 24"x47"
8200105

60x60 24"x24"
8200106

30x60 12"x24"
8200107

ROC NON RETT

30x60 12"x24"
7200004

8 MM

ROC NON RETT

20x40 8"x16"
7278000

20x20 8"x8"
7278004

NON RETT

15x15 6"x6"
7001403



Battiscopa
RETT
7,5x60 3"x24"
8200224

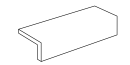

Elemento ad L
ROC
4x15x30 1,57"x6"x12
7278008

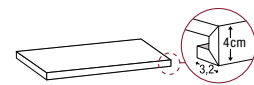

Gradone costa retta
Angolare DX/SX
RETT
33,3x120x4 13"x47"x1,57"
SU RICHIESTA. ON DEMAND.
SUR DEMANDE. AUF ANFRAGE



Mosaico NON RETT
30x30 12"x12"
7278011



Esagoni NON RETT
27,4x31,7 10,78"x12,48"
8200779

LAVA

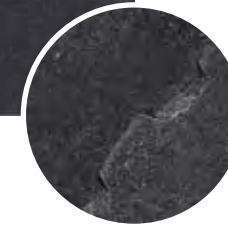

20 MM

GRIP RETT

60x120 24"x47"
8232310

60x60 24"x24"
8232311

9 MM

RETT

120x120 47"x47"
T200030

60x120 24"x47"
8200122

60x60 24"x24"
8200124

30x60 12"x24"
8200123

NON RETT

30x60 12"x24"
7200025

GRIP RETT

60x120 24"x47"
8200125

60x60 24"x24"
8200126

30x60 12"x24"
8200078

ROC NON RETT

30x60 12"x24"
7200007



Battiscopa
RETT
7,5x60 3"x24"
8200227

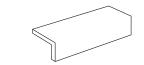

Elemento ad L
ROC
4x15x30 1,57"x6"x12
7278019

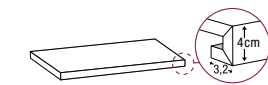

Gradone costa retta
Angolare DX/SX
RETT
33,3x120x4 13"x47"x1,57"
SU RICHIESTA. ON DEMAND.
SUR DEMANDE. AUF ANFRAGE



Mosaico NON RETT
30x30 12"x12"
7278013



Esagoni NON RETT
27,4x31,7 10,78"x12,48"
8200782

Atlantis

SABBIA



9 MM
Mosaico NON RETT
30x30 12"x12"
7278017



9 MM
Esagoni NON RETT
27,4x31,7 10,78"x12,48"
8200784



Battiscopa
RETT
7,5x60 3"x24"
8200233

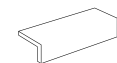

Elemento ad L
ROC
4x15x30 1,57"x6"x12"
7278010

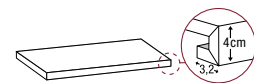

Gradone costa retta
Angolare DX/SX
RETT
33,3x120x4 13"x47"x1,57"
SU RICHIESTA. ON DEMAND.
SUR DEMANDE. AUF ANFRAGE

20 MM

GRIP RETT

60x120 24"x47"
8232309

60x60 24"x24"
8232303

9 MM

RETT

120x120 47"x47"
T200032

60x120 24"x47"
8200144

60x60 24"x24"
8200146

30x60 12"x24"
8200145

NON RETT

30x60 12"x24"
7200045

GRIP RETT

60x120 24"x47"
8200137

60x60 24"x24"
8200138

30x60 12"x24"
8200084

ROC NON RETT

30x60 12"x24"
7200009

8 MM

ROC NON RETT

20x40 8"x16"
7278003

20x20 8"x8"
7278007

NON RETT

15x15 6"x6"
7001405

LE PIETRE



ATLANTIS
Sabbia 60x120 24"x47" Rett, 60x120x2 24"x47"x0,7" Rett Grip
WOODER Clove 20x120 8"x47" Rett



ATLANTIS
Sabbia 20x40 8" x16" - Sabbia 20x20 8" x8"



ATLANTIS
Perla 20x40 8" x16"
Perla 20x20 8" x8"

Blendstone



BLENDSTONE
Beige

Gres Porcellanato

Porcelained stoneware
Grès cérame
Feinsteinzeug

Spessore / Thickness



20 MM
9 MM
8 MM

Finiture / Finishes

RT / Rettificato
NRT / Non rettificato
RT GR / Rettificato Grip
NRT ROC / Non rettificato ROC

Su richiesta / On demand

Pezzi speciali 20MM /
Trims 20MM

pag. 338



Bia



V4



fuga
2MM
Rett



fuga
> 3MM
Non Rett



R11
GRIP
ROC



A+B+C
GRIP
ROC

Bia GL

CE

Packaging pag. 311

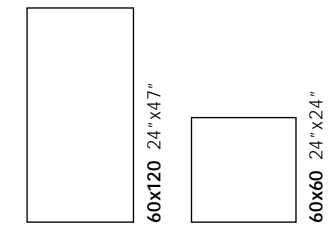

20 MM RT GR Modulare
Only: Beige, Bianco, Grigio

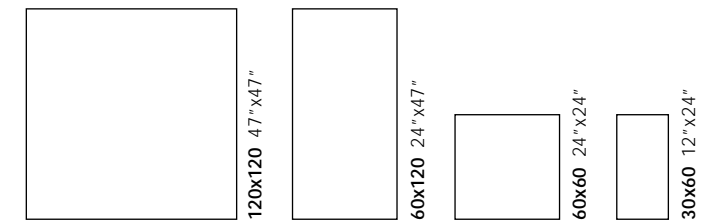

9 MM RT / RT GR Modulare
Grip Rett only 60x120 - 60x60 - 30x60

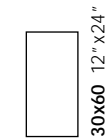

9 MM NRT

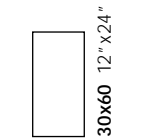

9 MM NRT ROC

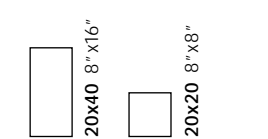

8 MM NRT ROC Modulare





BLENDSTONE
Grigio 120x120 47"x47" Rett, 30x60 12"x24" Rett



BLENDSTONE
Taupe 60x120 24"x47" Rett



BLENDSTONE
Beige 30x60 12"x24" Rett, 60x60 24"x24" Rett



BLENDSTONE
Bianco 60x60 24"x24" Rett, 120x120 47"x47" Rett
MARVILLA
Cellini mosaico 30x30 12"x12" Non Rett

Blendstone

LE PIETRE

BIANCO



20 MM

GRIP RETT

60x120 24"x47"
8232318

60x60 24"x24"
8232314

9 MM

RETT

120x120 47"x47"
8200556

60x120 24"x47"
8200572

60x60 24"x24"
8200583

30x60 12"x24"
8200579

NON RETT

30x60 12"x24"
7200023

GRIP RETT

60x120 24"x47"
8200595

60x60 24"x24"
8200596

30x60 12"x24"
8200594

ROC NON RETT

30x60 12"x24"
7200024

8 MM

ROC NON RETT

20x40 8"x16"
7200014

20x20 8"x8"
7200013

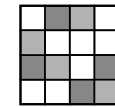

V4

Forti variazioni cromatiche

Strong colour variations
Fortes variations chromatiques
Starke Farbvariationen

IT / In fase di posa, miscelare i pezzi prendendo da diverse scatole.
EN / When laying, mix the pieces from different boxes.
FR / Pose: mélanger les carreaux en les prélevant de différentes boîtes à la fois.
DE / Verlegung: Fliesen aus verschiedenen Fliesenpaketen mischen.

120x120 47"x47"



60x120 24"x47"



60x60 24"x24"



9 MM

Esagoni
NON RETT
27,4x31,7 10,78"x12,48"
8200774



Battiscopa
RETT
7,5x60 3"x24"
8200842

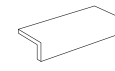

Elemento ad L
GRIP
4x15x30 1,57"x6"x12
7200062

Blendstone

LE PIETRE

BEIGE



20 MM

GRIP RETT

60x120 24"x47"
8232313

60x60 24"x24"
8232312

9 MM

RETT

120x120 47"x47"
8200554

60x120 24"x47"
8200573

60x60 24"x24"
8200578

30x60 12"x24"
8200577

NON RETT

30x60 12"x24"
7200020

GRIP RETT

60x120 24"x47"
8200589

60x60 24"x24"
8200593

30x60 12"x24"
8200588

ROC NON RETT

30x60 12"x24"
7200021

8 MM

ROC NON RETT

20x40 8"x16"
7200011

20x20 8"x8"
7200010

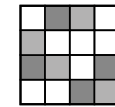

V4

Forti variazioni cromatiche

Strong colour variations
Fortes variations chromatiques
Starke Farbvariationen

IT / In fase di posa, miscelare i pezzi prendendo da diverse scatole.
EN / When laying, mix the pieces from different boxes.
FR / Pose: mélanger les carreaux en les prélevant de différentes boîtes à la fois.
DE / Verlegung: Fliesen aus verschiedenen Fliesenpaketen mischen.

120x120 47"x47"



60x120 24"x47"



60x60 24"x24"



9 MM

Esagoni
NON RETT
27,4x31,7 10,78"x12,48"
8200773



Battiscopa
RETT
7,5x60 3"x24"
8200841

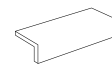

Elemento ad L
GRIP
4x15x30 1,57"x6"x12
7200061

Blendstone

GRIGIO



20 MM

GRIP RETT

60x120 24"x47"
8232321

60x60 24"x24"
8232319

9 MM

RETT

120x120 47"x47"
8200558

60x120 24"x47"
8200574

60x60 24"x24"
8200585

30x60 12"x24"
8200584

NON RETT

30x60 12"x24"
7200026

GRIP RETT

60x120 24"x47"
8200598

60x60 24"x24"
8200599

30x60 12"x24"
8200597

ROC NON RETT

30x60 12"x24"
7200027

8 MM

ROC NON RETT

20x40 8"x16"
7200017

20x20 8"x8"
7200016

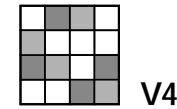

V4

Forti variazioni cromatiche

Strong colour variations
Fortes variations chromatiques
Starke Farbvariationen

IT / In fase di posa, miscelare i pezzi prendendo da diverse scatole.
EN / When laying, mix the pieces from different boxes.
FR / Pose: mélanger les carreaux en les prélevant de différentes boîtes à la fois.
DE / Verlegung: Fliesen aus verschiedenen Fliesenpaketen mischen.

120x120 47"x47"



60x120 24"x47"



60x60 24"x24"

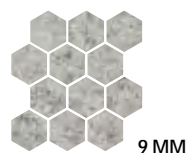

9 MM

Esagoni
NON RETT
27,4x31,7 10,78"x12,48"
8200777



Battiscopa
RETT
7,5x60 3"x24"
8200843

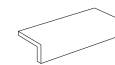

Elemento ad L
GRIP
4x15x30 1,57"x6"x12
7200063

Blendstone

TAUPE



9 MM

RETT

120x120 47"x47"
8200559

60x120 24"x47"
8200576

60x60 24"x24"
8200587

30x60 12"x24"
8200586

NON RETT

30x60 12"x24"
7200028

GRIP RETT

60x120 24"x47"
8200607

60x60 24"x24"
8200606

30x60 12"x24"
8200605

ROC NON RETT

30x60 12"x24"
7200029

8 MM

ROC NON RETT

20x40 8"x16"
7200019

20x20 8"x8"
7200018

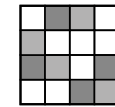

V4

Forti variazioni cromatiche

Strong colour variations
Fortes variations chromatiques
Starke Farbvariationen

IT / In fase di posa, miscelare i pezzi prendendo da diverse scatole.
EN / When laying, mix the pieces from different boxes.
FR / Pose: mélanger les carreaux en les prélevant de différentes boîtes à la fois.
DE / Verlegung: Fliesen aus verschiedenen Fliesenpaketen mischen.

120x120 47"x47"



60x120 24"x47"



60x60 24"x24"

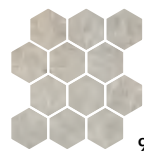

9 MM

Esagoni
NON RETT
27,4x31,7 10,78"x12,48"
8200778



Battiscopa
RETT
7,5x60 3"x24"
8200844

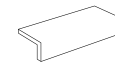

Elemento ad L
GRIP
4x15x30 1,57"x6"x12"
7200064

Cottage



COTTAGE
Milk

Gres Porcellanato

Porcelained stoneware
Grès cérame
Feinsteinzeug

Spessore / Thickness



20 MM
10 MM
9 MM

Finiture / Finishes

RT / Rettificato
RT SI / Rettificato Silk
NRT / Non Rettificato
RT GR / Rettificato Grip
NRT GR / Non Rettificato Grip

Su richiesta / On demand

Pezzi speciali 20MM /
Trims 20MM

pag. 338



Bla



V4



fuga
2MM
Rett



fuga
> 3MM
Nat



R11
GRIP



A+B+C
GRIP

Bia GL

CE

Packaging pag. 311

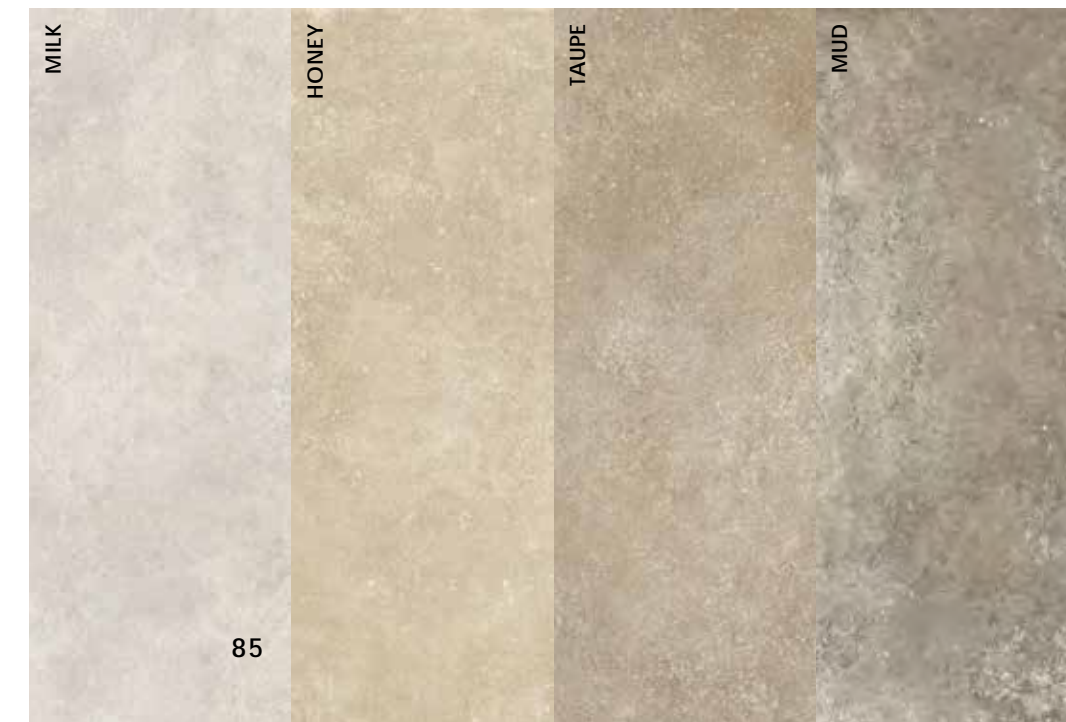



COTTAGE Taupe 60x120 24"x47" Rett
PASTELLI Assenzio 90x270 36"x106" Rett Matt



COTTAGE
Mud 60x60 24"x24" Rett Silk



COTTAGE
Milk 60x120x2 24"x47"x0,7" Rett Grip

Cottage

LE PIETRE

MILK



20 MM

GRIP RETT

60x120 24"x47"
8290001

60x60 24"x24"
8290000

9 MM

RETT

90x90 36"x36"
8290004
8290104 Silk

45x90 18"x36"
8290005
8290105 Silk

9 MM

RETT

60x120 24"x47"
8290009
8290109 Silk

60x60 24"x24"
8290008
8290108 Silk

30x60 12"x24"
8290007
8290107 Silk

GRIP RETT

60x120 24"x47"
8200268

60x60 24"x24"
8200289

30x60 12"x24"
8200298

NON RETT

30x60 12"x24"
7290007

GRIP NON RETT

30x60 12"x24"
7290008



Battiscopa
RETT
7,5x60 3"x24"
8290101

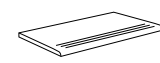

Step
RETT
30x60 12"x24"
8290002

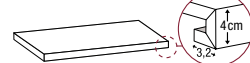

Gradone costa retta
RETT
33,3x120x4
13"x47"x1,57"
8290050
8290055 Silk

Ang. SX
8290052
8290054 Silk

Ang. DX
8290051
8290053 Silk

HONEY

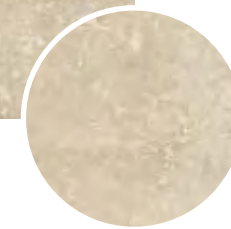

20 MM

GRIP RETT

60x120 24"x47"
8290021

60x60 24"x24"
8290020

9 MM

RETT

90x90 36"x36"
8290024
8290124 Silk

45x90 18"x36"
8290025
8290125 Silk

9 MM

RETT

60x120 24"x47"
8290029
8290129 Silk

60x60 24"x24"
8290028
8290128 Silk

30x60 12"x24"
8290027
8290127 Silk

GRIP RETT

60x120 24"x47"
8200267

60x60 24"x24"
8200288

30x60 12"x24"
8200303

NON RETT

30x60 12"x24"
7290027

GRIP NON RETT

30x60 12"x24"
7290028



Battiscopa
RETT
7,5x60 3"x24"
8290121

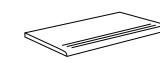

Step
RETT
30x60 12"x24"
8290022

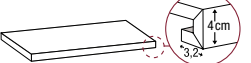

Gradone costa retta
RETT
33,3x120x4
13"x47"x1,57"
8290040
8290045 Silk

Ang. SX
8290042
8290044 Silk

Ang. DX
8290041
8290043 Silk

Cottage

LE PIETRE

TAUPE

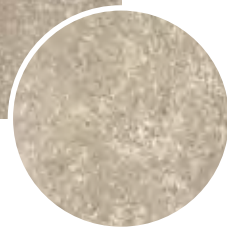

20 MM

GRIP RETT

60x120 24"x47"
8290031

60x60 24"x24"
8290030

9 MM

RETT

90x90 36"x36"
8290034
8290134 Silk

45x90 18"x36"
8290035
8290135 Silk

9 MM

RETT

60x120 24"x47"
8290039
8290139 Silk

60x60 24"x24"
8290038
8290138 Silk

30x60 12"x24"
8290037
8290137 Silk

GRIP RETT

60x120 24"x47"
8200278

60x60 24"x24"
8200297

30x60 12"x24"
8200308

NON RETT

30x60 12"x24"
7290037

GRIP NON RETT

30x60 12"x24"
7290038



Battiscopa
RETT
7,5x60 3"x24"
8290131

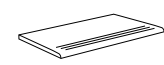

Step
RETT
30x60 12"x24"
8290032

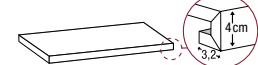

Gradone costa retta
RETT
33,3x120x4
13"x47"x1,57"
8290070
8290075 Silk

Ang. SX
8290072
8290074 Silk

Ang. DX
8290071
8290073 Silk

MUD

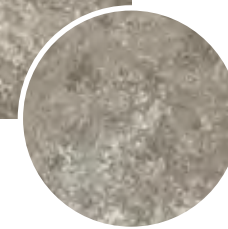

20 MM

GRIP RETT

60x120 24"x47"
8290011

60x60 24"x24"
8290010

9 MM

RETT

90x90 36"x36"
8290014
8290114 Silk

45x90 18"x36"
8290015
8290115 Silk

9 MM

RETT

60x120 24"x47"
8290019
8290119 Silk

60x60 24"x24"
8290018
8290118 Silk

30x60 12"x24"
8290017
8290117 Silk

GRIP RETT

60x120 24"x47"
8200277

60x60 24"x24"
8200296

30x60 12"x24"
8200304

NON RETT

30x60 12"x24"
7290017

GRIP NON RETT

30x60 12"x24"
7290018



Battiscopa
RETT
7,5x60 3"x24"
8290111

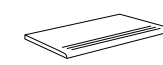

Step
RETT
30x60 12"x24"
8290012

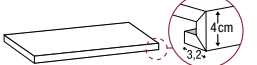

Gradone costa retta
RETT
33,3x120x4
13"x47"x1,57"
8290060
8290065 Silk

Ang. SX
8290062
8290064 Silk

Ang. DX
8290061
8290063 Silk

Cottage

COMPOSIZIONE MODULO

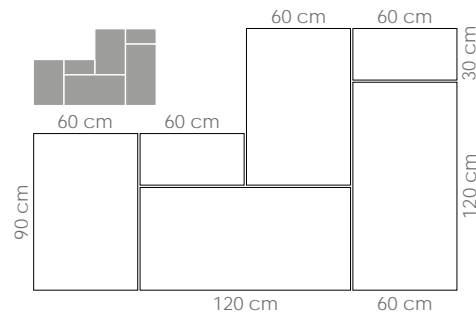
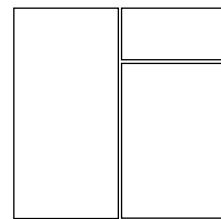

Soluzione 1

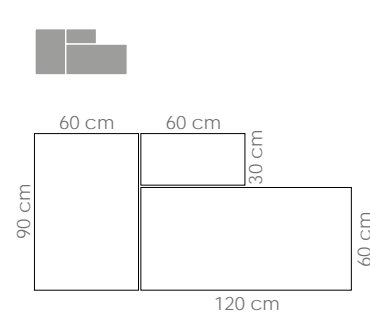

Soluzione 2

9 MM

RETT

60x120 24"x47"
60x90 24"x36"
30x60 12"x24"

RETT

60x120 24"x47"
60x90 24"x36"
30x60 12"x24"

Milk 8290003
Honey 8290023
Taupe 8290033
Mud 8290013

Milk 8290103 Silk
Honey 8290123 Silk
Taupe 8290133 Silk
Mud 8290113 Silk

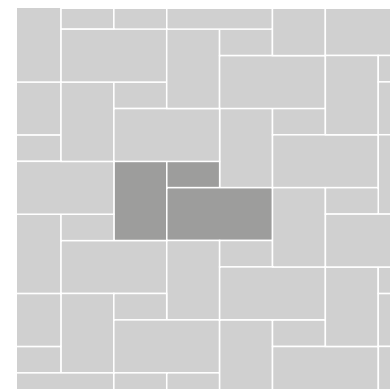
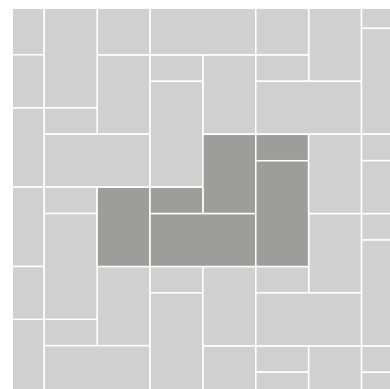

COTTAGE

Mud composizione modulo soluzione 2 cm 60x120 24"x47", cm 60x90 24"x36", cm 30x60 12"x24" Rett



LE PIETRE

COTTAGE

Indoor: Taupe composizione modulo soluzione 1 cm 60x120 24"x47", cm 60x90 24"x36", cm 30x60 12"x24" Rett
Outdoor: Taupe cm 60x60x2 24"x24"x0,7" Rett Grip

Hills



HILLS
Cerreto

Gres Porcellanato

Porcelained stoneware
Grès cérame
Feinsteinzeug

Spessore / Thickness



9 MM

Finiture / Finishes

RT / Rettificato
RT ROC / Rettificato ROC

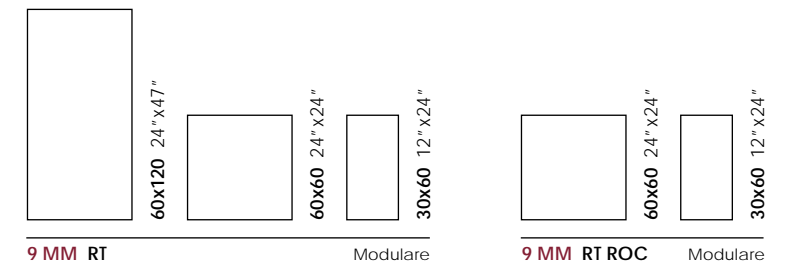

Bia



V4



fuga
2MM
Rett



R11
ROC



A+B+C
ROC

Bia GL

CE

Packaging pag. 312

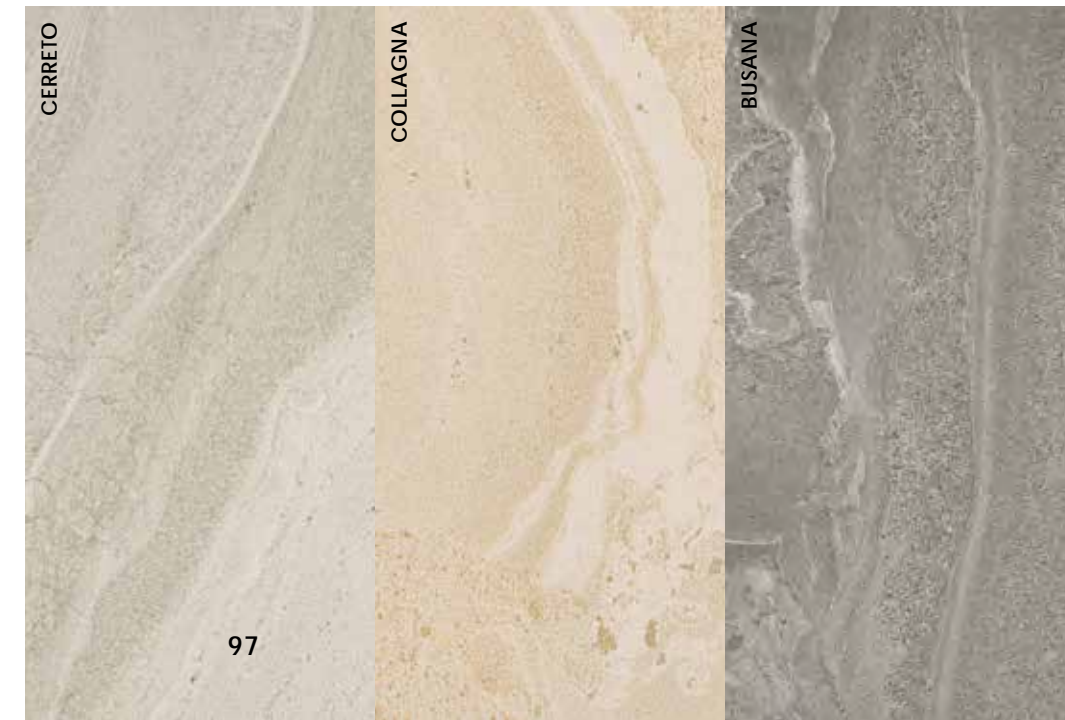

CERRETO

COLLAGNA

BUSANA



HILLS
Busana 60x60 24"x24" Rett RoC



HILLS
Cerreto 30x60 12"x24" Rett Roc, 30x60 12"x24" Rett

CERRETO



9 MM

RETT

60x120 24"x47"
8228174

60x60 24"x24"
8228175

30x60 12"x24"
8228176

ROC RETT

60x60 24"x24"
8200450

30x60 12"x24"
8200452



9 MM

Mosaico NON RETT
30x30 12"x12"
7276655



Battiscopa
RETT
7,5x60 3"x24"
8228177

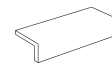

Elemento ad L
ROC NON RETT
4x15x30 1,57"x6"x12"
7329549

BUSANA

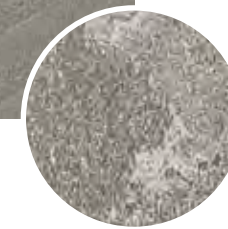

9 MM

RETT

60x120 24"x47"
8228154

60x60 24"x24"
8228155

30x60 12"x24"
8228156

ROC RETT

60x60 24"x24"
8200440

30x60 12"x24"
8200442



9 MM

Mosaico NON RETT
30x30 12"x12"
7276685



Battiscopa
RETT
7,5x60 3"x24"
8228157

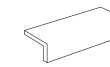

Elemento ad L
ROC NON RETT
4x15x30 1,57"x6"x12"
7329539

Hills

COLLAGNA

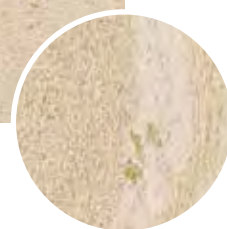

9 MM

RETT

60x120 24"x47"
8228164

60x60 24"x24"
8228165

30x60 12"x24"
8228166

ROC RETT

60x60 24"x24"
8200460

30x60 12"x24"
8200462



9 MM

Mosaico NON RETT
30x30 12"x12"
7276665



Battiscopa
RETT
7,5x60 3"x24"
8228167

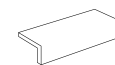

Elemento ad L
ROC NON RETT
4x15x30 1,57"x6"x12"
7329559



Lathemar

Gres Porcellanato

Porcelained stoneware
Grès cérame
Feinsteinzeug

Spessore / Thickness



8 MM

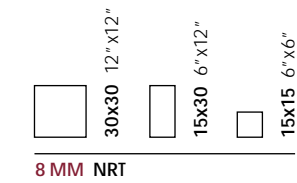

Finiture / Finishes

NRT / Non Rettificato

È sempre consigliabile posare i formati 30x30 e/o 15x15 all'interno dell'elemento a "L" con una posa in diagonale

It is always advisable to lay 30x30 size tiles and/or 15x15 size tiles crosswise within the "L" element
Il est toujours conseillé de poser les formats 30x30 et/ou 15x15 à l'intérieur de l'élément en "L" avec une pose en diagonale
Das verlegen der formate 30x30 und/oder 15x15 sollte stets im innern des I-förmigen elements erfolgen. Dabei diagonal vorgehen



Bla



V3



fuga
> 3MM
Non Rett



Bia GL

CE

Packaging pag. 312

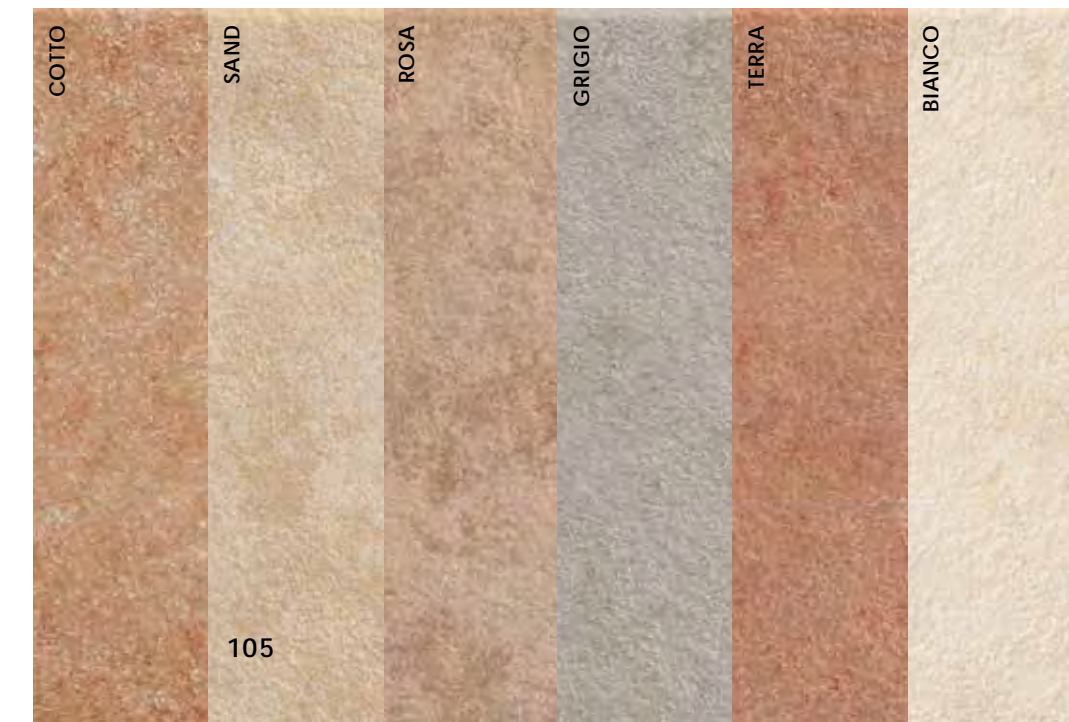



LATHEMAR
Cotto 15x30 6" x12" Non Rett

Lathemar

LE PIETRE

COTTO



8 MM

NON RETT

30x30 12"x12"
7265282

15x30 6"x12"
7002003

15x15 6"x6"
7001293



Battiscopa
NON RETT
7,5x30 3"x12"
7703061

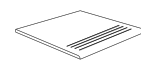

Step
NON RETT
30x30 12"x12"
7262380

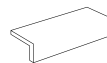

Elemento ad L
NON RETT
4x15x30 1,57"x6"x12"
7158769

ROSA



8 MM

NON RETT

30x30 12"x12"
7265242

15x30 6"x12"
7002012

15x15 6"x6"
7001312



Battiscopa
NON RETT
7,5x30 3"x12"
7703180

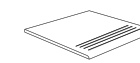

Step
NON RETT
30x30 12"x12"
7265671

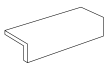

Elemento ad L
NON RETT
4x15x30 1,57"x6"x12"
7158779

SAND



8 MM

NON RETT

30x30 12"x12"
7265232

15x30 6"x12"
7002022

15x15 6"x6"
7001302



Battiscopa
NON RETT
7,5x30 3"x12"
7703170

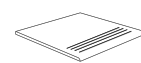

Step
NON RETT
30x30 12"x12"
7265660



Elemento ad L
NON RETT
4x15x30 1,57"x6"x12"
7158819

GRIGIO



8 MM

NON RETT

30x30 12"x12"
7265252

15x30 6"x12"
7002032

15x15 6"x6"
7001322



Battiscopa
NON RETT
7,5x30 3"x12"
7703030

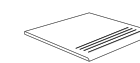

Step
NON RETT
30x30 12"x12"
7265681



Elemento ad L
NON RETT
4x15x30 1,57"x6"x12"
7158839

Lathemar

TERRA



8 MM

NON RETT

30x30 12"x12"
7158682

15x30 6"x12"
7002004

15x15 6"x6"
7001294



Battiscopa
NON RETT
7,5x30 3"x12"
7703171

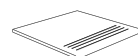

Step
NON RETT
30x30 12"x12"
7265652



Elemento ad L
NON RETT
4x15x30 1,57"x6"x12"
7158818

BIANCO



8 MM

NON RETT

30x30 12"x12"
7265223

15x15 6"x6"
7001342



Battiscopa
NON RETT
7,5x30 3"x12"
7703000

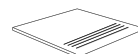

Step
NON RETT
30x30 12"x12"
7265650



Elemento ad L
NON RETT
4x15x30 1,57"x6"x12"
7158829



Neutra Roc



Gres Porcellanato

Porcelained stoneware
Grès cérame
Feinsteinzeug

Spessore / Thickness



20 MM

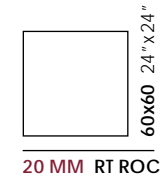

Finiture / Finishes

RT ROC / Rettificato ROC

Su richiesta / On demand

Pezzi speciali 20MM /
Trims 20MM

pag. 338



Bla



V2



fuga
2MM
Rett



R11
ROC



A+B+C
ROC

Bia GL

CE

Packaging pag. 312

NEUTRA ROC
Avorio



Neutra Roc

AVORIO



20 MM

RETT ROC

60x60 24"x24"
8685887

BEIGE



20 MM

RETT ROC

60x60 24"x24"
8685909

PIOMBO

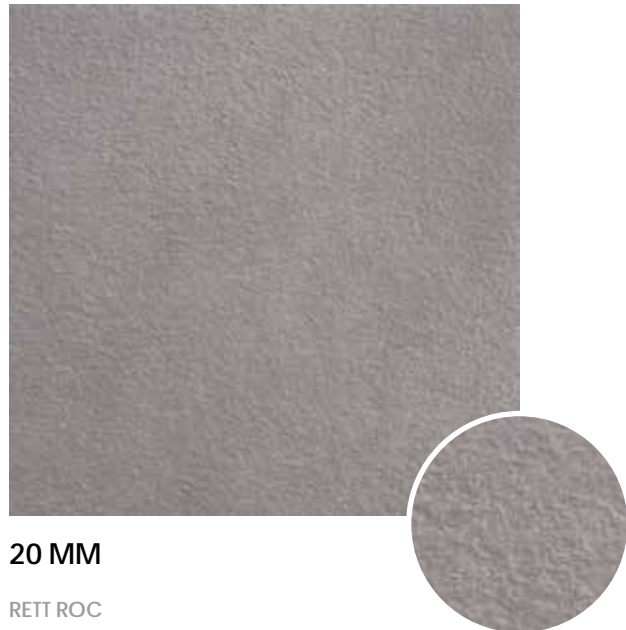

20 MM

RETT ROC

60x60 24"x24"
8685919

NERO



20 MM

RETT ROC

60x60 24"x24"
8685929



LE PIETRE

NEUTRA ROC
Beige 60x60 24" x24" Rett Roc

Pangea



PANGEA
Cenere

Gres Porcellanato

Porcelained stoneware
Grès cérame
Feinsteinzeug

Spessore / Thickness



20 MM
9 MM

Finiture / Finishes

RT / Rettificato
NRT / Non rettificato
RT GR / Rettificato Grip
NRT ROC / Non rettificato ROC

Su richiesta / On demand

Pezzi speciali 20MM /
Trims 20MM

pag. 338



Bla



V3



fuga
2MM
Rett



fuga
> 3MM
Non Rett



R11
GRIP
ROC



A+B+C
GRIP
ROC

Bia GL

CE

Packaging pag. 313

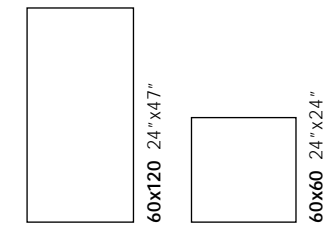

20 MM RT GR Modulare
Only: Beige, Cenere, Grigio

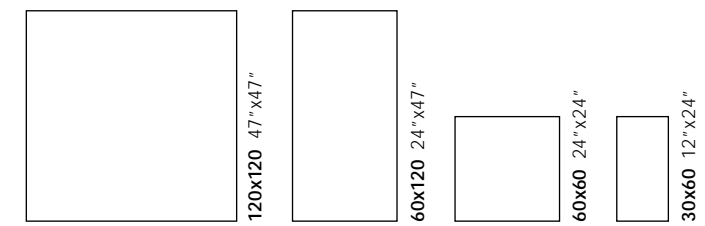

9 MM RT / RT GR Modulare
Grip Rett only 60x120 - 60x60 - 30x60

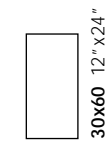

9 MM NRT

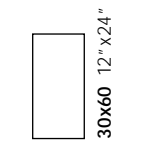

9 MM NRT ROC

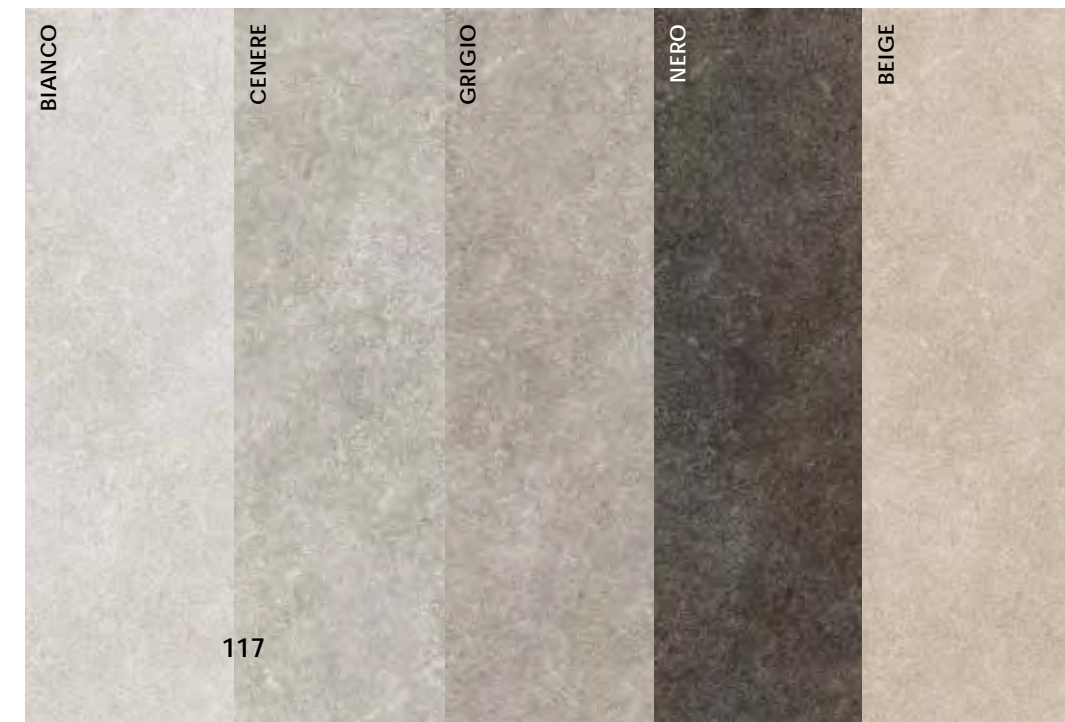



Indoor: PANGEA Cenere 60x60 24"x24" Rett - MARVILLA Bernini 90x270 36"x106" Rett Lucido
Outdoor: PANGEA Cenere 60x60 24"x24" Rett Grip



PANGEA Cenere Losanga 36,1x57,6 14,21"x22,67" Rett
VENEXIA Giudecca 90x90 36"x36" Rett



Indoor: PANGEA Beige 120x120 47"x47" Rett - PASTELLI Opale 90x270 36"x106" Rett Matt
Outdoor: PANGEA Beige 60x120 24"x47" Rett Grip



PANGEA Beige Esagoni 27,4x31,7 10,78"x12,48" Rett
ARBOR Gelso 20x120 8"x47" Rett



Wall: PANGEA Grigio 60x120 24"x47" Rett
Floor: PANGEA Grigio 60x120x2 24"x47"x0,7" Rett Grip

Pangea

BIANCO



9 MM

RETT

120x120 47"x47"
8200507

60x120 24"x47"
8200526

60x60 24"x24"
8200637

30x60 12"x24"
8200636

NON RETT

30x60 12"x24"
7200034

GRIP RETT

60x120 24"x47"
8200715

60x60 24"x24"
8200716

30x60 12"x24"
8200714

ROC NON RETT

30x60 12"x24"
7200033



Battiscopa
RETT
7,5x60 3"x24"
8200689

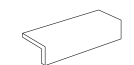

Elemento ad L
ROC
4x15x30 1,57"x6"x12
7200057

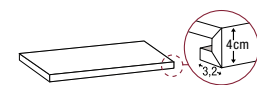

Gradone costa retta
Angolare DX/SX
RETT
33,3x120x4 13"x47"x1,57"
SU RICHIESTA. ON DEMAND.
SUR DEMANDE. AUF ANFRAGE



Esagoni NON RETT
27,4x31,7 10,78"x12,48"
8200668



Losanga NON RETT
36,1x57,6 14,21"x22,67"
8200317

CENERE



20 MM

GRIP RETT

60x120 24"x47"
8232003

60x60 24"x24"
8232004

9 MM

RETT

120x120 47"x47"
8200508

60x120 24"x47"
8200527

60x60 24"x24"
8200639

30x60 12"x24"
8200638

NON RETT

30x60 12"x24"
7200037

GRIP RETT

60x120 24"x47"
8200718

60x60 24"x24"
8200719

30x60 12"x24"
8200717

ROC NON RETT

30x60 12"x24"
7200036



Battiscopa
RETT
7,5x60 3"x24"
8200798



Elemento ad L
ROC
4x15x30 1,57"x6"x12
7200058

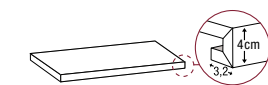

Gradone costa retta
Angolare DX/SX
RETT
33,3x120x4 13"x47"x1,57"
SU RICHIESTA. ON DEMAND.
SUR DEMANDE. AUF ANFRAGE



Esagoni NON RETT
27,4x31,7 10,78"x12,48"
8200669



Losanga NON RETT
36,1x57,6 14,21"x22,67"
8200318

Pangea

GRIGIO



20 MM

GRIP RETT

60x120 24"x47"
8232005

60x60 24"x24"
8232006

9 MM

RETT

120x120 47"x47"
8200509

60x120 24"x47"
8200528

60x60 24"x24"
8200646

30x60 12"x24"
8200645

NON RETT

30x60 12"x24"
7200039

GRIP RETT

60x120 24"x47"
8200723

60x60 24"x24"
8200724

30x60 12"x24"
8200722

ROC NON RETT

30x60 12"x24"
7200038



Esagoni NON RETT
27,4x31,7 10,78"x12,48"
8200727



Losanga NON RETT
36,1x57,6 14,21"x22,67"
8200348



Battiscopa
RETT
7,5x60 3"x24"
8200799

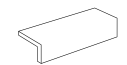

Elemento ad L
ROC
4x15x30 1,57"x6"x12
7200059

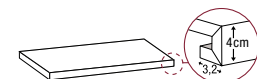

Gradone costa retta
Angolare DX/SX
RETT
33,3x120x4 13"x47"x1,57"
SU RICHIESTA. ON DEMAND.
SUR DEMANDE. AUF ANFRAGE

NERO



9 MM

RETT

120x120 47"x47"
8200513

60x120 24"x47"
8200529

60x60 24"x24"
8200648

30x60 12"x24"
8200647

NON RETT

30x60 12"x24"
7200041

GRIP RETT

60x120 24"x47"
8200726

60x60 24"x24"
8200728

30x60 12"x24"
8200725

ROC NON RETT

30x60 12"x24"
7200040



Esagoni NON RETT
27,4x31,7 10,78"x12,48"
8200729



Losanga NON RETT
36,1x57,6 14,21"x22,67"
8200359



Battiscopa
RETT
7,5x60 3"x24"
8200809

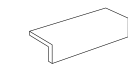

Elemento ad L
ROC
4x15x30 1,57"x6"x12
7200060

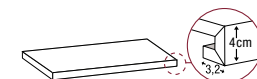

Gradone costa retta
Angolare DX/SX
RETT
33,3x120x4 13"x47"x1,57"
SU RICHIESTA. ON DEMAND.
SUR DEMANDE. AUF ANFRAGE

Pangea

BEIGE



20 MM

GRIP RETT

60x120 24"x47"
8232007

60x60 24"x24"
8232008

9 MM

RETT

120x120 47"x47"
8200504

60x120 24"x47"
8200524

60x60 24"x24"
8200628

30x60 12"x24"
8200629

NON RETT

30x60 12"x24"
7200031

GRIP RETT

60x120 24"x47"
8200712

60x60 24"x24"
8200713

30x60 12"x24"
8200709

ROC NON RETT

30x60 12"x24"
7200030



Battiscopa
RETT
7,5x60 3"x24"
8200688

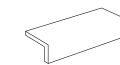

Elemento ad L
ROC
4x15x30 1,57"x6"x12"
7200056

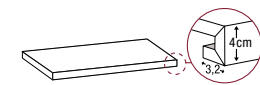

Gradone costa retta
Angolare DX/SX
RETT
33,3x120x4 13"x47"x1,57"
SU RICHIESTA. ON DEMAND.
SUR DEMANDE. AUF ANFRAGE



9 MM

Esagoni NON RETT
27,4x31,7 10,78"x12,48"
8200667



9 MM

Losanga NON RETT
36,1x57,6 14,21"x22,67"
8200313

DECORO TIARÈ



Decoro Tiarè RETT
90x270 36"x106"
T202510 Matt

Coordinato con tutti i colori
Matching with all colours



PANGEA
Bianco 60x120 24"x47" Rett
Decoro Tiarè 90x270 36"x106" Rett

Pietre Pure

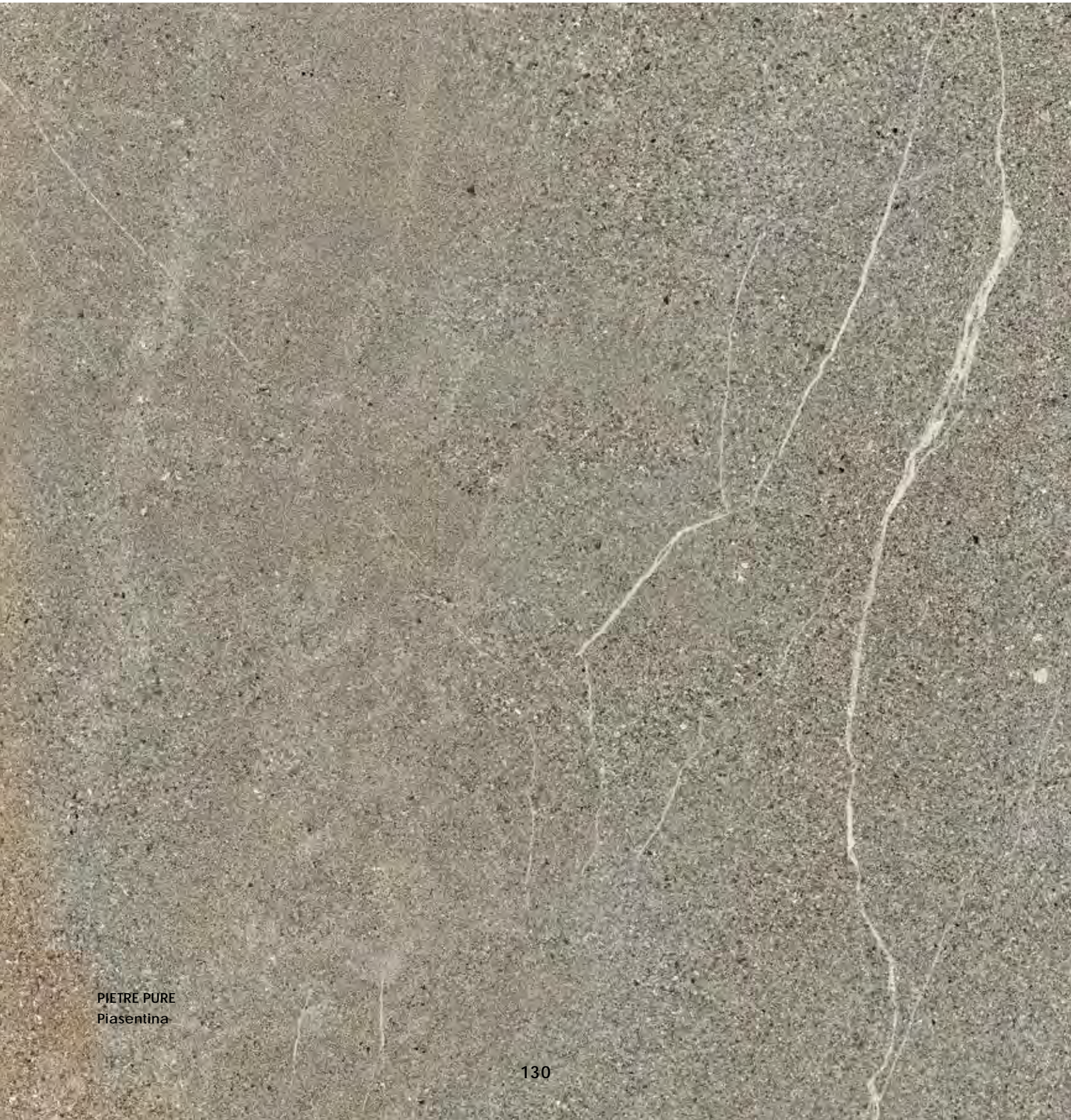

PIETRE PURE
Piasentina

Gres Porcellanato

Porcelained stoneware
Grès cérame
Feinsteinzeug

Spessore / Thickness



20 MM
9 MM
8 MM

Finiture / Finishes

RT / Rettificato
NRT / Non rettificato
RT LP / Rettificato Lappato
RT GR / Rettificato Grip
RT ROC / Rettificato ROC
NRT ROC / Non rettificato ROC

Su richiesta / On demand

Pezzi speciali 20 MM /
Trims 20 MM

pag. 338



Bla



V4



fuga
2MM
Rett



fuga
> 3MM
Non Rett



R11
GRIP
ROC



A+B+C
GRIP
ROC

Bla GL

CE

Packaging pag. 313

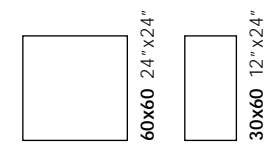
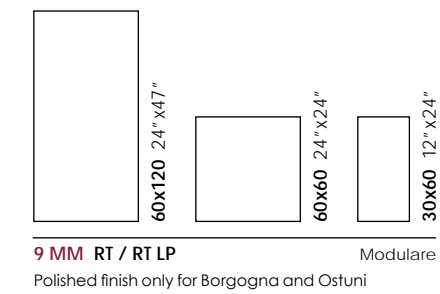
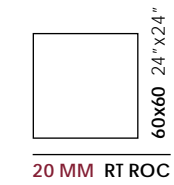

Modulare

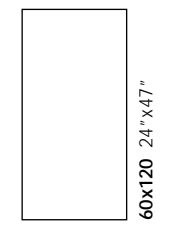

Only: Bagnolo, Borgogna, Ostuni

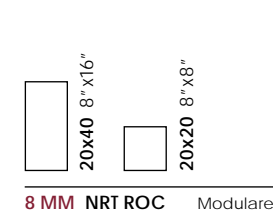
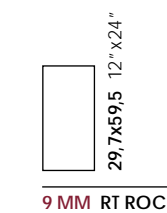
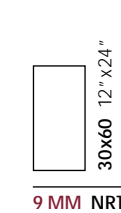

Modulare

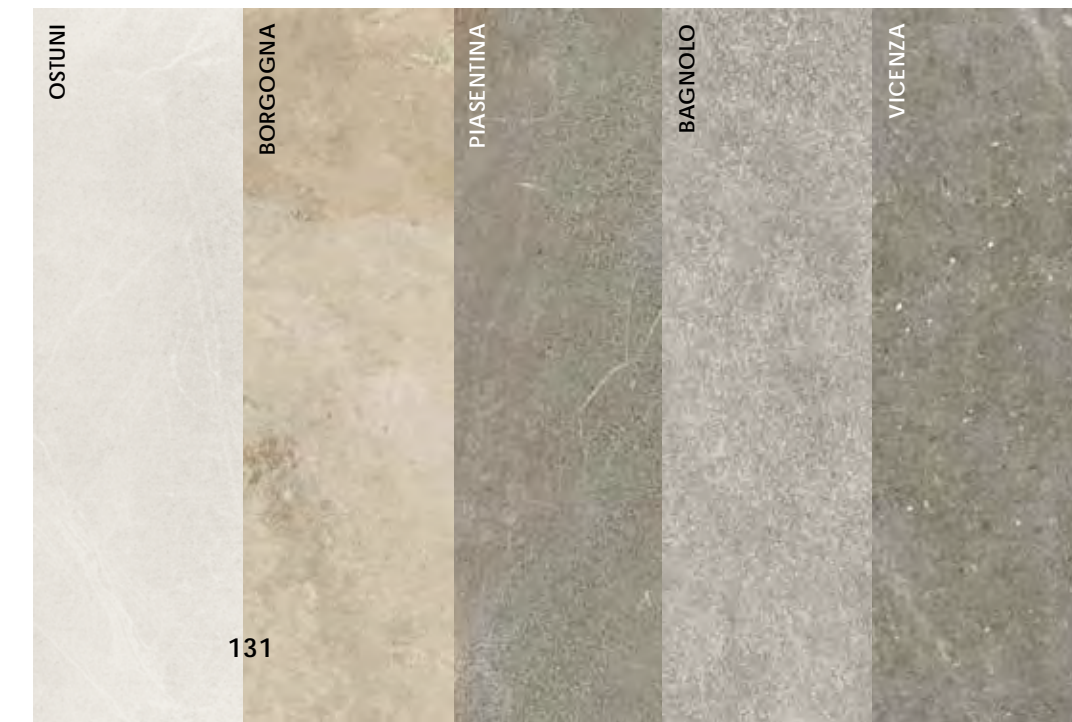



PIETRE PURE
Ostuni 30x60 12"x24" Roc



PIETRE PURE
Piasentina 20x20 8"x8", 20x40 8"x16" Rett Roc



PIETRE PURE
Borgogna 60x60x2 24"x24"x0,7" Rett Roc

Pietre Pure

OSTUNI



20 MM

ROC RETT

60x60 24"x24"
8232355

9 MM

RETT

60x120 24"x47"
8331795
8331845 Lappato

60x60 24"x24"
8331935
8331945 Lappato

30x60 12"x24"
8280111
8280121 Lappato

GRIP RETT

60x120 24"x47"
8331347

ROC RETT

29,7x59,5 12"x24"
7280065

NON RETT

30x60 12"x24"
7280102

ROC NON RETT

30x60 12"x24"
7279985



Battiscopa
RETT
7,5x60 3"x24"
8331936

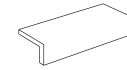

Elemento ad L
ROC NON RETT
4x15x30 1,57"x6"x12"
7280206

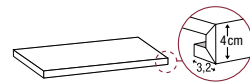

Gradone costa retta
RETT
33,3x120x4
13"x47"x1,57"
7331799

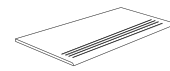

Step
RETT
30x60 12"x24"
8280113

Angolare
DX 7331797
SX 7331798



Mosaico NON RETT
30x30 12"x12"
7280335



Listellato NON RETT
30x60 12"x24"
7280395

BORGOGNA

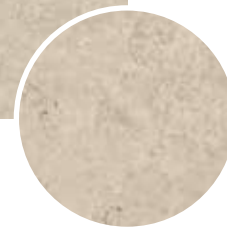

20 MM

ROC RETT

60x60 24"x24"
8232315

9 MM

RETT

60x120 24"x47"
8331805
8331855 Lappato

60x60 24"x24"
8331965
8331975 Lappato

30x60 12"x24"
8280141
8280151 Lappato

GRIP RETT

60x120 24"x47"
8331667

ROC RETT

29,7x59,5 12"x24"
7280055

NON RETT

30x60 12"x24"
7280131

ROC NON RETT

30x60 12"x24"
7279975



Battiscopa
RETT
7,5x60 3"x24"
8331966

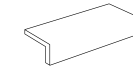

Elemento ad L
ROC NON RETT
4x15x30 1,57"x6"x12"
7280205

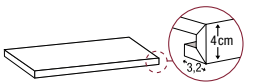

Gradone costa retta
RETT
33,3x120x4
13"x47"x1,57"
7331809

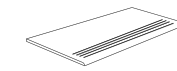

Step
RETT
30x60 12"x24"
8280143

Angolare
DX 7331807
SX 7331808



Mosaico NON RETT
30x30 12"x12"
7280305



Listellato NON RETT
30x60 12"x24"
7280365

Pietre Pure

PIASENTINA



20 MM

ROC RETT

60x60 24"x24"
8232325

9 MM

RETT

60x120 24"x47"
8331815

60x60 24"x24"
8331995

30x60 12"x24"
8280171

ROC RETT

29,7x59,5 12"x24"
7280075

NON RETT

30x60 12"x24"
7280161

ROC NON RETT

30x60 12"x24"
7279995

8 MM

ROC NON RETT

20x40 8"x16"
7278661

20x20 8"x8"
7278621



Battiscopa
RETT
7,5x60 3"x24"
8331996

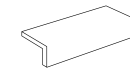

Elemento ad L
ROC NON RETT
4x15x30 1,57"x6"x12"
7280207

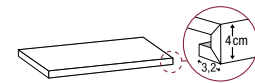

Gradone costa retta
RETT
33,3x120x4
13"x47"x1,57"
7331719

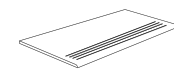

Step
RETT
30x60 12"x24"
8280173

Angolare
DX 7331717
SX 7331718



Mosaico NON RETT
30x30 12"x12"
7280315



Listellato NON RETT
30x60 12"x24"
7280375

BAGNOLO

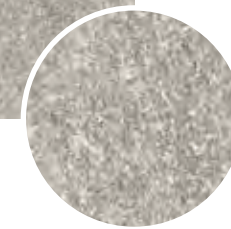

20 MM

ROC RETT

60x60 24"x24"
8232335

9 MM

RETT

60x120 24"x47"
8331785

60x60 24"x24"
8332025

30x60 12"x24"
8280201

GRIP RETT

60x120 24"x47"
8331677

ROC RETT

29,7x59,5 12"x24"
7280045

NON RETT

30x60 12"x24"
7280191

ROC NON RETT

30x60 12"x24"
7279966



Battiscopa
RETT
7,5x60 3"x24"
8332026

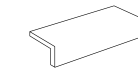

Elemento ad L
ROC NON RETT
4x15x30 1,57"x6"x12"
7280204

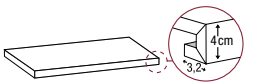

Gradone costa retta
RETT
33,3x120x4
13"x47"x1,57"
7331789

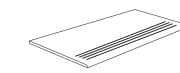

Step
RETT
30x60 12"x24"
8280203

Angolare
DX 7331787
SX 7331788



Mosaico NON RETT
30x30 12"x12"
7280325



Listellato NON RETT
30x60 12"x24"
7280385

Pietre Pure

VICENZA

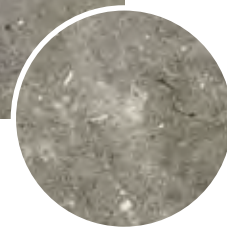

20 MM

ROC RETT

60x60 24"x24"
8232305

9 MM

RETT

60x120 24"x47"
8331825

60x60 24"x24"
8332055

30x60 12"x24"
8280231

ROC RETT

29,7x59,5 12"x24"
7280095

NON RETT

30x60 12"x24"
7280221

ROC NON RETT

30x60 12"x24"
7280016

8 MM

ROC NON RETT

20x40 8"x16"
7278641

20x20 8"x8"
7278601



Battiscopa
RETT
7,5x60 3"x24"
8332056

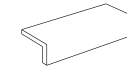

Elemento ad L
ROC NON RETT
4x15x30 1,57"x6"x12"
7280210

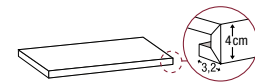

Gradone costa retta
RETT
33,3x120x4
13"x47"x1,57"
7331829

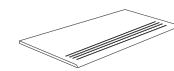

Step
RETT
30x60 12"x24"
8280233

Angolare
DX 7331827
SX 7331828



9 MM

Mosaico NON RETT
30x30 12"x12"
7280295



9 MM

Listellato NON RETT
30x60 12"x24"
7280355



Stonequartz



STONEQUARTZ
Grigio

Gres Porcellanato

Porcelained stoneware
Grès cérame
Feinsteinzeug

Spessore / Thickness



20 MM
9 MM
8 MM

Finiture / Finishes

RT / Rettificato
NRT / Non Rettificato
RT GR / Rettificato Grip
NRT GR / Non Rettificato Grip
SBR GR / Sbrecciato Grip

Su richiesta / On demand

Pezzi speciali 20MM /
Trims 20MM

pag. 338



Bla



V4



fuga
2MM
Rett



fuga
> 3MM
Nat



R11
GRIP



A+B+C
GRIP

Bia GL

CE

Packaging pag. 314

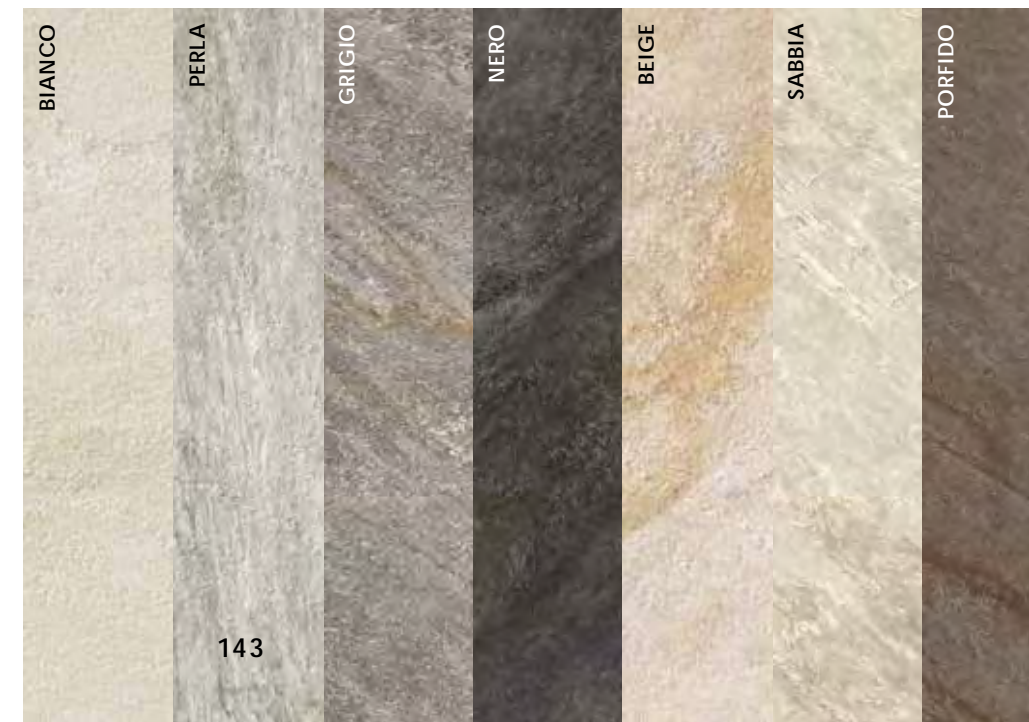



STONEQUARTZ

Indoor: Bianco 60x60 24"x24" Rett

Outdoor: Perla 60x120x2 24"x47"x0,7" Rett Grip



STONEQUARTZ
Nero 45x90 18"x36" Rett



STONEQUARTZ
Grigio 45x90 18"x36" Rett

Stonequartz

LE PIETRE

BIANCO



20 MM	9 MM	8 MM
GRIP RETT	RETT	NON RETT
60x60 24"x24" 8210026	60x120 24"x47" 8200971	30x30 12"x12" 7159001
	60x60 24"x24" 8200970	20x40 8"x16" 7278351
	30x60 12"x24" 8200972	20x20 8"x8" 7278401
	45x90 18"x36" 8249572	15x15 6"x6" 7001382
	GRIP RETT	GRIP NON RETT
	60x120 24"x47" 8200378	15x15 6"x6" 7001412
	60x60 24"x24" 8200379	
	NON RETT	
	30x60 12"x24" 7276905	
	GRIP NON RETT	
	30x60 12"x24" 7277866	

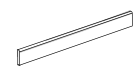

Battiscopa
RETT
7,5x60 3"x24"
8200973

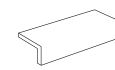

Elemento ad L
NON RETT
4x15x30 1,57"x6"x12"
7277679

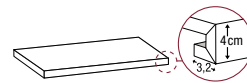

Gradone costa retta
RETT
33,3x120x4
13"x47"x1,57"
7200972

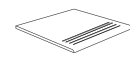

Step
NON RETT
30x30 12"x12"
SU RICHIESTA. ON DEMAND.
SUR DEMANDE. AUF ANFRAGE

Angolare
DX 7200970
SX 7200971



9 MM
Mosaico NON RETT
30x30 12"x12"
7277571



9 MM
Listellato NON RETT
30x60 12"x24"
7277621

PERLA



20 MM	9 MM	8 MM
GRIP RETT	RETT	NON RETT
60x120 24"x47" 7331916	60x120 24"x47" 8201011	30x30 12"x12" 7159011
60x60 24"x24" 8210025	60x60 24"x24" 8201010	20x40 8"x16" 7278361
	30x60 12"x24" 8201012	20x20 8"x8" 7278411
	45x90 18"x36" 8249562	15x15 6"x6" 7001373
	GRIP RETT	GRIP NON RETT
	60x120 24"x47" 8200327	15x15 6"x6" 7001372
	60x60 24"x24" 8200374	
	NON RETT	
	30x60 12"x24" 7276915	
	GRIP NON RETT	
	30x60 12"x24" 7277875	

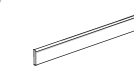

Battiscopa
RETT
7,5x60 3"x24"
8201013

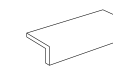

Elemento ad L
NON RETT
4x15x30 1,57"x6"x12"
7277709

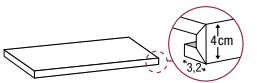

Gradone costa retta
RETT
33,3x120x4
13"x47"x1,57"
7201012

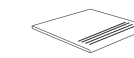

Step
NON RETT
30x30 12"x12"
SU RICHIESTA. ON DEMAND.
SUR DEMANDE. AUF ANFRAGE

Angolare
DX 7201010
SX 7201011

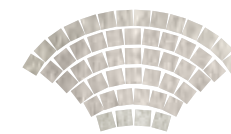

Pavè GRIP NON RETT
53,5x103 21,06"x40,35"
7279041



9 MM
Mosaico NON RETT
30x30 12"x12"
7277601



9 MM
Listellato NON RETT
30x60 12"x24"
7277651

Stonequartz

GRIGIO



20 MM	9 MM	8 MM
GRIP RETT	RETT	NON RETT
60x120 24"x47" 7331906	60x120 24"x47" 8200991	30x30 12"x12" 7159021
60x60 24"x24" 8210015	60x60 24"x24" 8200990	20x40 8"x16" 7278371
	30x60 12"x24" 8200992	20x20 8"x8" 7278421
	45x90 18"x36" 8249582	15x15 6"x6" 7001393
	GRIP RETT	GRIP NON RETT
	60x120 24"x47" 8200287	15x15 6"x6" 7001442
	60x60 24"x24" 8200368	
	NON RETT	
	30x60 12"x24" 7276925	
	GRIP NON RETT	
	30x60 12"x24" 7277885	

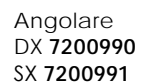
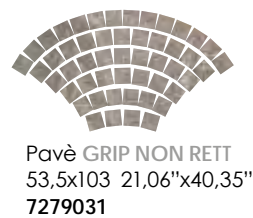

NERO

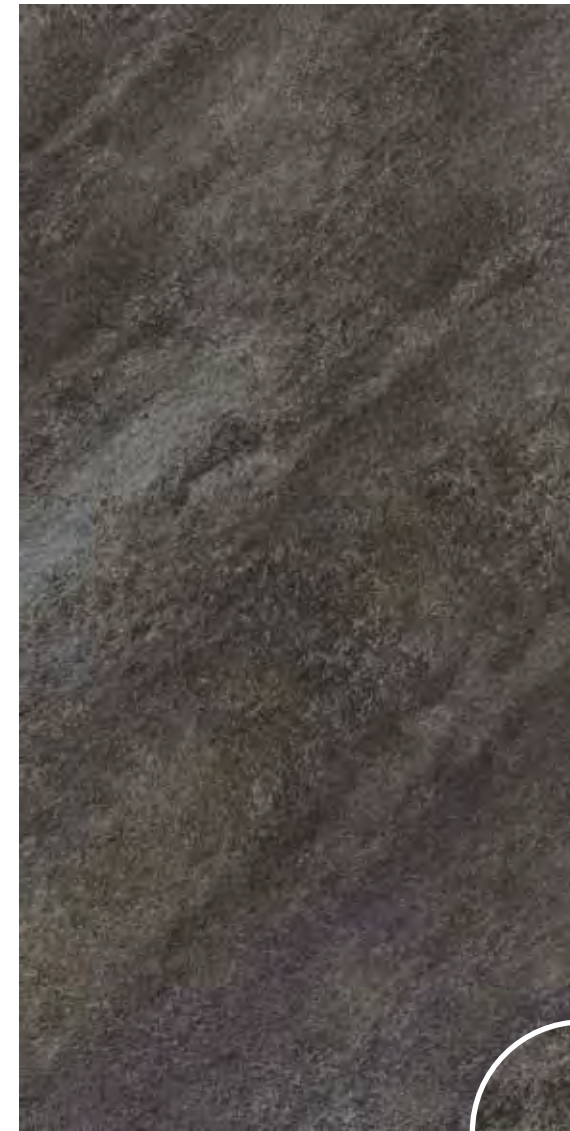

20 MM	9 MM	8 MM
GRIP RETT	RETT	NON RETT
60x60 24"x24" 8210005	60x120 24"x47" 8201001	30x30 12"x12" 7159041
	60x60 24"x24" 8201000	20x40 8"x16" 7278381
	30x60 12"x24" 8201002	20x20 8"x8" 7278431
	45x90 18"x36" 8249592	15x15 6"x6" 7001431
	NON RETT	GRIP NON RETT
	30x60 12"x24" 7276955	15x15 6"x6" 7001432
	GRIP NON RETT	
	30x60 12"x24" 7277905	

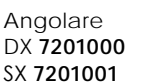
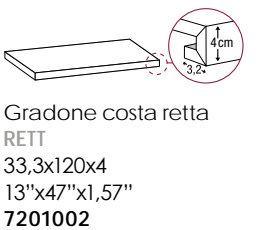

Stonequartz

BEIGE

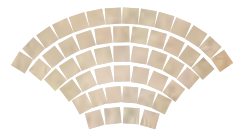

Pavè GRIP NON RETT
53,5x103 21,06"x40,35"
7279021



Mosaico NON RETT
30x30 12"x12"
7277561



Listellato NON RETT
30x60 12"x24"
7277611

20 MM

GRIP RETT

60x120 24"x47"
7331926

60x60 24"x24"
8210024

9 MM

RETT

60x120 24"x47"
8200981

60x60 24"x24"
8200980

30x60 12"x24"
8200982

45x90 18"x36"
8249552

GRIP RETT

60x120 24"x47"
8200307

60x60 24"x24"
8200367

NON RETT

30x60 12"x24"
7276935

GRIP NON RETT

30x60 12"x24"
7277895

8 MM

NON RETT

30x30 12"x12"
7159031

20x40 8"x16"
7278391

20x20 8"x8"
7278441

15x15 6"x6"
7001362

GRIP NON RETT

15x15 6"x6"
7001422



Battiscopa
RETT
7,5x60 3"x24"
8200983

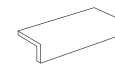

Elemento ad L
NON RETT
4x15x30 1,57"x6"x12"
7277669

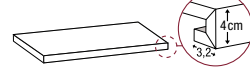

Gradone costa retta
RETT
33,3x120x4
13"x47"x1,57"
7200982

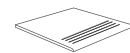

Step
NON RETT
30x30 12"x12"

SU RICHIESTA. ON DEMAND.
SUR DEMANDE. AUF ANFRAGE

Angolare
DX 7200980
SX 7200981

SABBIA

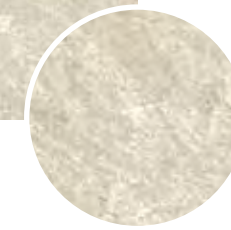

9 MM

NON RETT

30x60 12"x24"
7279055

GRIP NON RETT

30x60 12"x24"
7279155



Battiscopa
NON RETT
7,5x60 3"x24"
7279052

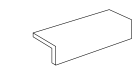

Elemento ad L
NON RETT
4x15x30 1,57"x6"x12"
7279059

PORFIDO

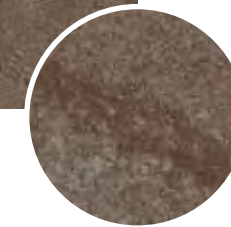

9 MM

NON RETT

30x60 12"x24"
7279065

GRIP NON RETT

30x60 12"x24"
7279165



Battiscopa
NON RETT
7,5x60 3"x24"
7279062

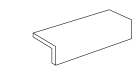

Elemento ad L
NON RETT
4x15x30 1,57"x6"x12"
7279069

Stonequartz

COMPOSIZIONE MODULO

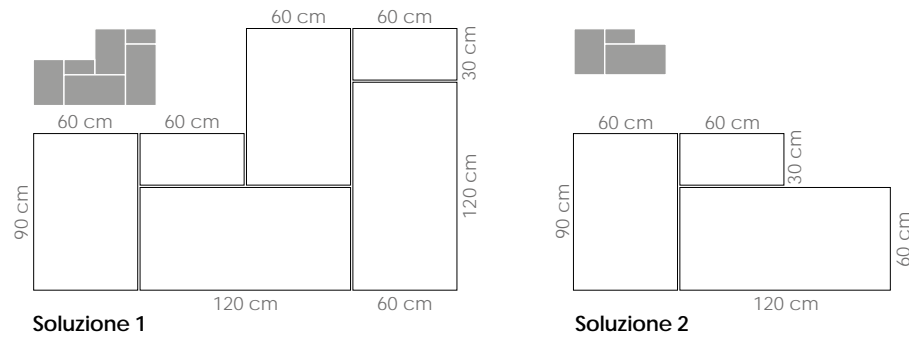
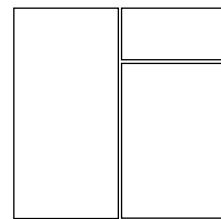

9 MM

RETT

60x120 24"x47"
60x90 24"x36"
30x60 12"x24"

Bianco 8200974
Perla 8201014
Grigio 8200994
Nero 8201004
Beige 8200984

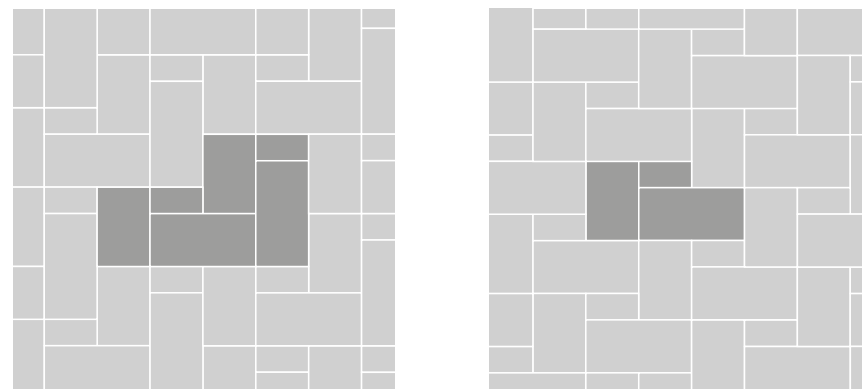

STONEQUARTZ
Perla composizione modulo soluzione 1: 60x120 24"x47", 60x90 24"x36", 30x60 12"x24" Rett

LE PIETRE

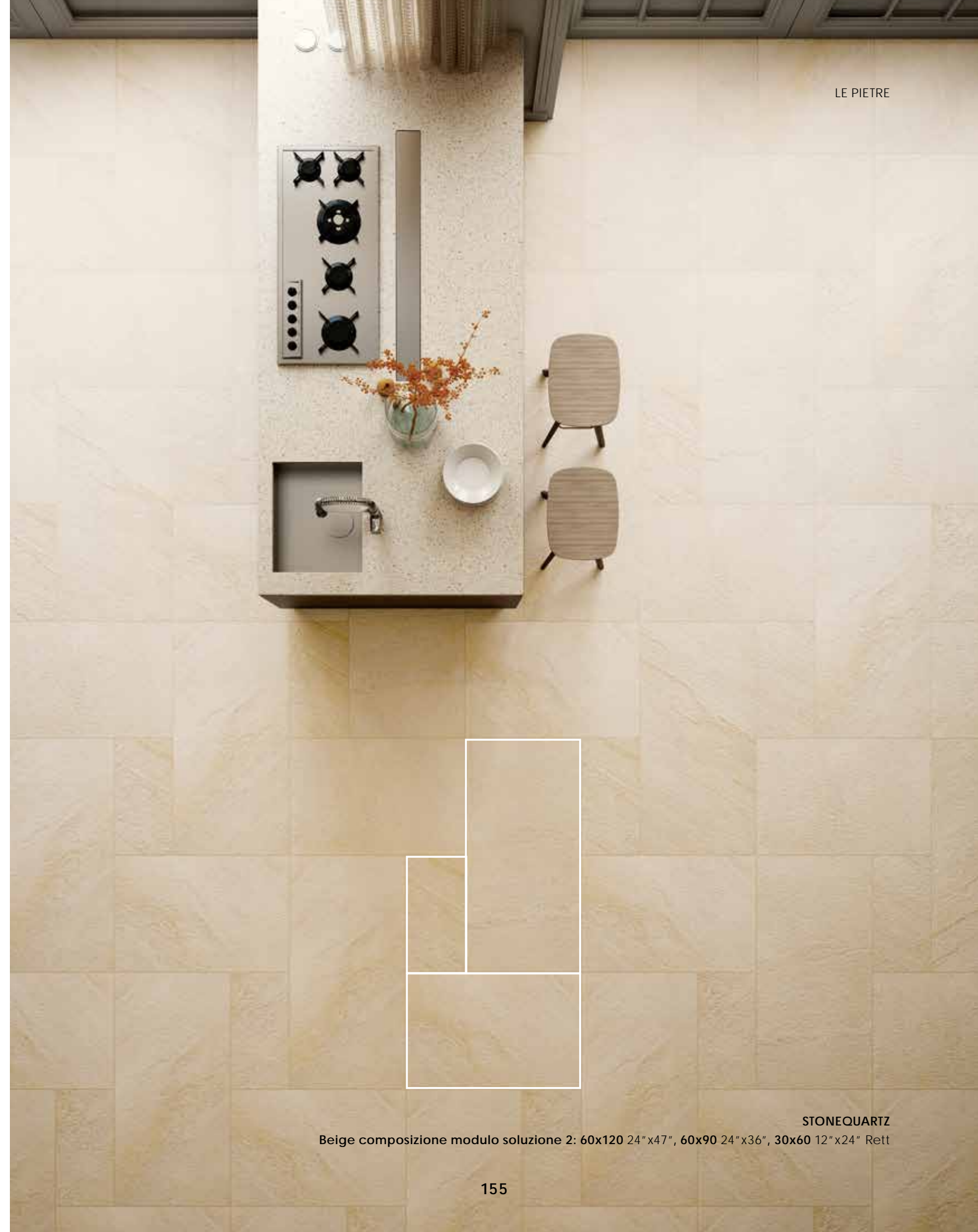

STONEQUARTZ
Beige composizione modulo soluzione 2: 60x120 24"x47", 60x90 24"x36", 30x60 12"x24" Rett

Stonequartz



COMPOSIZIONE MODULO VINTAGE

9 MM

SBRECCIATO GRIP

60x60 24"x24"
40x40 16"x16"
20x40 8"x16"
20x20 8"x8"

Bianco 8200357
Perla 8200354
Grigio 8200349
Beige 8200347

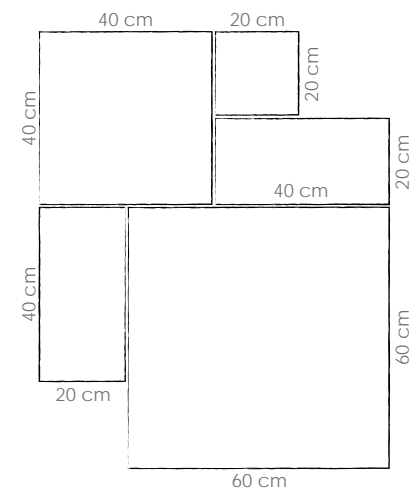

STONEQUARTZ
Grigio composizione modulo vintage:
60x60 24"x24", 40x40 16"x16", 20x40 8"x16", 20x20 8"x8" Sbrecciato Grip



STONEQUARTZ
Grigio composizione modulo vintage: 60x60 24"x24", 40x40 16"x16", 20x40 8"x16", 20x20 8"x8" Sbrecciato Grip



i Marmi

Marble effect
Imitation marbre
Marmor-Optik

Canova 160

Marvilla 180

Palatina 196

Canova



CANOVA
Arni

160

Gres Porcellanato

Porcelained stoneware
Grès cérame
Feinsteinzeug

Spessore / Thickness



12 MM
10 MM
9 MM
6 MM

Finiture / Finishes

RT M / Rettificato Matt
RT LU / Rettificato Lucido
NRT M / Non Rettificato Matt
NRT LU / Non Rettificato Lucido
RT RC / Rettificato ROC

Le grafiche possono presentare delle differenze in base allo spessore del materiale

The patterns may present differences according to the thickness of the material
Les graphiques peuvent présenter des différences selon l'épaisseur du matériau
Die grafiken können unterschiede je nach materialstärke darstellen



Bla



V3

fuga
2MM
RettR11
ROCA+B+C
ROC

Bia GL

CE

Packaging pag. 315

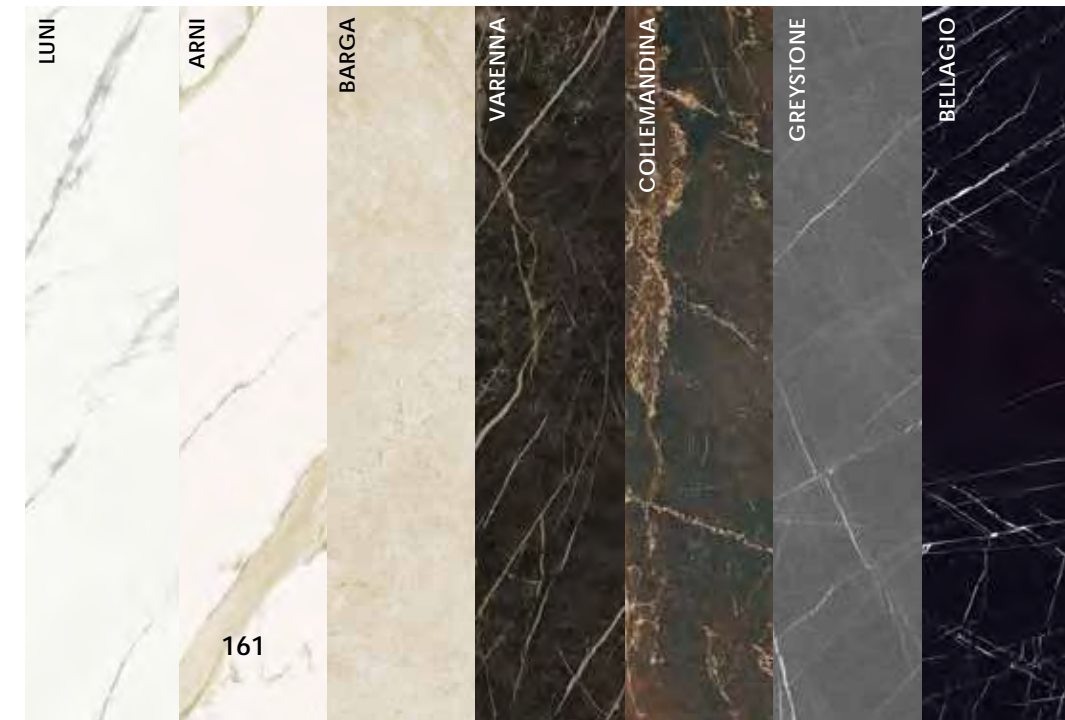
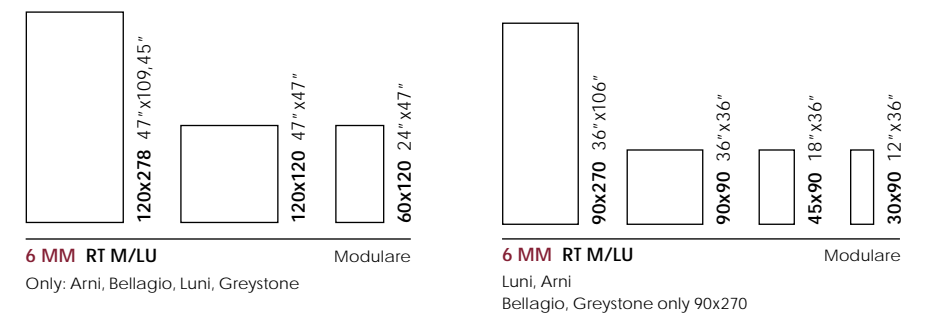
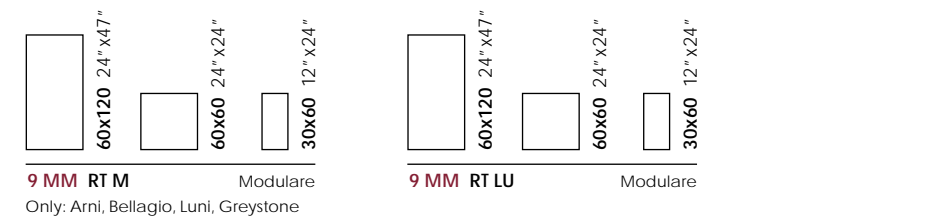
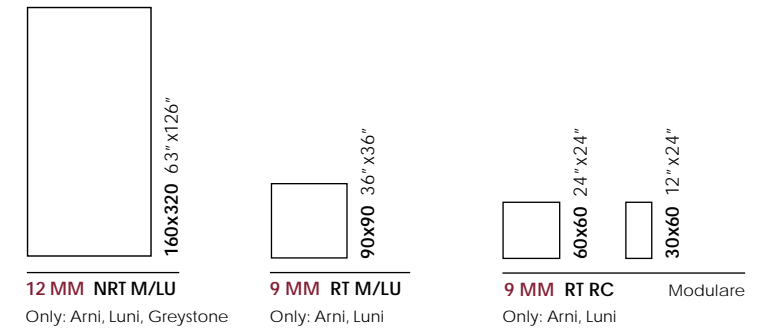

161



CANOVA
 Greystone 120x120 47"x47" Rett Lucido, 120x278 47"x109,45" Rett Matt



CANOVA
 Luni 90x90 36"x36", 90x270 36"x106" Rett Lucido



CANOVA
Varena 60x120 24"x47" Rett Lucido



CANOVA
Barga 60x120 24"x47" Rett Lucido

LUNI



12 MM bookmatch

NON RETT

*160x320 63"x126"
Matt / Lucido

6 MM bookmatch running vein

RETT

**120x278 47"x109,45"
Matt / Lucido

90x270 36"x106"
Matt / Lucido

9 MM

RETT

60x120 24"x47"
8200209 Matt
8200019 Lucido

60x60 24"x24"
8200229 Matt
8200009 Lucido

30x60 12"x24"
8200219 Matt
8200029 Lucido

90x90 36"x36"
8351170 Matt
8351169 Lucido

ROC RETT - R11

60x60 24"x24"
8200038 Roc

30x60 12"x24"
8200037 Roc

6 MM

RETT

120x278 47"x109,45"
T200048 Matt
T200049 Lucido

120x120 47"x47"
T810135 Matt
T810185 Lucido

60x120 24"x47"
T820305 Matt
T820365 Lucido

90x270 36"x106"
T202185 Matt
T202225 Lucido

90x90 36"x36"
T202345 Matt
T202465 Lucido

45x90 18"x36"
T202265 Matt
T202385 Lucido

30x90 12"x36"
T202305 Matt
T202425 Lucido

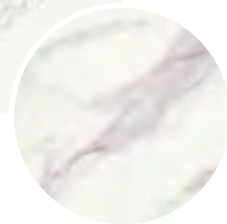

Battiscopa
RETT
7,5x60 3"x24"
8204229 Matt
8200409 Lucido

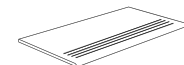

Step
ROC RETT
30x60 12"x24"
8200036

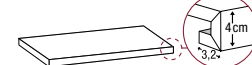

Gradone costa retta
RETT
33,3x120x4
13"x47"x1,57"
7350920 Matt
7350930 Lucido

Ang. SX
7350922 Matt
7350932 Lucido

Ang. DX
7350921 Matt
7350931 Lucido

* Specifiche a pag. 167
* Technical specifications pag. 167

** Specifiche a pag. 168
** Technical specifications pag. 168



9 MM
Mosaico NON RETT
30x30 12"x12"
7350975 Matt
7350985 Lucido

LUNI BOOKMATCH 160x320



A1

A2

12 MM

NON RETT

160x320 63"x126"
Luni A1 **T617006** Matt
Luni A2 **T617007** Matt

160x320 63"x126"
Luni A1 **T617026** Lucido
Luni A2 **T617027** Lucido

Le due facce A1 e A2 di 160x320 devono essere necessariamente acquistate insieme. Immagini puramente indicative: potrebbe presentarsi una discontinuità di vena da una lastra e l'altra. L'eventuale differenza tra una lastra e l'altra fino a 2 cm sono perciò da considerarsi caratteristica del prodotto stesso.

* Stuoia in fibra di vetro nel retropiastrella disponibile a richiesta.

The two faces A1 and A2 in 160x320 cm (63"x126") are only sold together in bundle. Images are purely indicative: a light vein discontinuity from one slab to the next can occur. Therefore differences up to 2 Cm from one slab to the next are admitted and considered a characteristic of the product itself.

* fiber glass back available on demand

Les deux plaques: A1 et A2 du 160x320 doivent être obligatoirement achetées ensemble. Images purement indicatives: une discontinuité niveau veines d'une lame à l'autre parfois pourrait se présenter. L'éventuelle différence entre lames de 2 cm doit être considérées une caractéristique du produit en soi.

Die platten A1 und A2 in 160x320 werden nur in kombination verkauft. Die bilder stellen nur eine richtlinie dar. Es kann vorkommen, dass die aderung von einer platte zu der anderer nicht ganz genau weiterlaeuft und eine toleranz von bis zu 2 Cm ist als eigenschaft des produktes zu betrachten.

LUNI BOOKMATCH 120x278



F

B

6 MM

RETT

120x278 47"x109,45"
Luni F **T200061** Matt
Luni B **T200060** Matt

120x278 47"x109,45"
Luni F **T200059** Lucido
Luni B **T200058** Lucido

Immagini puramente indicative:
potrebbe presentarsi una discontinuità di vena da una Lastra e l'altra. L'eventuale differenza tra una lastra e l'altra fino a 2 cm sono perciò da considerarsi caratteristica del prodotto stesso.

Images are purely indicative:
a light vein discontinuity from one slab to the next can occur. Therefore differences up to 2 Cm from one slab to the next are admitted and considered a characteristic of the product itself.

Images purement indicatives:
une discontinuité niveau veines d'une lame à l'autre parfois pourrait se présenter. L'éventuelle différence entre lames de 2 cm doit être considérées une caractéristique du produit en soi.

Die bilder stellen nur eine richtlinie dar.
Es kann Vorkommen, dass die aderung von einer platte Zu der anderer nicht ganz genau weiterlaeuft Und Eine toleranz von bis zu 2 Cm ist als eigenschaft Des produktes zu betrachten.

LUNI RUNNING VEIN 90x270



A

B

C

D

E

6 MM

RETT

90x270 36"x106"
Luni A **T222536** Matt
Luni B **T222537** Matt
Luni C **T222538** Matt
Luni D **T222539** Matt
Luni E **T222540** Matt

90x270 36"x106"
Luni A **T202226** Lucido
Luni B **T202227** Lucido
Luni C **T202228** Lucido
Luni D **T202229** Lucido
Luni E **T202230** Lucido

Immagini puramente indicative:
potrebbe presentarsi una discontinuità di vena da una Lastra e l'altra. L'eventuale differenza tra una lastra e l'altra fino a 2 cm sono perciò da considerarsi caratteristica del prodotto stesso.

Images are purely indicative:
a light vein discontinuity from one slab to the next can occur. Therefore differences up to 2 Cm from one slab to the next are admitted and considered a characteristic of the product itself.

Images purement indicatives:
une discontinuité niveau veines d'une lame à l'autre parfois pourrait se présenter. L'éventuelle différence entre lames de 2 cm doit être considérées une caractéristique du produit en soi.

Die bilder stellen nur eine richtlinie dar.
Es kann Vorkommen, dass die aderung von einer platte Zu der anderer nicht ganz genau weiterlaeuft Und Eine toleranz von bis zu 2 Cm ist als eigenschaft Des produktes zu betrachten.

ARNI



12 MM bookmatch

NON RETT

*160x320 63"x126"
Matt / Lucido

6 MM bookmatch running vein

RETT

**120x278 47"x109,45"
Matt / Lucido

90x270 36"x106"
Matt / Lucido

9 MM

RETT

60x120 24"x47"
8200069 Matt
8200039 Lucido

60x60 24"x24"
8200089 Matt
8200059 Lucido

30x60 12"x24"
8200079 Matt
8200049 Lucido

90x90 36"x36"
8351130 Matt
8351129 Lucido

ROC RETT - R11

60x60 24"x24"
8200028 Roc

30x60 12"x24"
8200027 Roc

6 MM

RETT

120x278 47"x109,45"
T200044 Matt
T200047 Lucido

120x120 47"x47"
T810115 Matt
T810165 Lucido

60x120 24"x47"
T820335 Matt
T820395 Lucido

90x270 36"x106"
T202195 Matt
T202235 Lucido

90x90 36"x36"
T202355 Matt
T202475 Lucido

45x90 18"x36"
T202275 Matt
T202395 Lucido

30x90 12"x36"
T202315 Matt
T202435 Lucido

* Specifiche a pag. 171
* Technical specifications pag. 171

** Specifiche a pag. 172
** Technical specifications pag. 172



9 MM

Mosaico NON RETT
30x30 12"x12"
7351015 Matt
7351025 Lucido



Battiscopa
RETT
7,5x60 3"x24"
8200489 Matt
8200459 Lucido

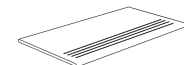

Step
ROC RETT
30x60 12"x24"
8200026

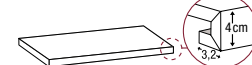

Gradone costa retta
RETT
33,3x120x4
13"x47"x1,57"
7350900 Matt
7350910 Lucido

Ang. SX
7350902 Matt
7350912 Lucido

Ang. DX
7350901 Matt
7350911 Lucido

ARNI BOOKMATCH 160x320



D1

D2

12 MM

NON RETT

160x320 63"x126"
Arni D1 **T617046** Matt
Arni D2 **T617047** Matt

160x320 63"x126"
Arni D1 **T617065** Lucido
Arni D2 **T617066** Lucido

Le due facce A1 e A2 di 160x320 devono essere **necessariamente acquistate insieme**.
Immagini puramente indicative: potrebbe presentarsi una discontinuità di vena da una lastra e l'altra.
L'eventuale differenza tra una lastra e l'altra fino a 2 cm sono perciò da considerarsi caratteristica del prodotto stesso.

* Stuoia in fibra di vetro nel retropiastrella disponibile a richiesta.

The two faces A1 and A2 in 160x320 cm (63"x126") are only sold together in bundle.
Images are purely indicative: a light vein discontinuity from one slab to the next can occur. Therefore differences up to 2 Cm from one slab to the next are admitted and considered a characteristic of the product itself.

* fiber glass back available on demand

Les deux plaques: A1 et A2 du 160x320 doivent être obligatoirement achetées ensemble.
Images purement indicatives: une discontinuité niveau veines d'une lame à l'autre parfois pourrait se présenter.
L'éventuelle différence entre lames de 2 cm doit être considérées une caractéristique du produit en soi.

Die platten A1 und A2 in 160x320 werden nur in kombination verkauft.
Die bilder stellen nur eine richtlinie dar.
Es kann vorkommen, dass die aderung von einer platte zu der anderer nicht ganz genau weiterlaeuft und eine toleranz von bis zu 2 Cm ist als eigenschaft des produktes zu betrachten.

ARNI BOOKMATCH 120x278

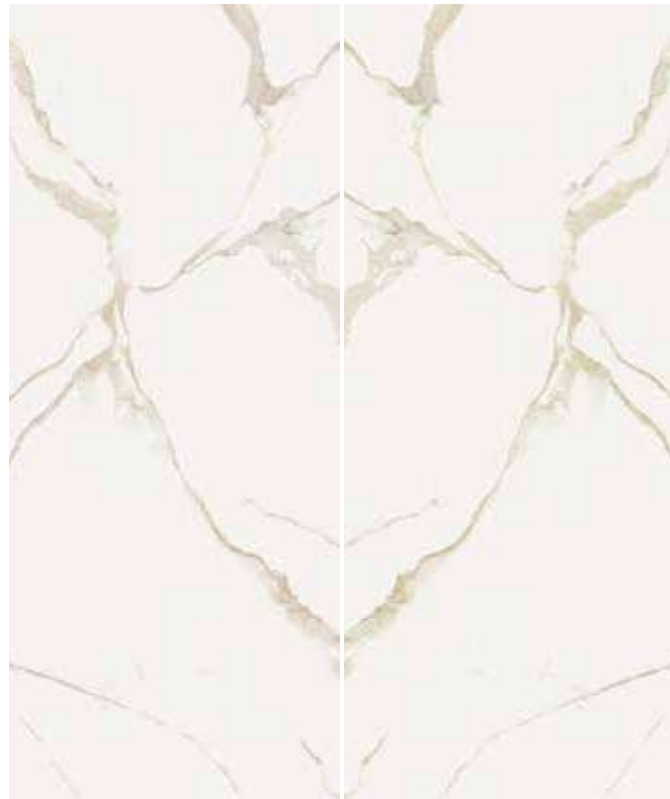

F B

6 MM

RETT

120x278 47"x109,45"
Arni F **T200057** Matt
Arni B **T200056** Matt

120x278 47"x109,45"
Arni F **T200054** Lucido
Arni B **T200053** Lucido

Immagini puramente indicative:
potrebbe presentarsi una discontinuità di vena da una Lastra e l'altra. L'eventuale differenza tra una lastra e l'altra fino a 2 cm sono perciò da considerarsi caratteristica del prodotto stesso.

Images are purely indicative:
a light vein discontinuity from one slab to the next can occur. Therefore differences up to 2 Cm from one slab to the next are admitted and considered a characteristic of the product itself.

Images purement indicatives:
une discontinuité niveau veines d'une lame à l'autre parfois pourrait se présenter. L'éventuelle différence entre lames de 2 cm doit être considérées une caractéristique du produit en soi.

Die bilder stellen nur eine richtlinie dar.
Es kann Vorkommen, dass die aderung von einer platte Zu der anderer nicht ganz genau weiterlaeuft Und Eine toleranz von bis zu 2 Cm ist als eigenschaft Des produktes zu betrachten.

ARNI RUNNING VEIN 90x270



A B C D E

6 MM

RETT

90x270 36"x106"
Arni A **T222546** Matt
Arni B **T222547** Matt
Arni C **T222548** Matt
Arni D **T222549** Matt
Arni E **T222550** Matt

90x270 36"x106"
Arni A **T222565** Lucido
Arni B **T222566** Lucido
Arni C **T222567** Lucido
Arni D **T222568** Lucido
Arni E **T222569** Lucido

Immagini puramente indicative:
potrebbe presentarsi una discontinuità di vena da una Lastra e l'altra. L'eventuale differenza tra una lastra e l'altra fino a 2 cm sono perciò da considerarsi caratteristica del prodotto stesso.

Images are purely indicative:
a light vein discontinuity from one slab to the next can occur. Therefore differences up to 2 Cm from one slab to the next are admitted and considered a characteristic of the product itself.

Images purement indicatives:
une discontinuité niveau veines d'une lame à l'autre parfois pourrait se présenter. L'éventuelle différence entre lames de 2 cm doit être considérées une caractéristique du produit en soi.

Die bilder stellen nur eine richtlinie dar.
Es kann Vorkommen, dass die aderung von einer platte Zu der anderer nicht ganz genau weiterlaeuft Und Eine toleranz von bis zu 2 Cm ist als eigenschaft Des produktes zu betrachten.

Canova

GREYSTONE

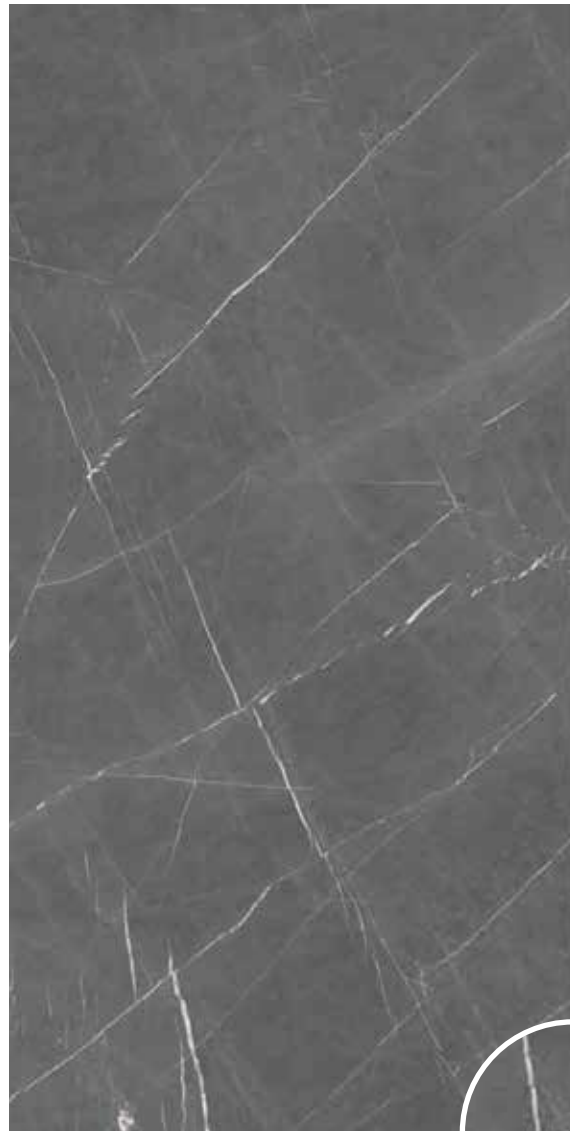

12 MM

NON RETT

160x320 63"x126"
T616246 Matt
T616086 Lucido

9 MM

RETT

60x120 24"x47"
8200299 Matt
8200199 Lucido

60x60 24"x24"
8200319 Matt
8200159 Lucido

30x60 12"x24"
8200309 Matt
8200169 Lucido

6 MM

RETT

120x278 47"x109,45"
T200052 Matt

120x120 47"x47"
T811875 Matt
T811905 Lucido

60x120 24"x47"
T820315 Matt
T820375 Lucido

90x270 36"x106"
T202205 Matt
T202245 Lucido



Battiscopa
 RETT
 7,5x60 3"x24"
8204319 Matt
8204159 Lucido

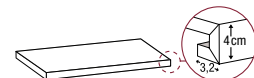

Gradone costa retta
 RETT
 33,3x120x4
 13"x47"x1,57"
7331476 Matt
7331486 Lucido

Ang. SX
7331478 Matt
7331488 Lucido

Ang. DX
7331477 Matt
7331487 Lucido



9 MM

Mosaico NON RETT
 30x30 12"x12"
7331445 Matt
7331455 Lucido

BELLAGIO

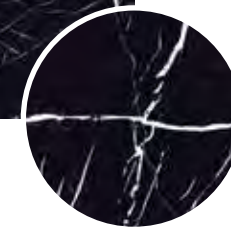

9 MM

RETT

60x120 24"x47"
8201236 Matt
8201019 Lucido

60x60 24"x24"
8201239 Matt
8261039 Lucido

30x60 12"x24"
8201237 Matt
8201029 Lucido



Battiscopa
 RETT
 7,5x60 3"x24"
8201240 Matt
8201038 Lucido

6 MM

RETT

120x278 47"x109,45"
T200050 Matt
T200051 Lucido

120x120 47"x47"
T823266 Matt
T823265 Lucido

60x120 24"x47"
T823276 Matt
T823275 Lucido

90x270 36"x106"
T202215 Matt
T202255 Lucido

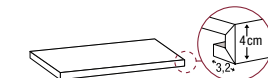

Gradone costa retta
 RETT
 33,3x120x4
 13"x47"x1,57"
7201238 Matt
7201158 Lucido

Ang. SX
7200240 Matt
7201160 Lucido

Ang. DX
7201259 Matt
7201159 Lucido



9 MM

Mosaico NON RETT
 30x30 12"x12"
7201239 Matt
7201039 Lucido

Canova

BARGA

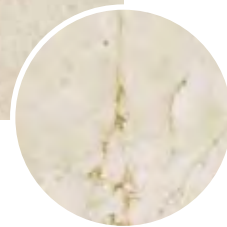

9 MM

Mosaico NON RETT
30x30 12"x12"
7330035 Lucido

9 MM

RETT

60x120 24"x47"
8200099 Lucido

60x60 24"x24"
8200119 Lucido

30x60 12"x24"
8200109 Lucido



Battiscopa
RETT
7,5x60 3"x24"
8204119 Lucido

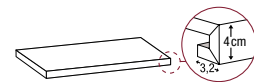

Gradone costa retta
RETT
33,3x120x4
13"x47"x1,57"
7351256 Lucido

Angolare
SX 7351258 Lucido
DX 7351257 Lucido

VARENNA

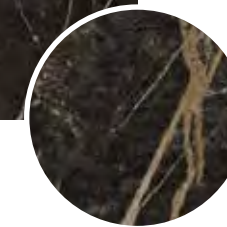

9 MM

Mosaico NON RETT
30x30 12"x12"
7351105 Lucido

9 MM

RETT

60x120 24"x47"
8200129 Lucido

60x60 24"x24"
8200149 Lucido

30x60 12"x24"
8200139 Lucido



Battiscopa
RETT
7,5x60 3"x24"
8204149 Lucido

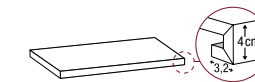

Gradone costa retta
RETT
33,3x120x4
13"x47"x1,57"
7350890 Lucido

Angolare
SX 7350892 Lucido
DX 7350891 Lucido

COLLEMANDINA

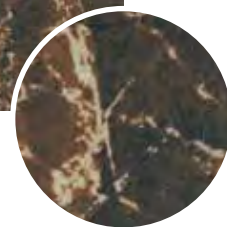

9 MM

Mosaico NON RETT
30x30 12"x12"
7351145 Lucido

9 MM

RETT

60x120 24"x47"
8350879 Lucido

60x60 24"x24"
8329775 Lucido

30x60 12"x24"
8329875 Lucido



Battiscopa
RETT
7,5x60 3"x24"
8329776 Lucido

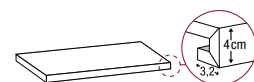

Gradone costa retta
RETT
33,3x120x4
13"x47"x1,57"
7350880 Lucido

Angolare
SX 7350882 Lucido
DX 7350881 Lucido

Canova

DECORI

Decors / Décorations / Dekorationen

9 MM

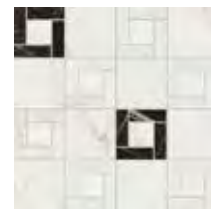

Mosaico GLAM
ARNI / VARENNA
NON RETT

30x30 12"x12"
7351155 Lucido

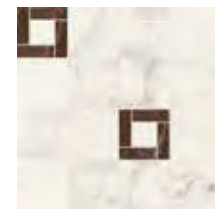

Mosaico GLAM
LUNI / COLLEMANDINA
NON RETT

30x30 12"x12"
7351165 Lucido

9 MM

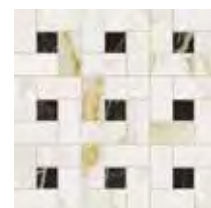

Mosaico SHINE
ARNI / VARENNA
NON RETT

30x30 12"x12"
7351175 Lucido

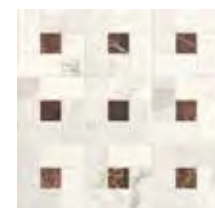

Mosaico SHINE
LUNI / COLLEMANDINA
NON RETT

30x30 12"x12"
7351185 Lucido



REAL MARBLE LONDON

4x29,5 1,6"x11,61"
7688089 Lucido

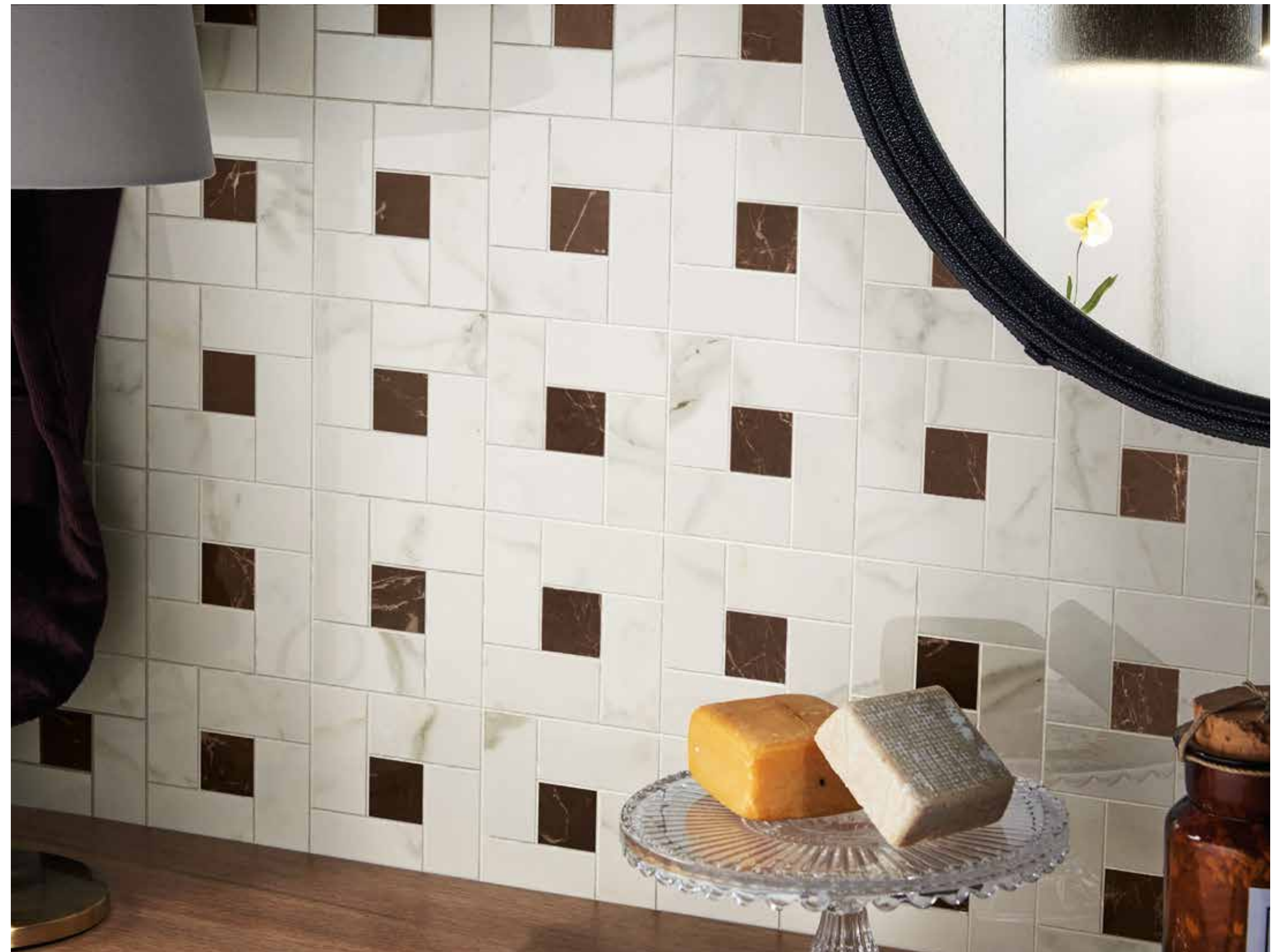

Marvilla

Gres Porcellanato

Porcelained stoneware
Grès cérame
Feinsteinzeug

Spessore / Thickness



9 MM
6 MM

Finiture / Finishes

RT M / Rettificato Matt
RT LU / Rettificato Lucido
RT TOUCH / Rettificato Touch

Le grafiche possono presentare delle differenze in base allo spessore del materiale

The patterns may present differences according to the thickness of the material
Les graphiques peuvent presenter des differences selon l'epaisseur du materiau
Die grafiken können unterschiede je nach materialstärke darstellen



Bla



V3



fuga
2MM
Rett

Bia GL

CE

Packaging pag. 316

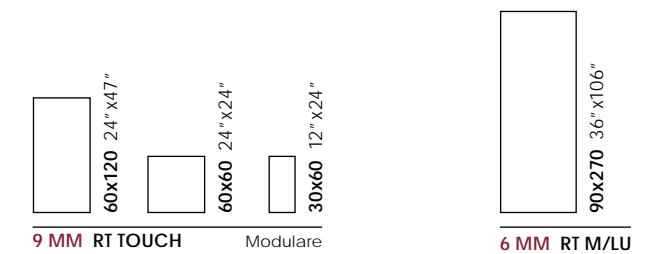
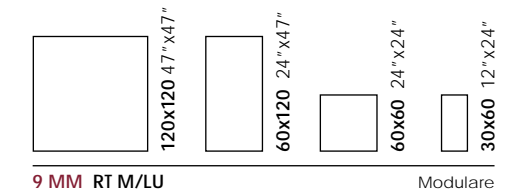

Only: Bernini, Borromini, Cellini, Michelangelo, Palladio

MARVILLA TOUCH

Touch è realizzato con materie prime particolarmente pregiate e sottoposto a successive lavorazioni che consentono di realizzare lastre con effetti di bassorilievo e dalla finitura extra morbida. Touch è il risultato di un innovativo processo produttivo che esalta la naturalezza del prodotto e per questo si consiglia l'utilizzo di materiali abrasivi o prodotti a forte attacco acido e l'uso in ambienti ad alto traffico.

Touch is made from particularly precious raw materials, processed to create bas-relief-effect slabs with an extra-smooth finish. Touch is the result of an innovative production process that enhances the natural features of the product: for this reason, we advise against the use of abrasive or highly aggressive acid products or laying in spaces with a high footfall.

Touch est réalisée à partir de matières premières de qualité supérieure et soumise à des traitements qui permettent de créer des dalles aux surfaces ultra douces arborant des effets de bas-reliefs. Touch est issue d'un tout nouveau processus de production qui valorise le caractère naturel du produit, c'est pourquoi il est déconseillé de l'appliquer dans des espaces très fréquentés et d'utiliser des produits abrasifs ou des détergents fortement acides pour son entretien.

Touch wird aus besonders edlen Rohstoffen gefertigt, aus denen nach weiterer Bearbeitung Großformatplatten mit Flachrelief und extraweicher Oberfläche entstehen. Touch ist das Ergebnis eines innovativen Herstellungsverfahrens, das die Natürlichkeit des Produkts zur Geltung bringt. Von der Verwendung von Scheuermitteln oder säurehaltigen Produkten und vom Einsatz in stark begangenen Bereichen wird daher abgeraten.

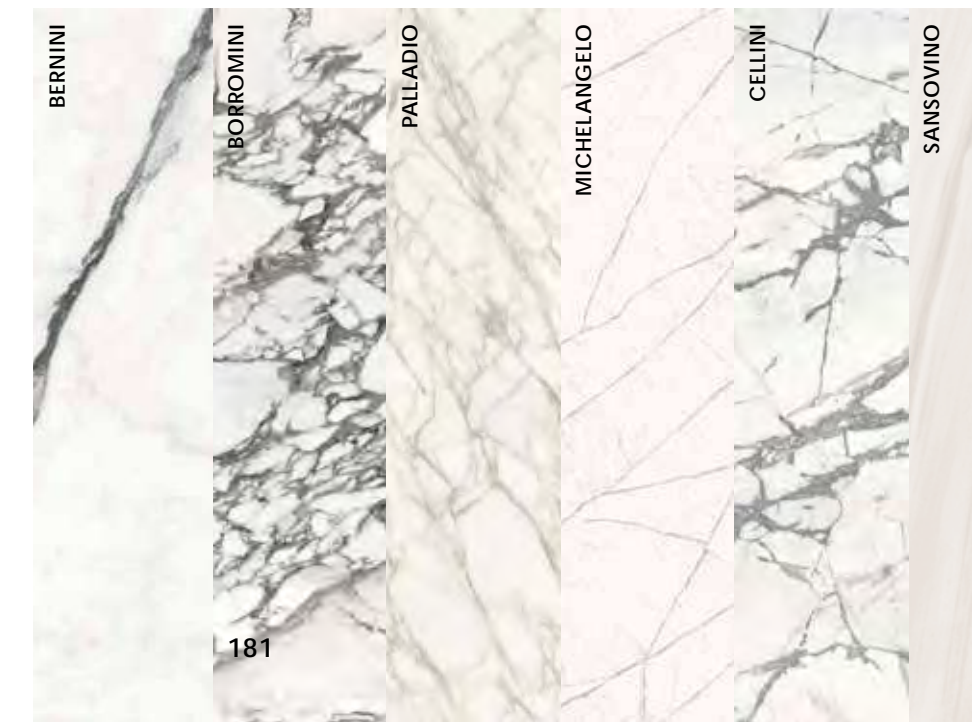

MARVILLA
Cellini



MARVILLA
Bernini 60x120 24"x47" Rett Lucido



MARVILLA
Cellini 120x120 47"x47" Rett Lucido
CEMENTART
Ibisco 120x278 47"x109,45" Rett



MARVILLA
Palladio 90x270 36"x106" Rett Lucido



MARVILLA
Borromini 60x120 24" x47" Rett Touch



MARVILLA
 Bernini 60x60 24"x24" Rett Touch
 Bernini mosaico losanga 36,1x57,6 14,21"x22,67" Touch non rett.



MARVILLA
 Cellini 60x120 24"x47" Rett touch
 Cellini 60x60 24"x24" Rett touch

Marvilla

BERNINI



9 MM

RETT

120x120 47"x47"
T200040 Matt
T200041 Lucido

60x120 24"x47"
8202001 Matt
8202011 Lucido
8202008 Touch

60x60 24"x24"
8202002 Matt
8202012 Lucido
8202029 Touch

30x60 12"x24"
8202003 Matt
8202013 Lucido
8202059 Touch

6 MM

RETT

90x270 36"x106"
T203004 Matt
T203007 Lucido

Battiscopa

RETT

7,5x60 3"x24"
8202004 Matt
8202014 Lucido



Gradone costa retta

RETT

33,3x120x4
 13"x47"x1,57"
8202007 Matt
8202017 Lucido

Ang. SX

8202006 Matt
8202016 Lucido

Ang. DX

8202005 Matt
8202015 Lucido



9 MM

Mosaico NON RETT
 30x30 12"x12"
7202003 Matt
7202001 Lucido



9 MM

Losanga NON RETT
 36,1x57,6 14,21"x22,67"
8200364 Touch

BORROMINI



9 MM

RETT

120x120 47"x47"
T200042 Matt
T200043 Lucido

60x120 24"x47"
8202021 Matt
8202031 Lucido
8202009 Touch

60x60 24"x24"
8202022 Matt
8202032 Lucido
8202038 Touch

30x60 12"x24"
8202023 Matt
8202033 Lucido
8202069 Touch

6 MM

RETT

90x270 36"x106"
T203024 Matt
T203027 Lucido



Battiscopa

RETT

7,5x60 3"x24"
8202024 Matt
8202034 Lucido



Gradone costa retta

RETT

33,3x120x4
 13"x47"x1,57"
8202027 Matt
8202037 Lucido

Ang. SX

8202026 Matt
8202036 Lucido

Ang. DX

8202025 Matt
8202035 Lucido



9 MM

Mosaico NON RETT
 30x30 12"x12"
7202002 Matt
7202000 Lucido



9 MM

Losanga NON RETT
 36,1x57,6 14,21"x22,67"
8200384 Touch

Marvilla

CELLINI



9 MM

RETT

120x120 47"x47"
T200014 Matt
T200015 Lucido

60x120 24"x47"
8202041 Matt
8202051 Lucido
8202018 Touch

60x60 24"x24"
8202042 Matt
8202052 Lucido
8202039 Touch

30x60 12"x24"
8202043 Matt
8202053 Lucido
8202078 Touch



Battiscopa
 RETT
 7,5x60 3"x24"
8202044 Matt
8202054 Lucido

6 MM

RETT

90x270 36"x106"
T203044 Matt
T203047 Lucido



Gradone costa retta
 RETT
 33,3x120x4
 13"x47"x1,57"
8202047 Matt
8202057 Lucido

Ang. SX
8202046 Matt
8202056 Lucido

Ang. DX
8202045 Matt
8202055 Lucido



9 MM

Mosaico NON RETT
 30x30 12"x12"
7202043 Matt
7202004 Lucido



9 MM

Losanga NON RETT
 36,1x57,6 14,21"x22,67"
8200387 Touch

MICHELANGELO

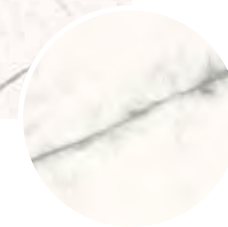
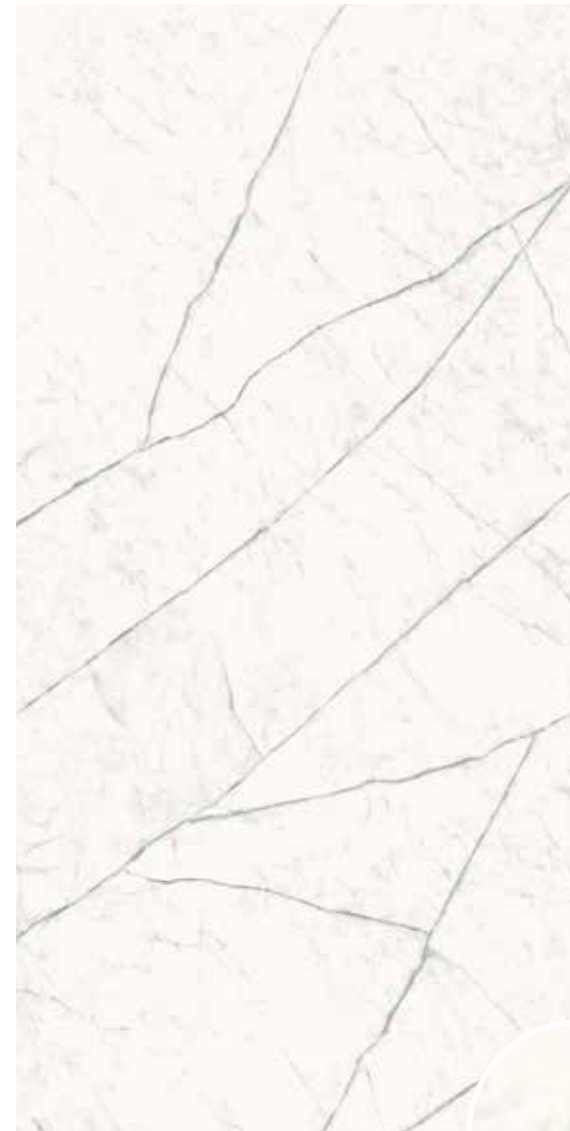

9 MM

RETT

120x120 47"x47"
T200016 Matt
T200017 Lucido

60x120 24"x47"
8202061 Matt
8202071 Lucido
8202019 Touch

60x60 24"x24"
8202062 Matt
8202072 Lucido
8202048 Touch

30x60 12"x24"
8202063 Matt
8202073 Lucido
8202079 Touch



Battiscopa
 RETT
 7,5x60 3"x24"
8202064 Matt
8202074 Lucido



9 MM

Mosaico NON RETT
 30x30 12"x12"
7202063 Matt
7202073 Lucido



9 MM

Losanga NON RETT
 36,1x57,6 14,21"x22,67"
8200388 Touch

6 MM

RETT

90x270 36"x106"
T203064 Matt
T203067 Lucido



Gradone costa retta
 RETT
 33,3x120x4
 13"x47"x1,57"
8202067 Matt
8202077 Lucido

Ang. SX
8202066 Matt
8202076 Lucido

Ang. DX
8202065 Matt
8202075 Lucido

Marvilla

PALLADIO



9 MM

RETT

120x120 47"x47"
T200020 Matt
T200022 Lucido

60x120 24"x47"
8202081 Matt
8202091 Lucido
8202028 Touch

60x60 24"x24"
8202082 Matt
8202092 Lucido
8202049 Touch

30x60 12"x24"
8202083 Matt
8202093 Lucido
8202088 Touch

6 MM

RETT

90x270 36"x106"
T203084 Matt
T203087 Lucido

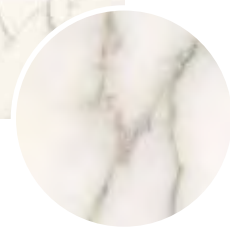

Battiscopa
 RETT
 7,5x60 3"x24"
8202084 Matt
8202094 Lucido

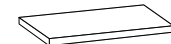

Gradone costa retta
 RETT
 33,3x120x4
 13"x47"x1,57"
8202087 Matt
8202097 Lucido

Ang. SX
8202086 Matt
8202096 Lucido

Ang. DX
8202085 Matt
8202095 Lucido



9 MM

Mosaico NON RETT
 30x30 12"x12"
7202083 Matt
7202093 Lucido



9 MM

Losanga NON RETT
 36,1x57,6 14,21"x22,67"
8200389 Touch

SANSOVINO



9 MM

RETT

120x120 47"x47"
T200018 Matt
T200019 Lucido

60x120 24"x47"
8202101 Matt
8202111 Lucido

60x60 24"x24"
8202102 Matt
8202112 Lucido

30x60 12"x24"
8202103 Matt
8202113 Lucido

6 MM

RETT

90x270 36"x106"
T203104 Matt
T203107 Lucido



Battiscopa
 RETT
 7,5x60 3"x24"
8202104 Matt
8202114 Lucido

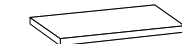

Gradone costa retta
 RETT
 33,3x120x4
 13"x47"x1,57"
8202107 Matt
8202117 Lucido

Ang. SX
8202106 Matt
8202116 Lucido

Ang. DX
8202105 Matt
8202115 Lucido



9 MM

Mosaico NON RETT
 30x30 12"x12"
7202103 Matt
7202113 Lucido

Palatina

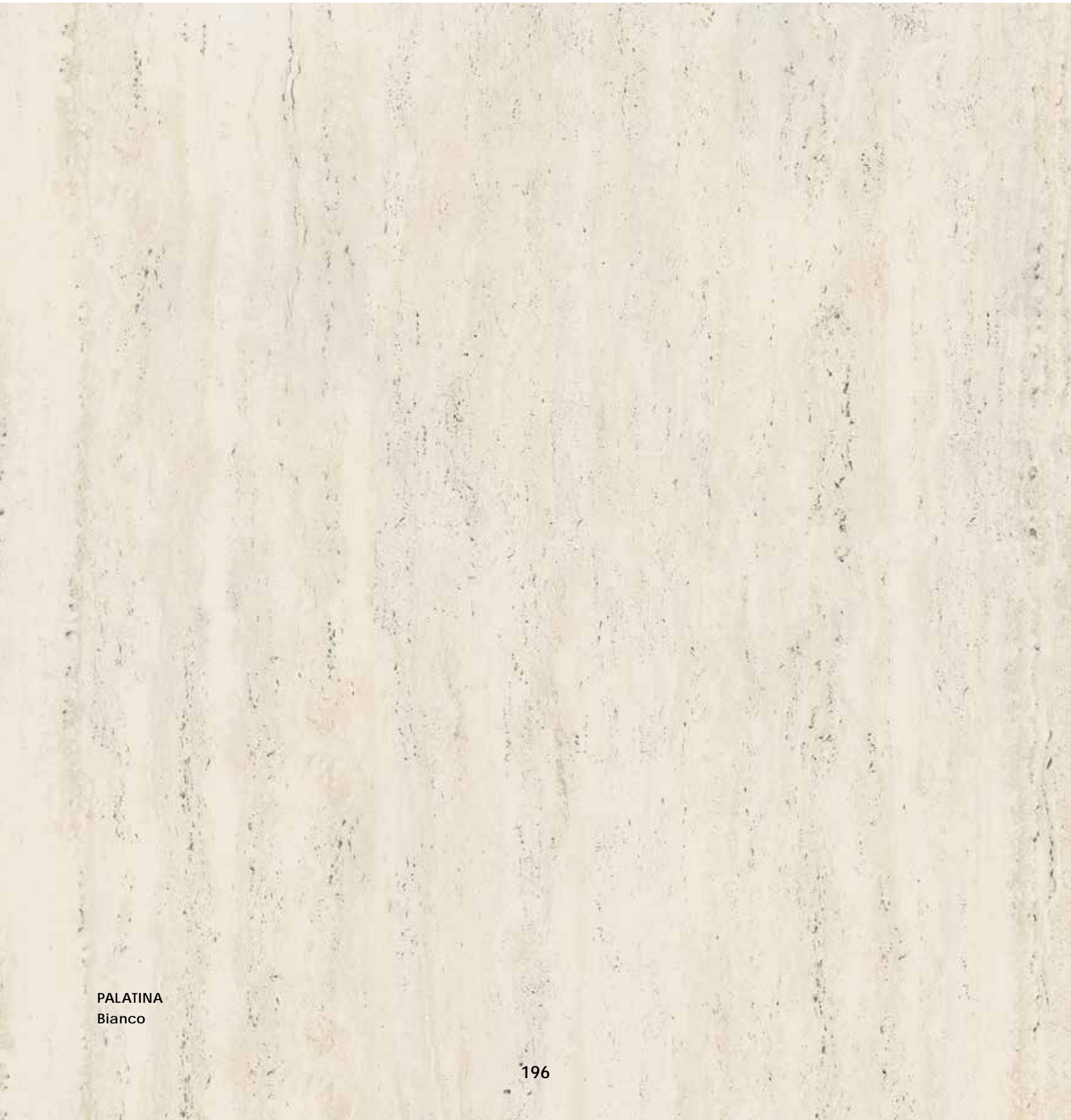

PALATINA
Bianco

Gres Porcellanato

Porcelained stoneware
Grès cérame
Feinsteinzeug

Spessore / Thickness



9 MM

Finiture / Finishes

RT / Rettificato
RT LU / Rettificato Lucido
RT GR / Rettificato Grip

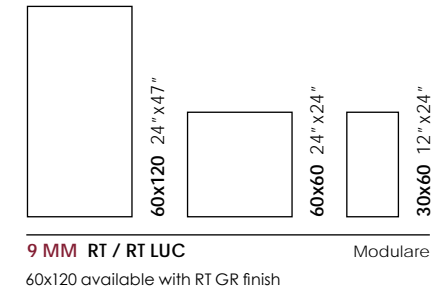

Bla



V3



fuga
2MM
Rett



R11
GRIP



A+B+C
GRIP

Bia GL

CE

Packaging pag. 316



BIANCO

GRIGIO

CREMA

GOLD



PALATINA

Indoor: Bianco 60x120 24"x47" Rett Lucido, 60x120 24"x47" Rett

Outdoor: Bianco 60x120 24"x47" Rett Grip

Palatina

BIANCO



9 MM

RETT

60x120 24"x47"
8200063 Matt
8200067 Lucido

60x60 24"x24"
8200064 Matt
8200068 Lucido

30x60 12"x24"
8200065 Matt
8200073 Lucido

GRIP RETT - R11

60x120 24"x47"
8200075



9 MM

Mosaico NON RETT
 30x30 12"x12"
7278805 Matt
7278855 Lucido



Battiscopa

RETT

7,5x60 3"x24"
8200076 Matt
8200077 Lucido

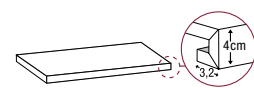

Gradone costa retta
 Angolare DX/SX

RETT

33,3x120x4 13"x47"x1,57"
SU RICHIESTA. ON DEMAND.
SUR DEMANDE. AUF ANFRAGE

GRIGIO



9 MM

RETT

60x120 24"x47"
8200033 Matt
8200043 Lucido

60x60 24"x24"
8200034 Matt
8200044 Lucido

30x60 12"x24"
8200035 Matt
8200045 Lucido

GRIP RETT - R11

60x120 24"x47"
8200056



9 MM

Mosaico NON RETT
 30x30 12"x12"
7278835 Matt
7278885 Lucido



Battiscopa

RETT

7,5x60 3"x24"
8200046 Matt
8200047 Lucido

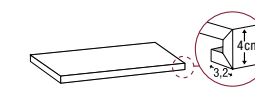

Gradone costa retta
 Angolare DX/SX

RETT

33,3x120x4 13"x47"x1,57"
SU RICHIESTA. ON DEMAND.
SUR DEMANDE. AUF ANFRAGE

Palatina

CREMA

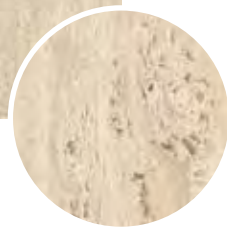

9 MM

RETT

60x120 24"x47"
8200006 Matt
8200012 Lucido

60x60 24"x24"
8200007 Matt
8200013 Lucido

30x60 12"x24"
8200008 Matt
8200014 Lucido

GRIP RETT - R11

60x120 24"x47"
8200055



9 MM

Mosaico NON RETT
30x30 12"x12"
7278815 Matt
7278865 Lucido



Battiscopa
RETT

7,5x60 3"x24"
8200015 Matt
8200022 Lucido

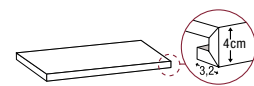

Gradone costa retta
Angolare DX/SX

RETT
33,3x120x4 13"x47"x1,57"

SU RICHIESTA. ON DEMAND.
SUR DEMANDE. AUF ANFRAGE

GOLD

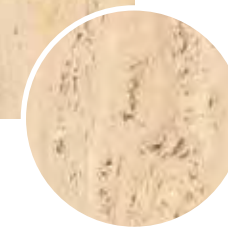

9 MM

RETT

60x120 24"x47"
8200016 Matt
8200023 Lucido

60x60 24"x24"
8200017 Matt
8200024 Lucido

30x60 12"x24"
8200018 Matt
8200025 Lucido

GRIP RETT - R11

60x120 24"x47"
8200057



9 MM

Mosaico NON RETT
30x30 12"x12"
7278825 Matt
7278875 Lucido

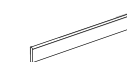

Battiscopa
RETT

7,5x60 3"x24"
8200032 Matt
8200042 Lucido

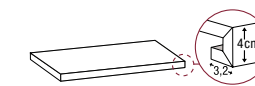

Gradone costa retta
Angolare DX/SX

RETT
33,3x120x4 13"x47"x1,57"

SU RICHIESTA. ON DEMAND.
SUR DEMANDE. AUF ANFRAGE

i Cementi

Concrete effect
Cotto Imitation ciments
Beton-Optik

Cementart	206
Crossover	222
Garda	232
Kompakt	244
Materika	252
Stucchi	260
Venexia	268

Cementart



Gres Porcellanato

Porcelained stoneware
Grès cérame
Feinsteinzeug

Spessore / Thickness



20 MM
9 MM
6 MM

Finiture / Finishes

RT / Rettificato
RT GR / Rettificato Grip
NRT / Non Rettificato
NRT ROC / Non Rettificato ROC

Su richiesta / On demand

Pezzi speciali 20MM /
Trims 20MM

pag. 338

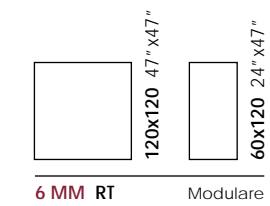
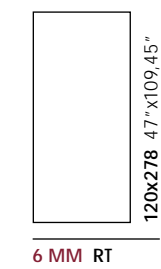
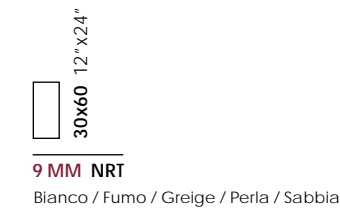
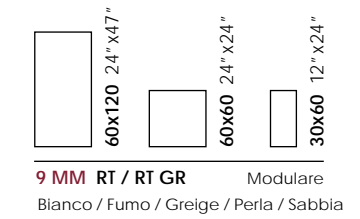

Bla



V3



fuga
2MM
Rett



fuga
> 3MM
Non Rett



R11
GRIP
ROC



A+B+C
GRIP
ROC

Bia GL

CE

Packaging pag. 317

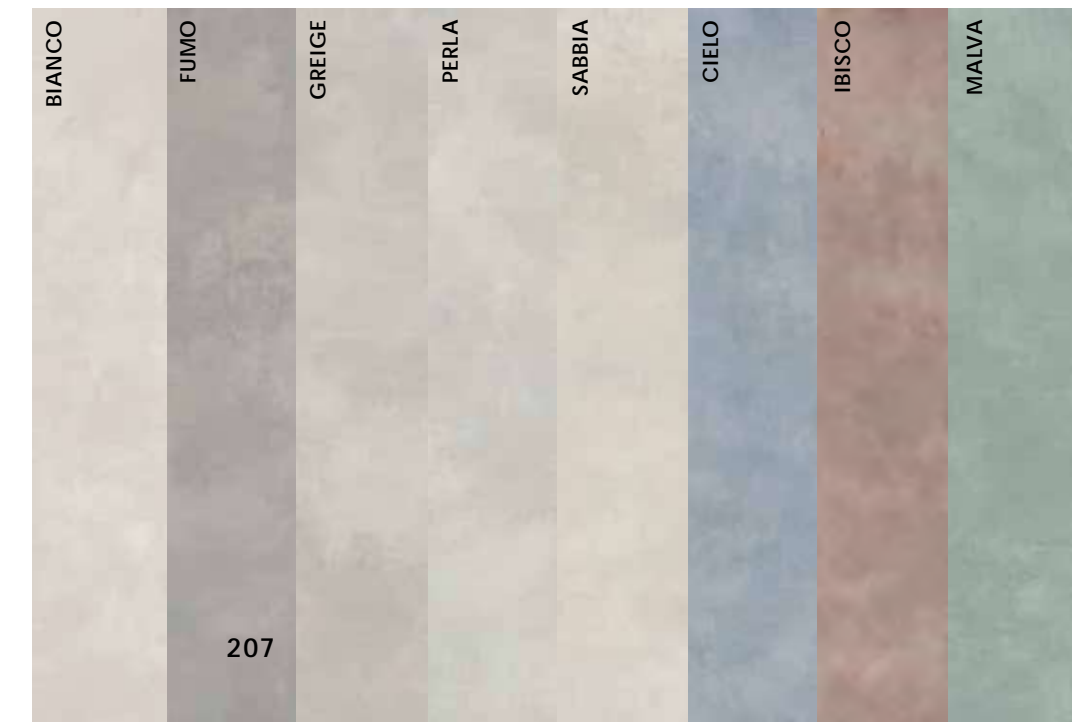



Floor Outdoor: CEMENTART Fumo 60x120 24"x47" Rett Grip
Wall: CEMENTART Fumo 120x120 47"x47" Rett



Floor: CEMENTART Cielo 120x120 47"x47" Rett
Wall: CEMENTART Cielo 120x278 47"x109,45" Rett



Floor: CEMENTART Greige 120x120 47"x47" Rett
Wall: CEMENTART Greige Losanga 36,1x57,6 14,21"x22,67"



Wall: CEMENTART Malva 120x278 47"x109,45" Rett
Floor: CEMENTART Perla 120x120 47"x47" Rett

BIANCO



20 MM

GRIP RETT

60x120 24"x47"
8200785

60x60 24"x24"
8200786

9 MM

RETT

60x120 24"x47"
8200547

60x60 24"x24"
8200732

30x60 12"x24"
8200737

NON RETT

30x60 12"x24"
7200043

GRIP RETT

60x120 24"x47"
8200744

60x60 24"x24"
8200749

30x60 12"x24"
8200755

ROC NON RETT

30x60 12"x24"
7200046

6 MM

RETT

120x278 47"x109,45"
T200089

120x120 47"x47"
T200101

60x120 24"x47"
T200108



9 MM
Esagoni NON RETT
27,4x31,7 10,78"x12,48"
8200767



9 MM
Losanga NON RETT
36,1x57,6 14,21"x22,67"
8200658



Battiscopa
RETT
7,5x60 3"x24"
8200818

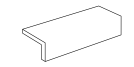

Elemento ad L
ROC
4x15x30 1,57"x6"x12"
7200065

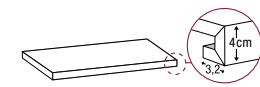

Gradone costa retta
Angolare DX/SX
RETT
33,3x120x4 13"x47"x1,57"
SU RICHIESTA. ON DEMAND.
SUR DEMANDE. AUF ANFRAGE

FUMO



20 MM

GRIP RETT

60x120 24"x47"
8200761

60x60 24"x24"
8200762

9 MM

RETT

60x120 24"x47"
8200548

60x60 24"x24"
8200733

30x60 12"x24"
8200738

NON RETT

30x60 12"x24"
7200047

GRIP RETT

60x120 24"x47"
8200745

60x60 24"x24"
8200751

30x60 12"x24"
8200756

ROC NON RETT

30x60 12"x24"
7200048

6 MM

RETT

120x278 47"x109,45"
T200090

120x120 47"x47"
T200102

60x120 24"x47"
T200109



9 MM
Esagoni NON RETT
27,4x31,7 10,78"x12,48"
8200768



9 MM
Losanga NON RETT
36,1x57,6 14,21"x22,67"
8200659



Battiscopa
RETT
7,5x60 3"x24"
8200819

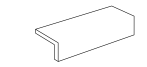

Elemento ad L
ROC
4x15x30 1,57"x6"x12"
7200066

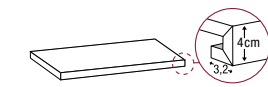

Gradone costa retta
Angolare DX/SX
RETT
33,3x120x4 13"x47"x1,57"
SU RICHIESTA. ON DEMAND.
SUR DEMANDE. AUF ANFRAGE

GREIGE



9 MM

RETT

60x120 24"x47"
8200549

60x60 24"x24"
8200734

30x60 12"x24"
8200739

NON RETT

30x60 12"x24"
7200049

GRIP RETT

60x120 24"x47"
8200746

60x60 24"x24"
8200752

30x60 12"x24"
8200757

ROC NON RETT

30x60 12"x24"
7200050

6 MM

RETT

120x278 47"x109,45"
T200091

120x120 47"x47"
T200103

60x120 24"x47"
T200110



9 MM
Esagoni NON RETT
27,4x31,7 10,78"x12,48"
8200769



9 MM
Losanga NON RETT
36,1x57,6 14,21"x22,67"
8200664



Battiscopa
RETT
7,5x60 3"x24"
8200828

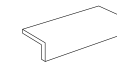

Elemento ad L
ROC
4x15x30 1,57"x6"x12
7200068

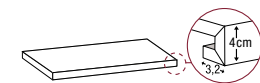

Gradone costa retta
Angolare DX/SX
RETT
33,3x120x4 13"x47"x1,57"
SU RICHIESTA. ON DEMAND.
SUR DEMANDE. AUF ANFRAGE

PERLA



20 MM

GRIP RETT

60x120 24"x47"
8200765

60x60 24"x24"
8200766

9 MM

RETT

60x120 24"x47"
8200552

60x60 24"x24"
8200735

30x60 12"x24"
8200742

NON RETT

30x60 12"x24"
7200051

GRIP RETT

60x120 24"x47"
8200747

60x60 24"x24"
8200753

30x60 12"x24"
8200758

ROC NON RETT

30x60 12"x24"
7200053



9 MM
Esagoni NON RETT
27,4x31,7 10,78"x12,48"
8200771



9 MM
Losanga NON RETT
36,1x57,6 14,21"x22,67"
8200665



Battiscopa
RETT
7,5x60 3"x24"
8200829

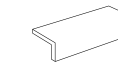

Elemento ad L
ROC
4x15x30 1,57"x6"x12
7200069

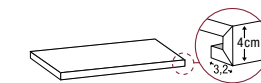

Gradone costa retta
Angolare DX/SX
RETT
33,3x120x4 13"x47"x1,57"
SU RICHIESTA. ON DEMAND.
SUR DEMANDE. AUF ANFRAGE

SABBIA



20 MM

GRIP RETT

60x120 24"x47"
8200763

60x60 24"x24"
8200764

9 MM

RETT

60x120 24"x47"
8200553

60x60 24"x24"
8200736

30x60 12"x24"
8200743

NON RETT

30x60 12"x24"
7200054

GRIP RETT

60x120 24"x47"
8200748

60x60 24"x24"
8200754

30x60 12"x24"
8200759

ROC NON RETT

30x60 12"x24"
7200055

6 MM

RETT

120x278 47"x109,45"
T200093

120x120 47"x47"
T200107

60x120 24"x47"
T200113



9 MM
Esagoni NON RETT
27,4x31,7 10,78"x12,48"
8200772



9 MM
Losanga NON RETT
36,1x57,6 14,21"x22,67"
8200666



Battiscopa
RETT
7,5x60 3"x24"
8200839

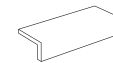

Elemento ad L
ROC
4x15x30 1,57"x6"x12"
7200070

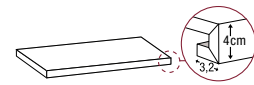

Gradone costa retta
Angolare DX/SX
RETT
33,3x120x4 13"x47"x1,57"
SU RICHIESTA. ON DEMAND.
SUR DEMANDE. AUF ANFRAGE

CIELO



6 MM

RETT

120x278 47"x109,45"
T200133

120x120 47"x47"
T200124

60x120 24"x47"
T200129

Cementart

IBISCO

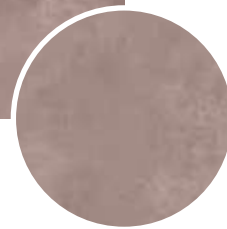

6 MM

RETT

120x278 47"x109,45"
T200134

120x120 47"x47"
T200126

60x120 24"x47"
T200130

MALVA

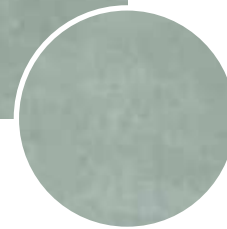

6 MM

RETT

120x278 47"x109,45"
T200135

120x120 47"x47"
T200128

60x120 24"x47"
T200132

Crossover



Gres Porcellanato

Porcelained stoneware
Grès cérame
Feinsteinzeug

Spessore / Thickness



10 MM
9 MM

Finiture / Finishes

RT / Rettificato

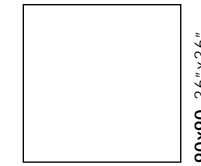

90x90 36"x36"

9 MM RT

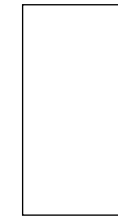

60x120 24"x47"

9 MM RT

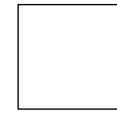

60x60 24"x24"

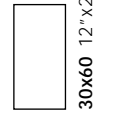

30x60 12"x24"

Modulare



Bla



V4



fuga
2MM
Rett

Bia GL

CE

Packaging pag. 317

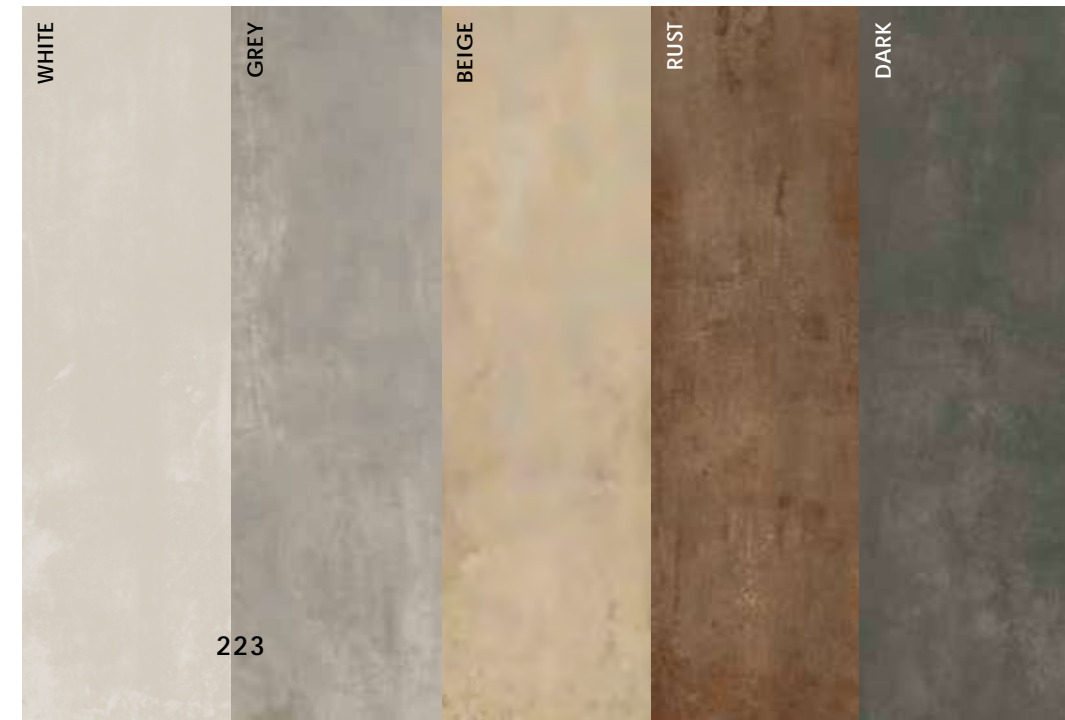



CROSSOVER
Rust 90x90 36"x36" Rett

Crossover

WHITE

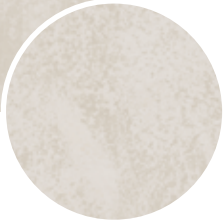

9 MM

RETT

60x120 24"x47"
8200951

60x60 24"x24"
8200950

30x60 12"x24"
8200952

90x90 36"x36"
8960919

GREY



9 MM

RETT

60x120 24"x47"
8200931

60x60 24"x24"
8200930

30x60 12"x24"
8200932

90x90 36"x36"
8960909

 **9 MM**
Mosaico NON RETT
30x30 12"x12"
7279801

 **Battiscopa**
RETT
7,5x60 3"x24"
8200955

 **Step**
RETT
30x60 12"x24"
8200954

 **9 MM**
Mosaico NON RETT
30x30 12"x12"
7279791

 **Battiscopa**
RETT
7,5x60 3"x24"
8200935

 **Step**
RETT
30x60 12"x24"
8200934

Crossover

BEIGE



9 MM

RETT

60x120 24"x47"
8200911

60x60 24"x24"
8200910

30x60 12"x24"
8200912

90x90 36"x36"
8960929



9 MM

Mosaico NON RETT
30x30 12"x12"
7279811



Battiscopa
RETT
7,5x60 3"x24"
8200915

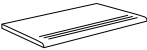

Step
RETT
30x60 12"x24"
8200914

RUST



9 MM

RETT

60x120 24"x47"
8200941

60x60 24"x24"
8200940

30x60 12"x24"
8200942

90x90 36"x36"
8960939



9 MM

Mosaico NON RETT
30x30 12"x12"
7279821



Battiscopa
RETT
7,5x60 3"x24"
8200945

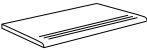

Step
RETT
30x60 12"x24"
8200944

Crossover

DARK



9 MM

RETT

60x120 24"x47"
8200921

60x60 24"x24"
8200920

30x60 12"x24"
8200922

90x90 36"x36"
8960899



9 MM

Mosaico NON RETT
30x30 12"x12"
7279781



Battiscopa
RETT
7,5x60 3"x24"
8200925

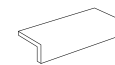

Step
RETT
30x60 12"x24"
8200924

230



CEMENTI

CROSSOVER
Dark 60x120 24"x47" Rett

231

Garda



Gres Porcellanato

Porcelained stoneware
Grès cérame
Feinsteinzeug

Spessore / Thickness



20 MM
10 MM
9 MM
6 MM

Finiture / Finishes

RT M / Rettificato Matt
NRT / Non Rettificato
RT GR / Rettificato Grip
NRT GR / Non Rettificato Grip

Su richiesta / On demand

Pezzi speciali 20MM /
Trims 20MM

pag. 338



Bla



V3



fuga
2MM
Rett



fuga
> 3MM
Nat



R11
GRIP



A+B+C
GRIP

Bia GL

CE

Packaging pag. 318

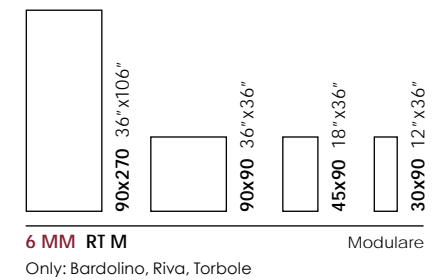
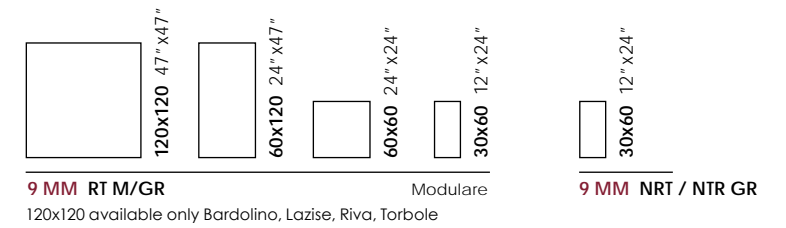
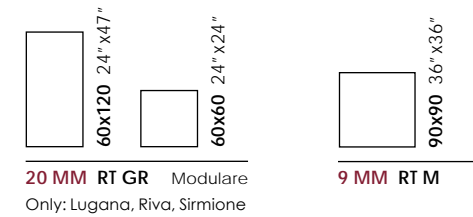



GARDA
Indoor: Sirmione 60x120 24"x47" Rett Matt
Outdoor: Sirmione 60x60x2 24"x24"x0,7" Rett Grip



GARDA
 Indoor: Riva 60x120 24"x47" Rett Matt - Outdoor: Riva 60x120x2 24"x47"x0,7" Rett Grip



Floor: **GARDA Bardolino 90x90 36"x36" Rett Matt**
 Wall: **GARDA Bardolino 30x90 12"x36" Rett Matt**
PASTELLI Turchese 30x90 12"x36" Rett Matt - Turchese muretto 30x30 12"x12"

Garda

RIVA



20 MM

GRIP RETT

60x120 24"x47"
7331937

60x60 24"x24"
8332015

9 MM

RETT

120x120 47"x47"
T200013 Matt

60x120 24"x47"
8200821 Matt

60x60 24"x24"
8200820 Matt

30x60 12"x24"
8200822 Matt

90x90 36"x36"
8351279 Matt

GRIP RETT

60x120 24"x47"
8200156

60x60 24"x24"
8200870

30x60 12"x24"
8200257

NON RETT

30x60 12"x24"
7279471

GRIP NON RETT

30x60 12"x24"
7279831



Battiscopa
RETT
7,5x60 3"x24"
8200823 Matt

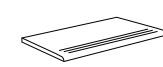

Step
RETT
30x60 12"x24"
8200824 Matt

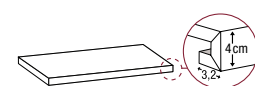

Gradone costa retta
RETT
33,3x120x4
13"x47"x1,57"
8200827 Matt

Angolare
DX **8200825** Matt
SX **8200826** Matt



9 MM
Mosaico NON RETT
30x30 12"x12"
7279721

LAZISE



9 MM

RETT

120x120 47"x47"
T200012 Matt

60x120 24"x47"
8200801 Matt

60x60 24"x24"
8200800 Matt

30x60 12"x24"
8200802 Matt

90x90 36"x36"
8351259 Matt

GRIP RETT

60x120 24"x47"
8200097

60x60 24"x24"
8200850

30x60 12"x24"
8200246

NON RETT

30x60 12"x24"
7279511

GRIP NON RETT

30x60 12"x24"
7279871



Battiscopa
RETT
7,5x60 3"x24"
8200803 Matt

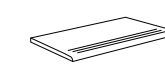

Step
RETT
30x60 12"x24"
8200804 Matt

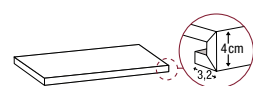

Gradone costa retta
RETT
33,3x120x4
13"x47"x1,57"
8200807 Matt

Angolare
DX **8200805** Matt
SX **8200806** Matt



9 MM
Mosaico NON RETT
30x30 12"x12"
7279761

LUGANA



20 MM

GRIP RETT

60x120 24"x47"
7331956

60x60 24"x24"
8331985

9 MM

RETT

60x120 24"x47"
8200811 Matt

60x60 24"x24"
8200810 Matt

30x60 12"x24"
8200812 Matt

90x90 36"x36"
8351269 Matt

GRIP RETT

60x120 24"x47"
8200098

60x60 24"x24"
8200860

30x60 12"x24"
8200256

NON RETT

30x60 12"x24"
7279501

GRIP NON RETT

30x60 12"x24"
7279861



Battiscopa
RETT
7,5x60 3"x24"
8200813 Matt

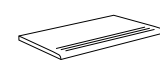

Step
RETT
30x60 12"x24"
8200814 Matt

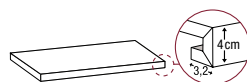

Gradone costa retta
RETT
33,3x120x4
13"x47"x1,57"
8200817 Matt

Angolare
DX **8200815** Matt
SX **8200816** Matt



9 MM

Mosaico NON RETT
30x30 12"x12"
7279751

BARDOLINO



9 MM

RETT

120x120 47"x47"
T200011 Matt

60x120 24"x47"
8200791 Matt

60x60 24"x24"
8200790 Matt

30x60 12"x24"
8200792 Matt

90x90 36"x36"
8351249 Matt

GRIP RETT

60x120 24"x47"
8200096

60x60 24"x24"
8200840

30x60 12"x24"
8200238

NON RETT

30x60 12"x24"
7279491

GRIP NON RETT

30x60 12"x24"
7279851

6 MM

RETT

90x270 36"x106"
T202175 Matt

90x90 36"x36"
T202055 Matt

45x90 18"x36"
T202085 Matt

30x90 12"x36"
T202115 Matt



Battiscopa
RETT
7,5x60 3"x24"
8200793 Matt

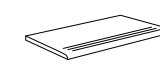

Step
RETT
30x60 12"x24"
8200794 Matt

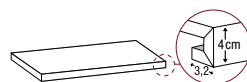

Gradone costa retta
RETT
33,3x120x4
13"x47"x1,57"
8200797 Matt

Angolare
DX **8200795** Matt
SX **8200796** Matt



9 MM

Mosaico NON RETT
30x30 12"x12"
7279741

TORBOLE



9 MM

RETT

120x120 47"x47"
T200034 Matt

60x120 24"x47"
8200831 Matt

60x60 24"x24"
8200830 Matt

30x60 12"x24"
8200832 Matt

90x90 36"x36"
8351299 Matt

GRIP RETT

60x120 24"x47"
8200181

60x60 24"x24"
8200890

30x60 12"x24"
8200258

NON RETT

30x60 12"x24"
7279481

GRIP NON RETT

30x60 12"x24"
7279841

6 MM

RETT

90x270 36"x106"
T202135 Matt

90x90 36"x36"
T202065 Matt

45x90 18"x36"
T202095 Matt

30x90 12"x36"
T202125 Matt



Battiscopa
RETT
7,5x60 3"x24"
8200833 Matt

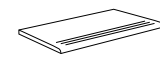

Step
RETT
30x60 12"x24"
8200834 Matt

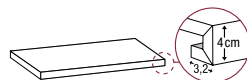

Gradone costa retta
RETT
33,3x120x4
13"x47"x1,57"
8200837 Matt

Angolare
DX **8200835** Matt
SX **8200836** Matt



9 MM

Mosaico NON RETT
30x30 12"x12"
7279731

SIRMIONE



20 MM

GRIP RETT

60x120 24"x47"
7331946

60x60 24"x24"
8332045

9 MM

RETT

60x120 24"x47"
8200901 Matt

60x60 24"x24"
8200900 Matt

30x60 12"x24"
8200902 Matt

90x90 36"x36"
8351289 Matt

GRIP RETT

60x120 24"x47"
8200237

60x60 24"x24"
8200880

30x60 12"x24"
8200266

NON RETT

30x60 12"x24"
7279521

GRIP NON RETT

30x60 12"x24"
7279881



Battiscopa
RETT
7,5x60 3"x24"
8200903 Matt

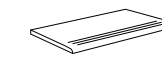

Step
RETT
30x60 12"x24"
8200904 Matt

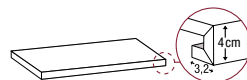

Gradone costa retta
RETT
33,3x120x4
13"x47"x1,57"
8200907 Matt

Angolare
DX **8200905** Matt
SX **8200906** Matt



9 MM

Mosaico NON RETT
30x30 12"x12"
7279771

Kompakt

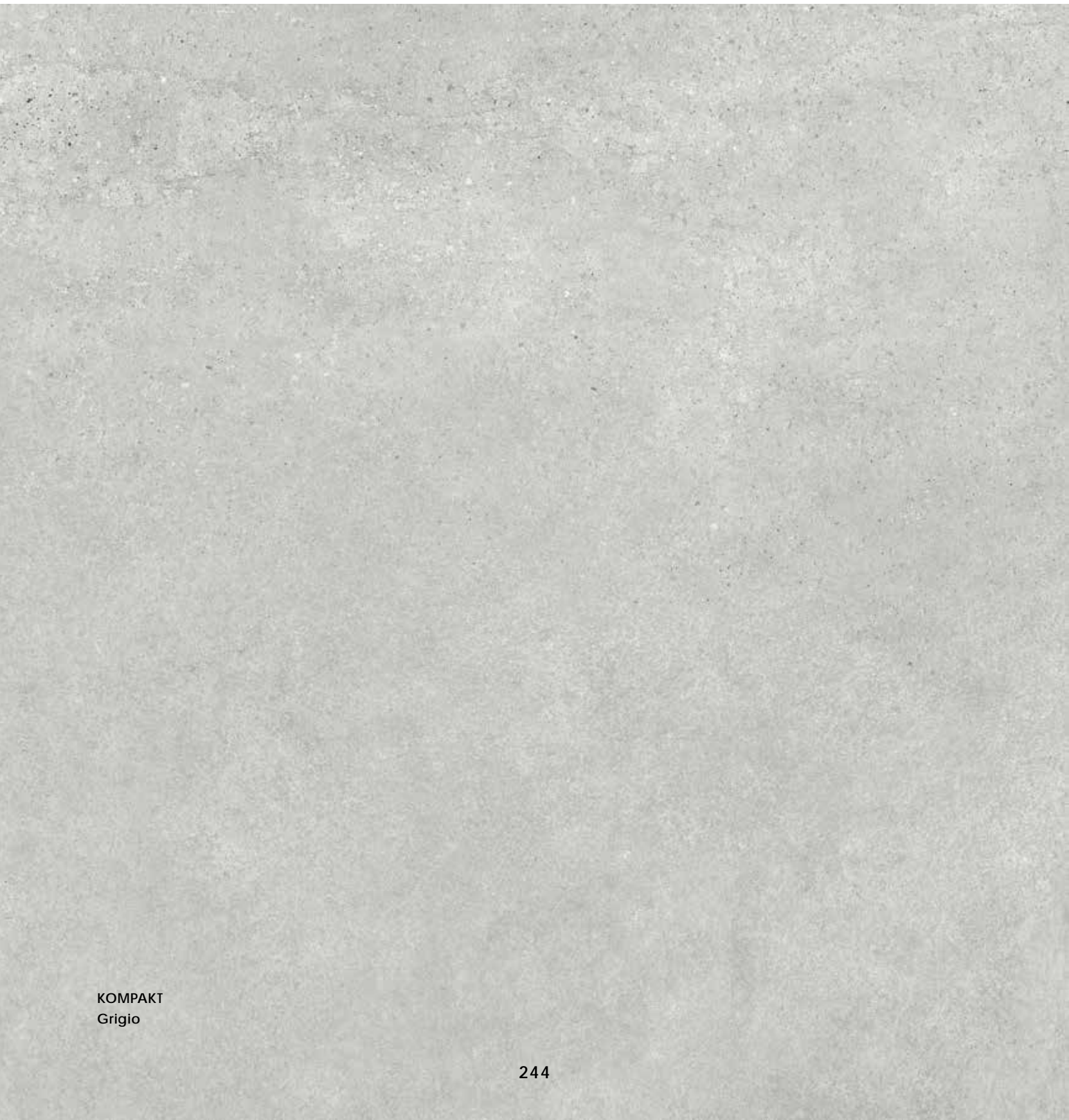

Gres Porcellanato

Porcelained stoneware
Grès cérame
Feinsteinzeug

Spessore / Thickness



9 MM

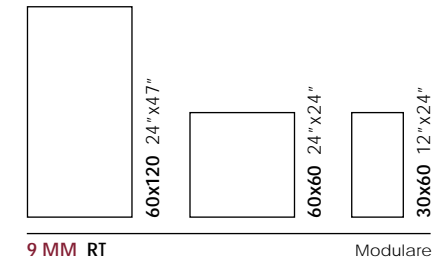

Finiture / Finishes

RT / Rettificato



Bla



V3



fuga
2MM
Rett

Bia GL



Packaging pag. 318





KOMPAKT
Beige 60x60 24"x24" Rett

Kompakt

BIANCO



9 MM
Mosaico NON RETT
30x30 12"x12"
7329495

9 MM

RETT

60x120 24"x47"
8200611

60x60 24"x24"
8200610

30x60 12"x24"
8200612



Battiscopa
RETT
7,5x60 3"x24"
8200613

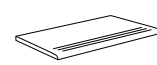

Step
RETT
30x60 12"x24"
8200614

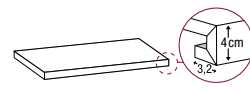

Gradone costa retta
Angolare DX/SX
RETT
33,3x120x4
13"x47"x1,57"
**SU RICHIESTA. ON DEMAND.
SUR DEMANDE. AUF ANFRAGE**

AVORIO



9 MM
Mosaico NON RETT
30x30 12"x12"
7329475

9 MM

RETT

60x120 24"x47"
8200621

60x60 24"x24"
8200620

30x60 12"x24"
8200622



Battiscopa
RETT
7,5x60 3"x24"
8200623

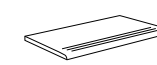

Step
RETT
30x60 12"x24"
8200624

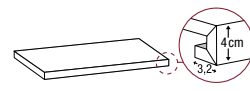

Gradone costa retta
Angolare DX/SX
RETT
33,3x120x4
13"x47"x1,57"
**SU RICHIESTA. ON DEMAND.
SUR DEMANDE. AUF ANFRAGE**

BEIGE



9 MM
Mosaico NON RETT
30x30 12"x12"
7329485

9 MM

RETT

60x120 24"x47"
8200601

60x60 24"x24"
8200600

30x60 12"x24"
8200602



Battiscopa
RETT
7,5x60 3"x24"
8200603

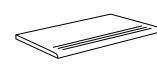

Step
RETT
30x60 12"x24"
8200604

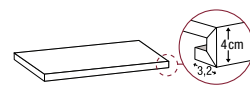

Gradone costa retta
Angolare DX/SX
RETT
33,3x120x4
13"x47"x1,57"
**SU RICHIESTA. ON DEMAND.
SUR DEMANDE. AUF ANFRAGE**

GRIGIO

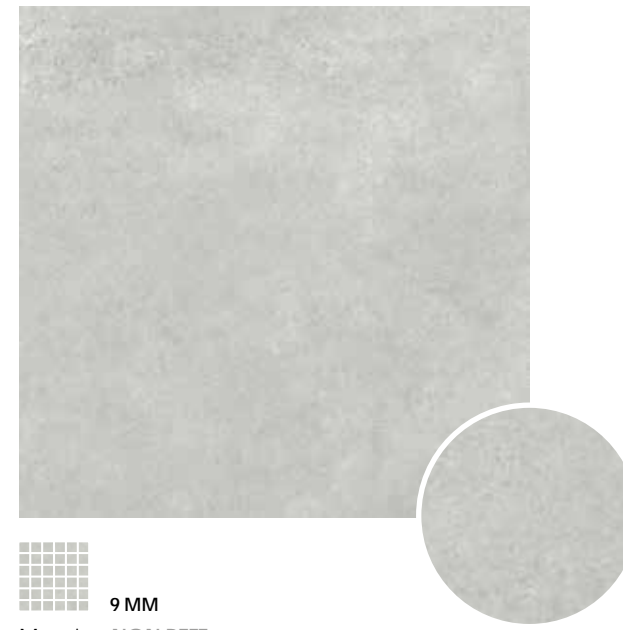

9 MM
Mosaico NON RETT
30x30 12"x12"
7329505

9 MM

RETT

60x120 24"x47"
8200631

60x60 24"x24"
8200630

30x60 12"x24"
8200632



Battiscopa
RETT
7,5x60 3"x24"
8200633

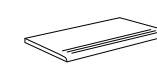

Step
RETT
30x60 12"x24"
8200634

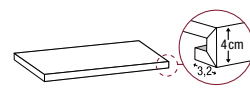

Gradone costa retta
Angolare DX/SX
RETT
33,3x120x4
13"x47"x1,57"
**SU RICHIESTA. ON DEMAND.
SUR DEMANDE. AUF ANFRAGE**

Kompakt

TERRA

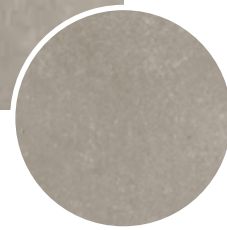

9 MM

Mosaico NON RETT
30x30 12"x12"
7329525

9 MM

RETT

60x120 24"x47"
8200641

60x60 24"x24"
8200640

30x60 12"x24"
8200642



Battiscopa
RETT
7,5x60 3"x24"
8200643

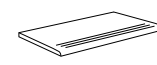

Step
RETT
30x60 12"x24"
8200644

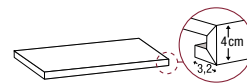

Gradone costa retta
Angolare DX/SX
RETT
33,3x120x4
13"x47"x1,57"
SU RICHIESTA. ON DEMAND.
SUR DEMANDE. AUF ANFRAGE



I CEMENTI

Materika



MATERIKA
Grigio

Gres Porcellanato

Porcelained stoneware
Grès cérame
Feinsteinzeug

Spessore / Thickness



9 MM

Finiture / Finishes

RT / Rettificato

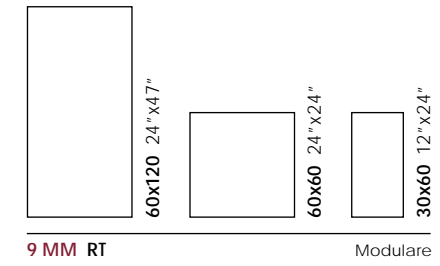

Bla



V3



fuga
2MM
Rett

Bia GL



Packaging pag. 319

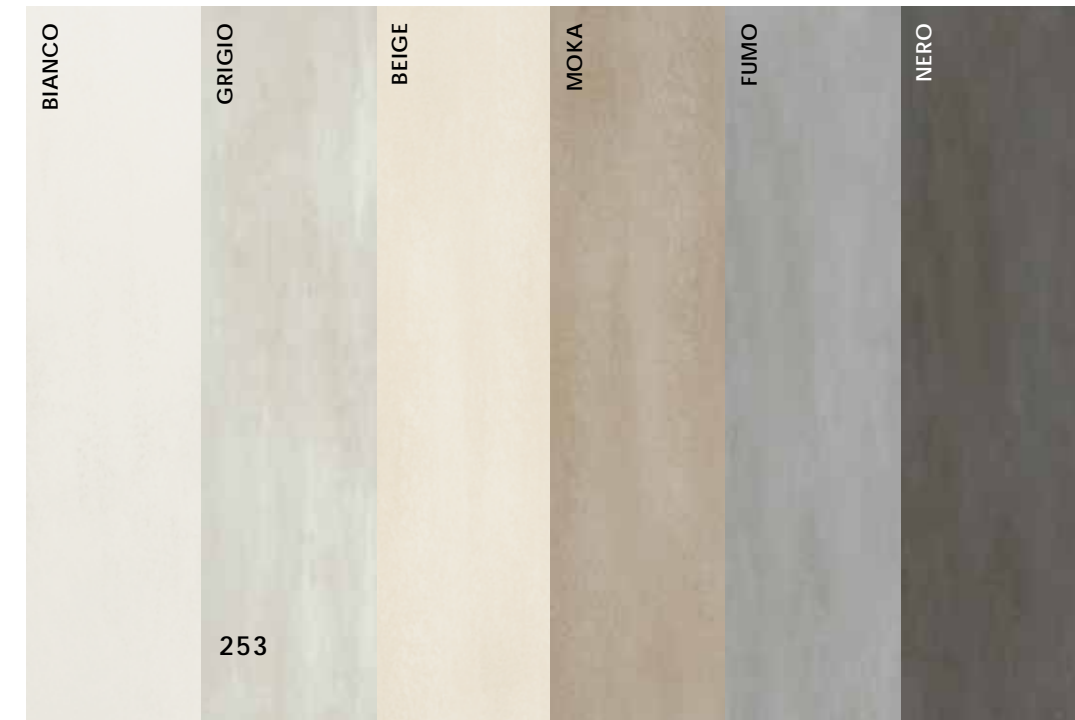



MATERIKA
Grigio 60x60 24"x24" Rett, mosaico 30x30 12"x12"
STONEQUARTZ
Grigio listellato 30x60 12"x24", 60x120x2 24"x47"x0,7" Rett Grip

Materika

BIANCO



9 MM
Mosaico NON RETT
30x30 12"x12"
7278305

9 MM

RETT

60x120 24"x47"
8200661

60x60 24"x24"
8200660

30x60 12"x24"
8200662



Battiscopa
RETT
7,5x60 3"x24"
8200663

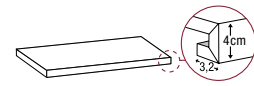

Gradone costa retta
Angolare DX/SX
RETT
33,3x120x4
13"x47"x1,57"
SU RICHIESTA. ON DEMAND.
SUR DEMANDE. AUF ANFRAGE

BEIGE



9 MM
Mosaico NON RETT
30x30 12"x12"
7278335

9 MM

RETT

60x120 24"x47"
8200651

60x60 24"x24"
8200650

30x60 12"x24"
8200652



Battiscopa
RETT
7,5x60 3"x24"
8200653

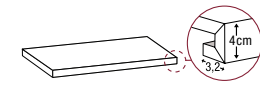

Gradone costa retta
Angolare DX/SX
RETT
33,3x120x4
13"x47"x1,57"
SU RICHIESTA. ON DEMAND.
SUR DEMANDE. AUF ANFRAGE

GRIGIO



9 MM
Mosaico NON RETT
30x30 12"x12"
7278315

9 MM

RETT

60x120 24"x47"
8200671

60x60 24"x24"
8200670

30x60 12"x24"
8200672



Battiscopa
RETT
7,5x60 3"x24"
8200673

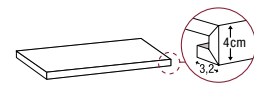

Gradone costa retta
Angolare DX/SX
RETT
33,3x120x4
13"x47"x1,57"
SU RICHIESTA. ON DEMAND.
SUR DEMANDE. AUF ANFRAGE

MOKA



9 MM
Mosaico NON RETT
30x30 12"x12"
7278345

9 MM

RETT

60x120 24"x47"
8200691

60x60 24"x24"
8200690

30x60 12"x24"
8200692



Battiscopa
RETT
7,5x60 3"x24"
8200693

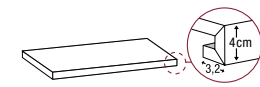

Gradone costa retta
Angolare DX/SX
RETT
33,3x120x4
13"x47"x1,57"
SU RICHIESTA. ON DEMAND.
SUR DEMANDE. AUF ANFRAGE

Materika

FUMO



9 MM

Mosaico NON RETT
30x30 12"x12"
7279711

9 MM

RETT

60x120 24"x47"
8200681

60x60 24"x24"
8200680

30x60 12"x24"
8200682



Battiscopa
RETT
7,5x60 3"x24"
8200683

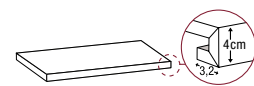

Gradone costa retta
Angolare DX/SX
RETT
33,3x120x4
13"x47"x1,57"
SU RICHIESTA. ON DEMAND.
SUR DEMANDE. AUF ANFRAGE

NERO



9 MM

Mosaico NON RETT
30x30 12"x12"
7278325

9 MM

RETT

60x120 24"x47"
8200701

60x60 24"x24"
8200700

30x60 12"x24"
8200702



Battiscopa
RETT
7,5x60 3"x24"
8200703

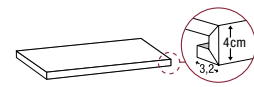

Gradone costa retta
Angolare DX/SX
RETT
33,3x120x4
13"x47"x1,57"
SU RICHIESTA. ON DEMAND.
SUR DEMANDE. AUF ANFRAGE

L.CEMENTI



MATERIKA

Fumo 60x120 24"x47", 60x60 24"x24" Rett

Stucchi



Gres Porcellanato

Porcelained stoneware
Grès cérame
Feinsteinzeug

Spessore / Thickness



10 MM
9 MM

Finiture / Finishes

RT / Rettificato

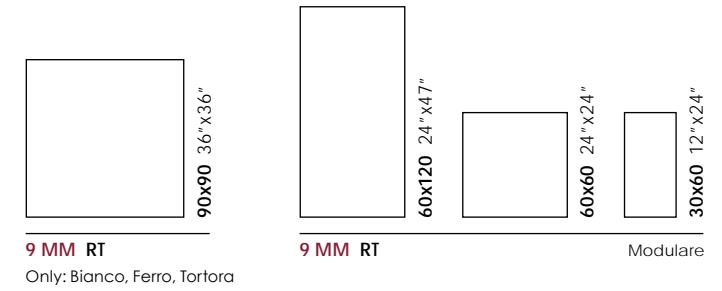

Bla



V2



fuga
2MM
Rett

Bia GL



Packaging pag. 319

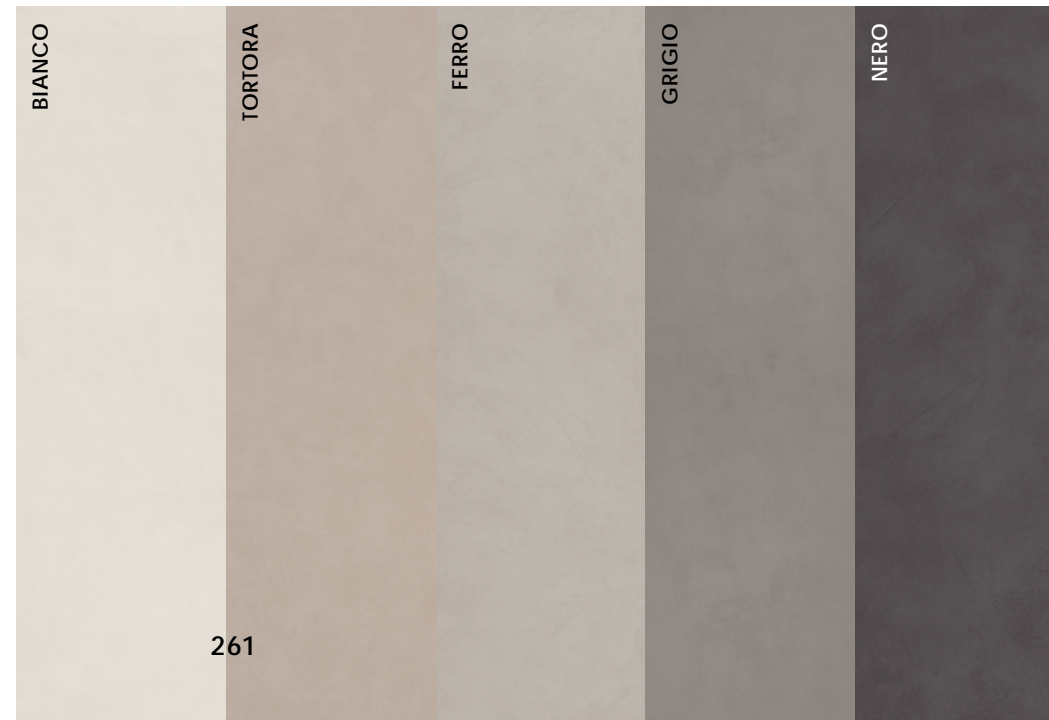





STUCCHI
Ferro 60x120 24"x47" Rett

Stucchi

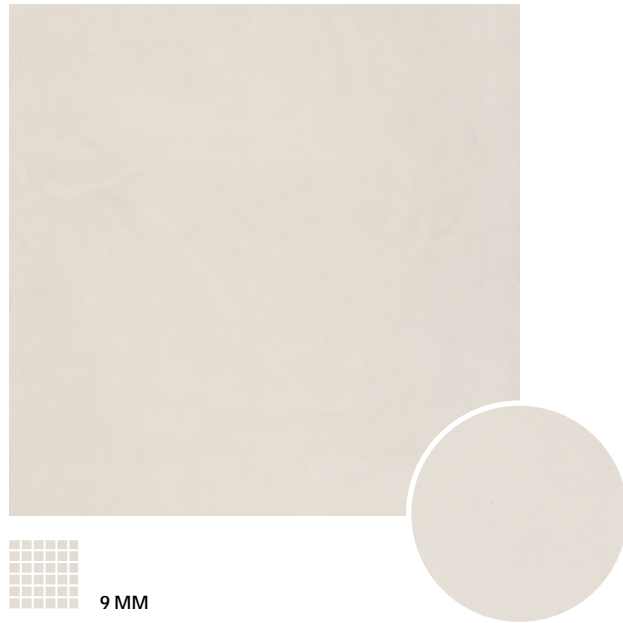
BIANCO



 **9 MM**
Mosaico NON RETT
30x30 12"x12"
7330845

9 MM

RETT

60x120 24"x47"
8200201

60x60 24"x24"
8200200

30x60 12"x24"
8200202

90x90 36"x36"
8350128



Battiscopa
RETT
7,5x60 3"x24"
8200775

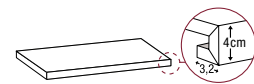

Gradone costa retta
Angolare DX/SX
RETT
33,3x120x4
13"x47"x1,57"
SU RICHIESTA. ON DEMAND.
SUR DEMANDE. AUF ANFRAGE

FERRO

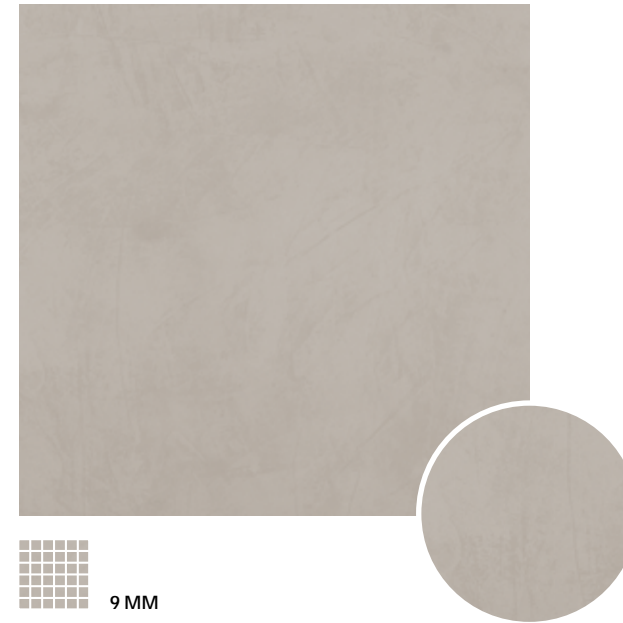

 **9 MM**
Mosaico NON RETT
30x30 12"x12"
7351109

9 MM

RETT

60x120 24"x47"
8200211

60x60 24"x24"
8200210

30x60 12"x24"
8200212

90x90 36"x36"
8351039



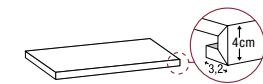

Battiscopa
RETT
7,5x60 3"x24"
8200776

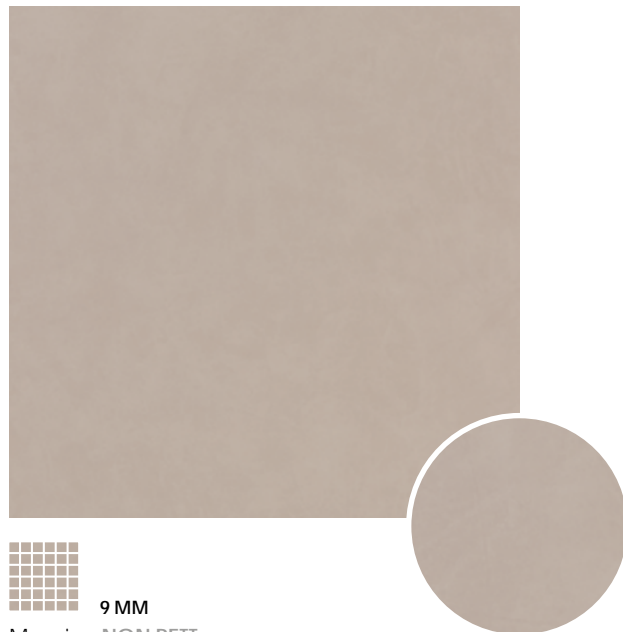

Gradone costa retta
Angolare DX/SX
RETT
33,3x120x4
13"x47"x1,57"
SU RICHIESTA. ON DEMAND.
SUR DEMANDE. AUF ANFRAGE

TORTORA



 **9 MM**
Mosaico NON RETT
30x30 12"x12"
7330855

9 MM

RETT

60x120 24"x47"
8200251

60x60 24"x24"
8200250

30x60 12"x24"
8200252

90x90 36"x36"
8350138



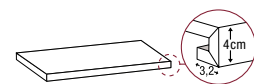

Battiscopa
RETT
7,5x60 3"x24"
8200787

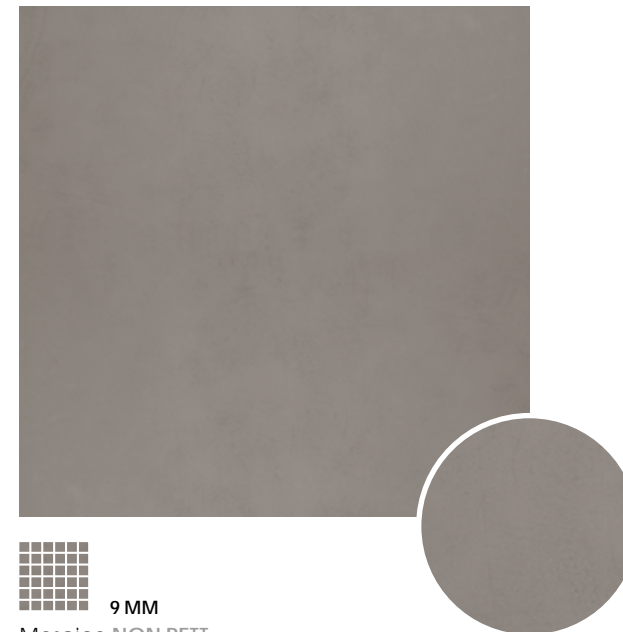

Gradone costa retta
Angolare DX/SX
RETT
33,3x120x4
13"x47"x1,57"
SU RICHIESTA. ON DEMAND.
SUR DEMANDE. AUF ANFRAGE

GRIGIO



 **9 MM**
Mosaico NON RETT
30x30 12"x12"
7330875

9 MM

RETT

60x120 24"x47"
8200231

60x60 24"x24"
8200230

30x60 12"x24"
8200232



Battiscopa
RETT
7,5x60 3"x24"
8200788

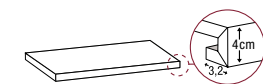

Gradone costa retta
Angolare DX/SX
RETT
33,3x120x4
13"x47"x1,57"
SU RICHIESTA. ON DEMAND.
SUR DEMANDE. AUF ANFRAGE

Stucchi

NERO

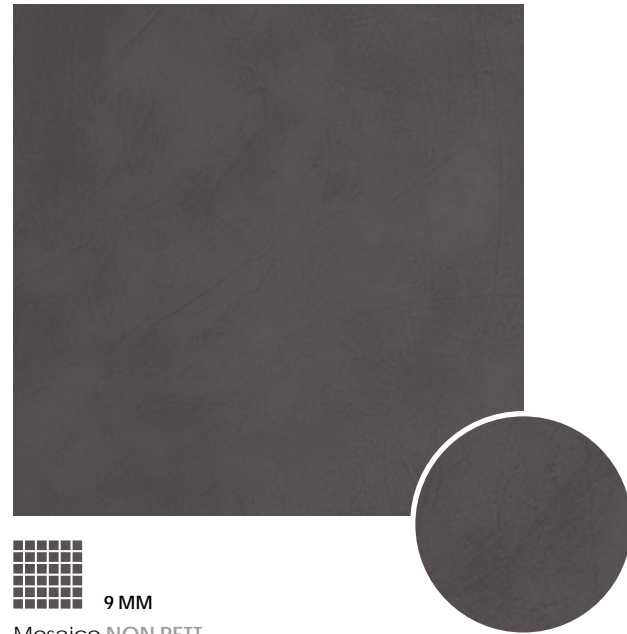

9 MM

Mosaico NON RETT
30x30 12"x12"
7330865

9 MM

RETT

60x120 24"x47"
8200241

60x60 24"x24"
8200240

30x60 12"x24"
8200242



Battiscopa
RETT
7,5x60 3"x24"
8200789

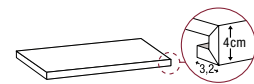

Gradone costa retta
Angolare DX/SX
RETT
33,3x120x4
13"x47"x1,57"
SU RICHIESTA. ON DEMAND.
SUR DEMANDE. AUF ANFRAGE



Venexia



VENEXIA
Cannaregio

Gres Porcellanato

Porcelained stoneware
Grès cérame
Feinsteinzeug

Spessore / Thickness



20 MM
9 MM
6 MM

Finiture / Finishes

RT / Rettificato
NRT / Non Rettificato
RT GR / Rettificato Grip

Su richiesta / On demand

Pezzi speciali 20MM /
Trims 20MM

pag. 338



Bla



V2



fuga
2MM
Rett



fuga
> 3MM
Nat



R11
GRIP



A+B+C
GRIP

Bia GL

CE

Packaging pag. 319

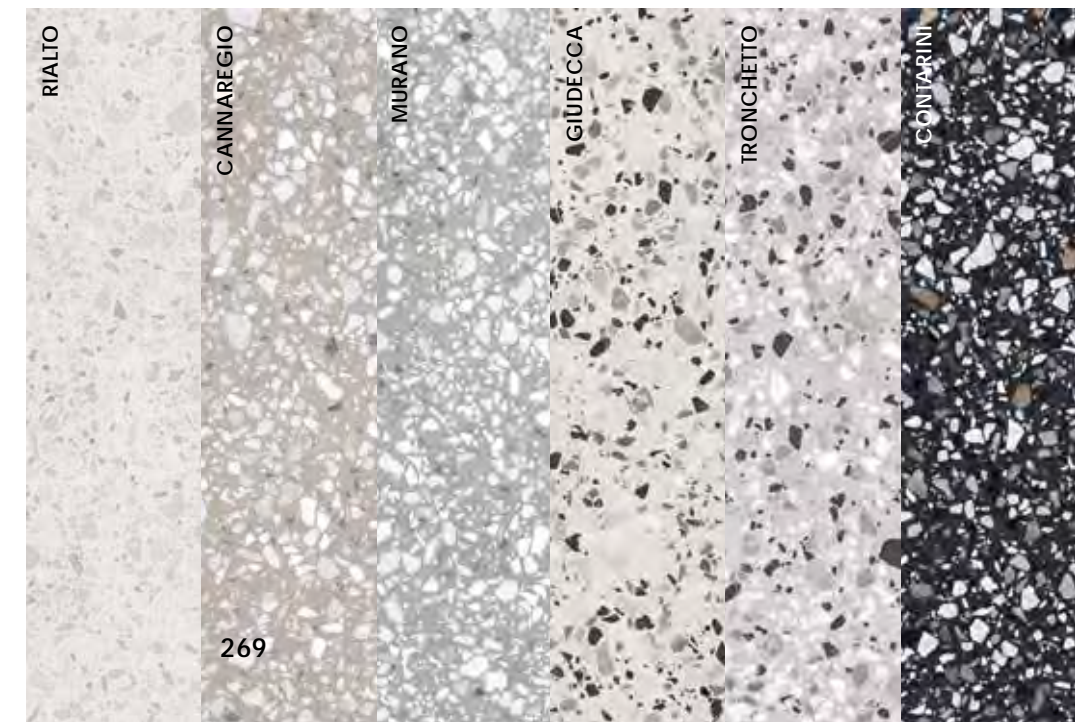
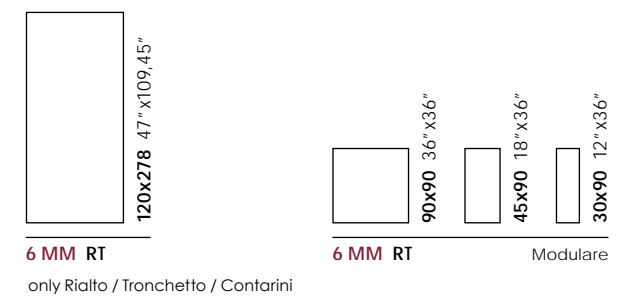
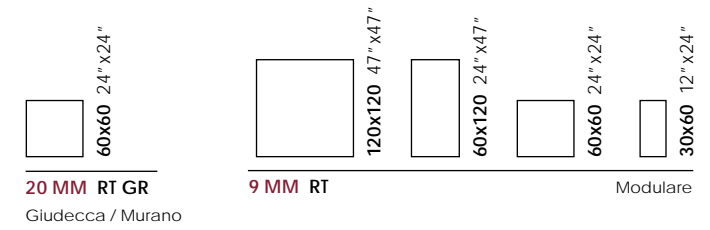



Floor: VENEXIA Murano 90x90 36" x36" Rett
Wall: VIBES Pearl 8,2x25 3,22" x9,84" Matt



VENEXIA
Tronchetto 45X90 18"x36" Rett



Floor: VENEXIA Contarini 90x90 36" x36" Rett
Wall: PASTELLI Opale 90x270 36" x106" Rett Matt

RIALTO



9 MM

RETT

120x120 47"x47"
T200074

60x120 24"x47"
8331247

60x60 24"x24"
8331248

30x60 12"x24"
8331246

GRIP RETT

60x120 24"x47"
8331344

NON RETT

20x20 8"x8"
7270661

6 MM

RETT

120x278 47"x109,45"
T200081

90x90 36"x36"
T202854

45x90 18"x36"
T202857

30x90 12"x36"
T202856



Battiscopa
RETT
7,5x60 3"x24"
8331249

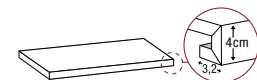

Gradone costa retta
RETT
33,3x120x4
13"x47"x1,57"
8331242

Angolare
DX **8331244**
SX **8331243**

CANNAREGIO



9 MM

RETT

120x120 47"x47"
T200070

60x120 24"x47"
8331207

60x60 24"x24"
8331208

30x60 12"x24"
8331206

NON RETT

20x20 8"x8"
7270621

6 MM

RETT

90x90 36"x36"
T202824

45x90 18"x36"
T202827

30x90 12"x36"
T202826



Battiscopa
RETT
7,5x60 3"x24"
8331209

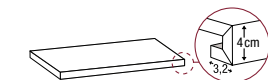

Gradone costa retta
RETT
33,3x120x4
13"x47"x1,57"
8331202

Angolare
DX **8331204**
SX **8331203**

Venexia

MURANO



20 MM

GRIP RETT

60x60 24"x24"
8232375

9 MM

RETT

120x120 47"x47"
T200073

60x120 24"x47"
8331237

60x60 24"x24"
8331238

30x60 12"x24"
8331236

GRIP RETT

60x120 24"x47"
8331336

NON RETT

20x20 8"x8"
7270651



Battiscopa
RETT
7,5x60 3"x24"
8331239

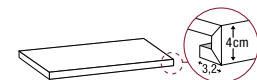

Gradone costa retta
RETT
33,3x120x4
13"x47"x1,57"
8331232

Angolare
DX 8331234
SX 8331233

GIUDECCA

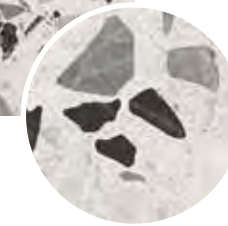
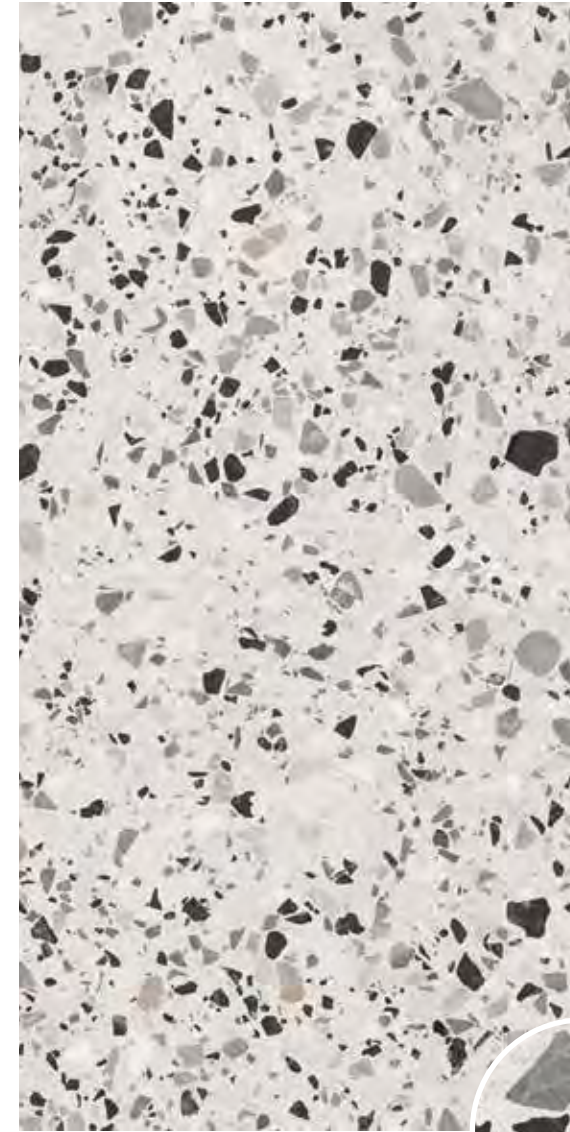

20 MM

GRIP RETT

60x60 24"x24"
8232365

9 MM

RETT

120x120 47"x47"
T200072

60x120 24"x47"
8331227

60x60 24"x24"
8331228

30x60 12"x24"
8331226

GRIP RETT

60x120 24"x47"
8331326

NON RETT

20x20 8"x8"
7270641



Battiscopa
RETT
7,5x60 3"x24"
8331229

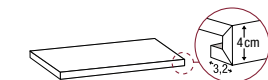

Gradone costa retta
RETT
33,3x120x4
13"x47"x1,57"
8331222

Angolare
DX 8331224
SX 8331223

Venexia

TRONCHETTO



9 MM

RETT

120x120 47"x47"
T200076

60x120 24"x47"
8331257

60x60 24"x24"
8331258

30x60 12"x24"
8331256

GRIP RETT

60x120 24"x47"
8331356

NON RETT

20x20 8"x8"
7270671

6 MM

RETT

120x278 47"x109,45"
T200082

90x90 36"x36"
T202864

45x90 18"x36"
T202867

30x90 12"x36"
T202866



Battiscopa
RETT
7,5x60 3"x24"
8331259

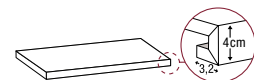

Gradone costa retta
RETT
33,3x120x4
13"x47"x1,57"
8331252

Angolare
DX 8331254
SX 8331253

CONTARINI



9 MM

RETT

120x120 47"x47"
T200071

60x120 24"x47"
8331217

60x60 24"x24"
8331218

30x60 12"x24"
8331216

NON RETT

20x20 8"x8"
7270631

6 MM

RETT

120x278 47"x109,45"
T200080

90x90 36"x36"
T202874

45x90 18"x36"
T202877

30x90 12"x36"
T202876



Battiscopa
RETT
7,5x60 3"x24"
8331219

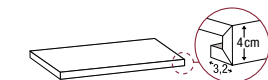

Gradone costa retta
RETT
33,3x120x4
13"x47"x1,57"
8331212

Angolare
DX 8331214
SX 8331213

i Legni

Wood effect
Imitation boi
Holz-Optik

Arbor	282
Badia	292
Wooder	298

Arbor



ARBOR
Rovere

Gres Porcellanato

Porcelained stoneware
Grès cérame
Feinsteinzeug

Spessore / Thickness



20 MM
9 MM

Finiture / Finishes

RT / Rettificato
RT GR / Rettificato Grip

Su richiesta / On demand

Pezzi speciali 20MM /
Trims 20MM

pag. 338

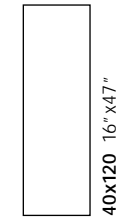

40x120 16" x 47"
20 MM RT GR

Only: Cipresso, Gelso, Rovere

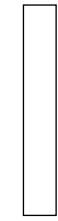

20x120 8" x 47"
9 MM RT / RT GR



Bla



V4



fuga
2MM
Rett



R11
GRIP



A+B+C
GRIP

Bia GL

CE

Packaging pag. 320





ARBOR
Rovere 20x120 8"x47" Rett
PASTELLI
Assenzio 90x270 36"x106" Matt



ARBOR
Gelso 20x120 8"x47" Rett



ARBOR
Cirmolo 20x120 8"x47" Rett

BETULLA



9 MM

RETT GRIP RETT

20x120 8"x47" 20x120 8"x47"
8200488 8200617

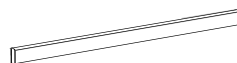

Battiscopa
 RETT
 6,5x120 2,56"x47"
8200674

CARPINO



9 MM

RETT GRIP RETT

20x120 8"x47" 20x120 8"x47"
8200494 8200618



Battiscopa
 RETT
 6,5x120 2,56"x47"
8200675

CIPRESSO



20 MM

GRIP RETT

40x120 16"x47"
8332002

9 MM

RETT GRIP RETT

20x120 8"x47" 20x120 8"x47"
8200497 8200619



Battiscopa
 RETT
 6,5x120 2,56"x47"
8200676

CIRMOLO



9 MM

RETT GRIP RETT

20x120 8"x47" 20x120 8"x47"
8200498 8200625

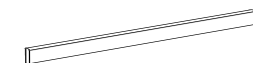

Battiscopa
 RETT
 6,5x120 2,56"x47"
8200677

Arbor

GELSO



20 MM

GRIP RETT

40x120 16"x47"
8332000

9 MM

RETT

20x120 8"x47"
8200499

GRIP RETT

20x120 8"x47"
8200626

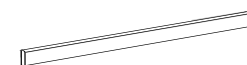

Battiscopa
RETT
6,5x120 2,56"x47"
8200678

ROVERE



20 MM

GRIP RETT

40x120 16"x47"
8332001

9 MM

RETT

20x120 8"x47"
8200503

GRIP RETT

20x120 8"x47"
8200627



Battiscopa
RETT
6,5x120 2,56"x47"
8200679



Badia



BADIA
Frassino

Gres Porcellanato

Porcelained stoneware
Grès cérame
Feinsteinzeug

Spessore / Thickness



20 MM
9 MM

Finiture / Finishes

RT / Rettificato
RT RC / Rettificato ROC

Su richiesta / On demand

Pezzi speciali 20MM /
Trims 20MM

pag. 338

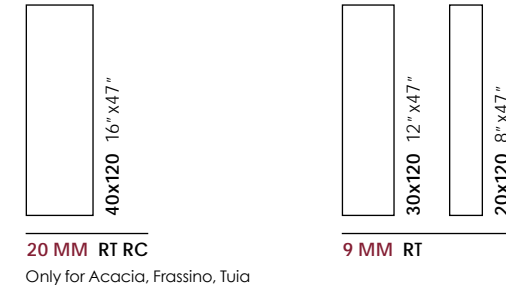

Bla



V4



fuga
2MM
Rett



R11
ROC



A+B+C
ROC

Bia GL

CE

Packaging pag. 320





BADIA
Acacia 40x120x2 16"x47"x0,7" Rett Roc



BADIA
Frassino 20x120 8"x47", 30x120 12"x47" Rett

Badia

ACACIA



20 MM **9 MM**

ROC RETT RETT

40x120 16"x47"
8333015 30x120 12"x47"
8200185

20x120 8"x47"
8200175



Battiscopa
RETT
7,5x120 3"x47"
8200196

CASTAGNO



9 MM

RETT

30x120 12"x47"
8200187

20x120 8"x47"
8200177



Battiscopa
RETT
7,5x120 3"x47"
8200198

FRASSINO



20 MM **9 MM**

ROC RETT RETT

40x120 16"x47"
8333045 30x120 12"x47"
8200188

20x120 8"x47"
8200178

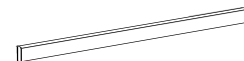

Battiscopa
RETT
7,5x120 3"x47"
8200194

ACERO



9 MM

RETT

30x120 12"x47"
8200186

20x120 8"x47"
8200176

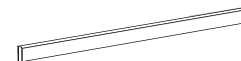

Battiscopa
RETT
7,5x120 3"x47"
8200197

TUIA



20 MM **9 MM**

ROC RETT RETT

40x120 16"x47"
8333025 30x120 12"x47"
8200189

20x120 8"x47"
8200179



Battiscopa
RETT
7,5x120 3"x47"
8200193

Wooder



WOODER
Clove

Gres Porcellanato

Porcelained stoneware
Grès cérame
Feinsteinzeug

Spessore / Thickness



20 MM
9 MM

Finiture / Finishes

RT / Rettificato
RT GR / Rettificato Grip

Su richiesta / On demand

Pezzi speciali 20MM /
Trims 20MM

pag. 338



Bla



V4



fuga
2MM
Rett



R11
GRIP



A+B+C
GRIP

Bia GL

CE

Packaging pag. 320

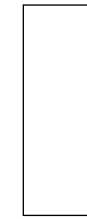

40x120 16" x 47"

20 MM RT GR

Only for Clove, Lime, Maple



20x120 8" x 47"

9 MM RT / RT GR

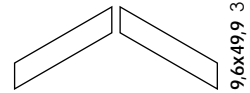

9,6x49,9 3,78" x 19,64"

9 MM RT





Outdoor: **WOODER Maple 20x120 8"x47"** Rett Grip
Indoor: **WOODER Maple chevron 9,6x49,9 3,78"x19,64"** Rett



WOODER
Lime 20x120 8"x47" Rett

Wooder

ASH



9 MM

RETT	GRIP RETT
20x120 8"x47"	20x120 8"x47"
8200151	8200153



Chevron
RETT
9,6x49,9 3,78"x19,64"
8200154

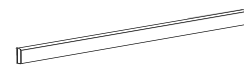

Battiscopa
RETT
6,5x120 2,56"x47"
8200244

MAPLE



20 MM

GRIP RETT
40x120 16"x47"
8200243



Chevron
RETT
9,6x49,9 3,78"x19,64"
8200328

9 MM

RETT	GRIP RETT
20x120 8"x47"	20x120 8"x47"
8200158	8200214



Battiscopa
RETT
6,5x120 2,56"x47"
8200254

IROKO



9 MM

RETT	GRIP RETT
20x120 8"x47"	20x120 8"x47"
8200164	8200204



Chevron
RETT
9,6x49,9 3,78"x19,64"
8200323



Battiscopa
RETT
6,5x120 2,56"x47"
8200248

LIME



20 MM

GRIP RETT
40x120 16"x47"
8200234

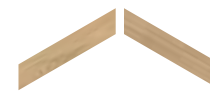

Chevron
RETT
9,6x49,9 3,78"x19,64"
8200324

9 MM

RETT	GRIP RETT
20x120 8"x47"	20x120 8"x47"
8200168	8200208

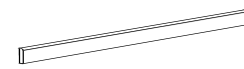

Battiscopa
RETT
6,5x120 2,56"x47"
8200253

Wooder

CLOVE



20 MM

GRIP RETT

40x120 16"x47"
8200223

9 MM

RETT

20x120 8"x47"
8200147

GRIP RETT

20x120 8"x47"
8200218

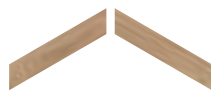

Chevron
RETT
9,6x49,9 3,78"x19,64"
8200148

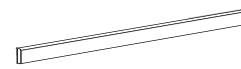

Battiscopa
RETT
6,5x120 2,56"x47"
8200247



WOODER
Clove 20x120 8"x47" Rett, Clove Chevron 9,6x49,9 3,78"x19,64" Rett

Info tecniche

Technical info / Informations Techniques / Technische Information







Pesi e imballi

Weights and packaging / Poids et emballage / Gewichte und Verpackungen

LE TINTE / Paint effect / Imitation couleur / Farboptik







PASTELLI

Pag. 32

		tipologia imballo packaging		M ² 	Kg 		M ² 	Kg 
90x270 36"x106"	6	cassa / crate 106x290x28 (vuoto/empty: 108 kg [Ⓐ])	1	2,43	[Ⓑ] 38	22	53,46	944,00*
90x90 36"x36"	6	pallet con sponda 94x124	3	2,43	-	26	63,18	988,00
45x90 18"x36"	6	pallet 94x124	5	2,02	-	30	60,75	912,00
30x90 12"x36"	6	pallet 100x120	6	1,62	-	30	48,60	747,00
30x30 12"x12" MOSAICO	6	-	11	1,00	-	30	30,00	390,00
30x30 12"x12" MURETTO	6	-	11	1,00	-	30	30,00	390,00
90x270 36"x106" TIARÉ	6	cassa / crate 106x290x28 (vuoto/empty: 108 kg [Ⓐ])	1	2,43	[Ⓑ] 38	22	53,46	944,00*

VIBES







Pag. 46

			M ² 		M ² 	Kg 
8,2x25 3,22"x 9,84"	9	28	0,57	78	44,46	924,30

LE PIETRE / Stone effect / Imitation pierre / Steineffekt

ATLANTIS

Pag. 54

			M ² 		M ² 	Kg 
60x120x2 24"x47"x0,7"	20	1	0,72	36	25,92	1.188,00
60x60x2 24"x24"x0,7"	20	2	0,72	32	23,04	1.056,00
120x120 47"x47"	9	2	2,88	18	51,84	1.088,64
60x120 24"x47"	9	2	1,44	36	51,84	1.026,00
60x60 24"x24"	9	3	1,08	40	43,20	860,00
30x60 12"x24"	9	7	1,26	40	50,40	960,00
20x40 8"x16"	8	18	1,44	56	80,64	1.330,56
20x20 8"x8"	8	30	1,20	68	81,60	1.346,40
15x15 6"x6"	8	46	1,04	75	78,00	1.200,00
30x30 12"x12" MOSAICO	9	11	1,00	30	30,00	603,00
27,4x31,7 10,78"x12,48" ESAGONI	-	5	0,43	84	-	882,00
7,5x60 3"x24" BATTISCOPA	-	14	-	40	-	498,40
4x15x30 1,57"x6"x12" EL. L. PRESSA	-	8	-	44	-	415,36

* Peso riferito a cassa completa. Per acquisti di lastre a cassa incompleta parziale sommare peso cassa/cavalletto [Ⓐ] e peso lastre [Ⓑ]

Weight for complete crate. For order less than a full crate you need to add together the weight of the empty crate [Ⓐ] plus the weight of each slab [Ⓑ]







Poids à la caisse complète. Pour les achats de dalles avec caisse incomplète ou partielle, sommer le poids de la caisse/chevalet [Ⓐ] et du poids de la dalle [Ⓑ]

Gewicht einer vollen Kiste. Fuer Kommissionen bitte Kisten [Ⓐ] und Materialgewicht [Ⓑ] addieren.

LE PIETRE / Stone effect / Imitation pierre / Steineffekt







BLENDSTONE

Pag. 68

			M ² 		M ² 	Kg 
60x120x2 24"x47"x0,7"	20	1	0,72	36	25,92	1.188,00
60x60x2 24"x24"x0,7"	20	2	0,72	32	23,04	1.056,00
120x120 47"x47"	9	2	2,88	18	51,84	1.088,64
60x120 24"x47"	9	2	1,44	36	51,84	1.026,00
60x60 24"x24"	9	3	1,08	40	43,20	860,00
30x60 12"x24" rett.	9	7	1,26	40	50,40	960,00
30x60 12"x24" non rett.	9	7	1,26	40	50,40	980,00
20x40 8"x16"	8	18	1,44	56	80,64	1.330,56
20x20 8"x8"	8	30	1,20	68	81,60	1.346,40
27,4x31,7 10,78"x12,48" ESAGONI	-	5	0,43	84	-	882,00
7,5x60 3"x24" BATTISCOPA	-	14	-	40	-	498,40
4x15x30 1,57"x6"x12" EL. L. PRESSA	-	8	-	44	-	415,36

COTTAGE

Pag. 84







			M ² 		M ² 	Kg 
60x120x2 24"x47"x0,7"	20	1	0,72	36	25,92	1.188,00
60x60x2 24"x24"x0,7"	20	2	0,72	32	23,04	1.056,00
modulo 60x120 60x90 30x60	9	1	1,44	36	51,84	1.170,00
90x90 36"x36"	9	2	1,62	27	43,74	985,50
45x90 18"x36"	9	3	1,21	36	43,74	990,00
60x120 24"x47"	9	2	1,44	36	51,84	1.026,00
60x60 24"x24"	9	3	1,08	40	43,20	886,00
30x60 12"x24" rett.	9	7	1,26	40	50,40	1.040,00
30x60 12"x24" non rett.	9	7	1,26	40	50,40	980,00
7,5x60 3"x24" BATTISCOPA	-	14	-	40	-	498,40
30x60 12"x24" STEP	-	7	-	36	-	1.008,00
33,3x120 13"x47"x1,57" GRADONE	-	2	-	20	-	328,00
33,3x120 13"x47"x1,57" ANGOLARE	-	2	-	20	-	328,00

Pesi e imballi / Weights and packaging / Poids et emballage / Gewichte und Verpackungen

LE PIETRE / Stone effect / Imitation pierre / Steineffekt







HILLS

Pag. 96

						
			M ²		M ²	Kg
60x120 24"x47"	9	2	1,44	36	51,84	1.026,00
60x60 24"x24"	9	3	1,08	40	43,20	860,00
30x60 12"x24"	9	7	1,26	40	50,40	960,00
30x30 12"x12" MOSAICO	9	11	1,00	30	30,00	603,00
7,5x60 3"x24" BATTISCOPA	-	14	-	40	-	498,40
4x15x30 1,57"x6"x12" EL. L. PRESSA	-	8	-	44	-	415,36







LATHEMAR

Pag. 104

						
			M ²		M ²	Kg
30x30 12"x12"	8	13	1,17	48	56,16	960,00
15x30 6"x12"	8	23	1,04	75	78,00	1.200,00
15x15 6"x6" spigolo vivo	8	46	1,04	75	78,00	1.200,00
7,5x30 3"x12" BATTISCOPA	-	32	-	72	-	864,00
30x30 12"x12" STEP	-	15	-	40	-	939,99
4x15x30 1,57"x6"x12" EL. L. PRESSA	-	8	-	44	-	415,36

NEUTRA ROC







Pag. 112

						
			M ²		M ²	Kg
60x60x2 24"x24"x0,7"	20	2	0,72	32	23,04	1.056,00

LE PIETRE / Stone effect / Imitation pierre / Steineffekt







PANGEA

Pag. 116

		tipologia imballo packaging						
			M ²	Kg		M ²	Kg	
60x120x2 24"x47"x0,7"	20	-	1	0,72	-	36	25,92	1.188,00
60x60x2 24"x24"x0,7"	20	-	2	0,72	-	32	23,04	1.056,00
120x120 47"x47"	9	-	2	2,88	-	18	51,84	1.088,64
60x120 24"x47"	9	-	2	1,44	-	36	51,84	1.026,00
60x60 24"x24"	9	-	3	1,08	-	40	43,20	860,00
30x60 12"x24" rett.	9	-	7	1,26	-	40	50,40	960,00
30x60 12"x24" non rett.	9	-	7	1,26	-	40	50,40	980,00
90x270 36"x106" TIARÉ	6	cassa / crate 106x290x28 (vuoto/empty: 108 kg [Ⓐ])	1	2,43	Ⓑ 38	22	53,46	944,00*
27,4x31,7 10,78"x12,48" ESAGONI	-	-	5	0,43	-	84	-	882,00
36,1x57,6 14,21"x22,67" LOSANGA	-	-	7	0,966	-	18	-	414,00
7,5x60 3"x24" BATTISCOPA	-	-	14	-	-	40	-	498,40
4x15x30 1,57"x6"x12" EL. L. PRESSA	-	-	8	-	-	44	-	415,36

PIETRE PURE

Pag. 130

						
			M ²		M ²	Kg
60x60x2 24"x24"x0,7"	20	2	0,72	32	23,04	1.056,00
60x120 24"x47"	9	2	1,44	36	51,84	1.026,00
60x60 24"x24"	9	3	1,08	40	43,20	860,00
30x60 12"x24" rett.	9	7	1,26	40	50,40	960,00
30x60 12"x24" non rett.	9	7	1,26	40	50,40	960,00
29,7x59,5 12"x24"	9	7	1,24	40	49,60	950,00
20x40 8"x16"	8	18	1,44	56	80,64	1.330,56
20x20 8"x8"	8	30	1,20	68	81,60	1.346,40
30x30 12"x12" MOSAICO	9	11	1,00	30	30,00	570,00
30x60 12"x24" LISTELLATO	9	4	0,70	30	21,00	447,00
7,5x60 3"x24" BATTISCOPA	-	14	-	40	-	498,40
30x60 12"x24" STEP	-	7	-	36	-	1.008,00
4x15x30 1,57"x6"x12" EL. L. PRESSA	-	8	-	44	-	415,36
33,3x120 13"x47"x1,57" GRADONE	-	2	-	20	-	328,00
33,3x120 13"x47"x1,57" ANGOLARE	-	2	-	20	-	328,00

* Peso riferito a cassa completa. Per acquisti di lastre a cassa incompleta parziale sommare peso cassa/cavalletto [Ⓐ] e peso lastre [Ⓑ]
 Weight for complete crate. For order less than a full crate you need to add together the weight of the empty crate [Ⓐ] plus the weight of each slab [Ⓑ]
 Poids à la caisse complète. Pour les achats de dalles avec caisse incomplète ou partielle, sommer le poids de la caisse/chevalet [Ⓐ] et du poids de la dalle [Ⓑ]
 Gewicht einer vollen Kiste. Fuer Kommissionen bitte Kisten [Ⓐ] und Materialgewicht [Ⓑ] addieren.

Pesi e imballi / Weights and packaging / Poids et emballage / Gewichte und Verpackungen

LE PIETRE / Stone effect / Imitation pierre / Steineffekt

STONEQUARTZ

Pag. 142

			M ²		M ²	Kg
60x120x2 24"x47"x0,7"	20	1	0,72	36	25,92	1.188,00
60x60x2 24"x24"x0,7"	20	2	0,72	32	23,04	1.056,00
modulo 60x120 60x90 30x60	9	1	1,44	36	51,84	1.170,00
modulo vintage 60x60 40x40 40x20 20x20	9	2	1,44	32	46,08	918,40
60x120 24"x47"	9	2	1,44	36	51,84	1.026,00
60x60 24"x24"	9	3	1,08	40	43,20	860,00
30x60 12"x24" rett.	9	7	1,26	40	50,40	960,00
45x90 18"x36"	9	3	1,215	36	43,74	990,00
30x60 12"x24" non rett.	9	7	1,26	40	50,40	980,00
30x30 12"x12"	8	13	1,17	48	56,16	906,24
20x40 8"x16"	8	18	1,44	56	80,64	1.330,56
20x20 8"x8"	8	30	1,20	68	81,60	1.346,40
15x15 6"x6"	8	46	1,04	75	78,00	1.200,00
30x30 12"x12" MOSAICO	9	11	1,00	30	30,00	603,00
30x60 12"x24" LISTELLATO	9	4	0,70	30	21,00	447,00
53,5x103 21,06"x40,35" PAVÈ	-	2	0,72	15	10,80	375,00
7,5x60 3"x24" BATTISCOPIA	-	14	-	40	-	498,40
30x30 12"x12" STEP	-	11	-	40	-	803,99
4x15x30 1,57"x6"x12" EL. L. PRESSA	-	8	-	44	-	415,36
33,3x120 13"x47"x1,57" GRADONE	-	2	-	20	-	328,00
33,3x120 13"x47"x1,57" ANGOLARE	-	2	-	20	-	328,00

I MARMI / Marble effect / Imitation marbre / Marmor-Optik

CANOVA

Pag. 160

		tipologia imballo packaging		M ²	Kg		M ²	Kg
160x320 63"x126" (*)	12	cavalletto / A-frame 75x330x194h (vuoto/empty: 193 kg [Ⓐ])	1	5,12	Ⓑ 150	20	102,4	3.193,00*
		cassa / crate 179x347x38 (vuoto/empty: 163 kg [Ⓐ])	1	5,12	Ⓑ 150	9	46,08	1.513,00*
120x278 47"x109,45" (*)	6	cassa / crate 138x291x42 (vuoto/empty: 141 kg [Ⓐ])	1	3,34	Ⓑ 49,63	20	66,80	1.133,00*
120x278 BOOKMATCH	6	cassa / crate 138x291x42 (vuoto/empty: 141 kg [Ⓐ])	1	3,34	Ⓑ 49,63	20	66,80	1.133,00*
90x270 36"x106" (*)	6	cassa / crate 106x290x28 (vuoto/empty: 108 kg [Ⓐ])	1	2,43	Ⓑ 38	22	53,46	944,00*
90x270 RUNNING VEIN	6	cassa / crate 106x290x28 (vuoto/empty: 108 kg [Ⓐ])	1	2,43	Ⓑ 38	22	53,46	944,00*
120x120 47"x47"	6	pallet con sponda 123x143	2	2,88	42,53	24	69,12	1.020,72
60x120 24"x47"	6	pallet 95x122	3	2,16	31,90	36	77,76	1.148,40
90x90 36"x36"	6	pallet con sponda 94x124	3	2,43	38	26	63,18	988,00
45x90 18"x36"	6	pallet 94x124	5	2,025	30,40	30	60,75	912,00
30x90 12"x36"	6	pallet 100x120	6	1,62	24,90	30	48,60	747,00
7,5x90 3"x36" BATTISCOPIA	6	-	5	-	-	55	-	288,75
90x90 36"x36"	9	-	2	1,62	-	27	43,74	985,50
60x120 24"x47"	9	-	2	1,44	-	36	51,84	1.026,00
60x60 24"x24"	9	-	3	1,08	-	40	43,20	886,00
30x60 12"x24"	9	-	7	1,26	-	40	50,40	1.040,00
30x30 12"x12" MOSAICO	9	-	11	1,00	-	30	30,00	603,00
30x30 12"x12" MOS. SHINE	9	-	11	1,00	-	30	30,00	630,00
30x30 12"x12" MOS. GLAM	9	-	11	1,00	-	30	30,00	630,00
4x29,5 1,6"x11,61" REAL MARBLE LONDON	-	-	10	0,11	-	20	2,33	50,00
7,5x60 3"x24" BATTISCOPIA	-	-	14	-	-	40	-	498,40
30x60 12"x24" STEP	-	-	7	-	-	36	-	1.008,00
33,3x120 13"x47"x1,57" GRADONE	-	-	2	-	-	20	-	328,00
33,3x120 13"x47"x1,57" ANGOLARE	-	-	2	-	-	20	-	328,00

(*) Stuoia in fibra di vetro nel retropiastrella disponibile a richiesta

(*) Fiber glass back available on demand







* Peso riferito a cassa completa. Per acquisti di lastre a cassa incompleta parziale sommare peso cassa/cavalletto [Ⓐ] e peso lastre [Ⓑ]Weight for complete crate. For order less than a full crate you need to add together the weight of the empty crate [Ⓐ] plus the weight of each slab [Ⓑ]Poids à la caisse complète. Pour les achats de dalles avec caisse incomplète ou partielle, sommer le poids de la caisse/chevalet [Ⓐ] et du poids de la dalle [Ⓑ]Gewicht einer vollen Kiste. Für Kommissionen bitte Kisten [Ⓐ] und Materialgewicht [Ⓑ] addieren.

Pesi e imballi / Weights and packaging / Poids et emballage / Gewichte und Verpackungen

I MARMI / Marble effect / Imitation marbre / Marmor-Optik







MARVILLA

Pag. 180

		tipologia imballo packaging		M ² 	Kg 		M ² 	Kg 
90x270 36"x106"	6	cassa / crate 106x290x28 (vuoto/empty: 108 kg [Ⓐ])	1	2,43	[Ⓑ] 38	22	53,46	944,00*
120x120 47"x47"	9	pallet con sponda 123x143	2	2,88	68	18	51,84	1.088,64
60x120 24"x47"	9	-	2	1,44	-	36	51,84	1.026,00
60x60 24"x24"	9	-	3	1,08	-	40	43,20	886,00
30x60 12"x24"	9	-	7	1,26	-	40	50,40	1.040,00
36,1x57,6 14,21"x22,67" LOSANGA	-	-	7	0,966	-	18	-	414,00
30x30 12"x12" MOSAICO	9	-	11	1,00	19	30	30,00	570,00
7,5x60 3"x24" BATTISCOPIA	-	-	14	-	-	40	-	498,40
33,3x120 13"x47"x1,57" GRADONE	-	-	2	-	-	20	-	328,00
33,3x120 13"x47"x1,57" ANGOLARE	-	-	2	-	-	20	-	328,00

PALATINA

Pag. 196







			M ² 		M ² 	Kg 
60x120 24"x47"	9	2	1,44	36	51,84	1.098,00
60x60 24"x24"	9	3	1,08	40	43,20	886,00
30x60 12"x24"	9	7	1,26	40	50,40	1.040,00
30x30 12"x12" MOSAICO	9	11	1,00	30	30,00	570,00
7,5x60 3"x24" BATTISCOPIA	-	14	-	40	-	498,40

* Peso riferito a cassa completa. Per acquisti di lastre a cassa incompleta parziale sommare peso cassa/cavallo [Ⓐ] e peso lastre [Ⓑ]
 Weight for complete crate. For order less than a full crate you need to add together the weight of the empty crate [Ⓐ] plus the weight of each slab [Ⓑ]
 Poids à la caisse complète. Pour les achats de dalles avec caisse incomplète ou partielle, sommer le poids de la caisse/chevalet [Ⓐ] et du poids de la dalle [Ⓑ]
 Gewicht einer vollen Kiste. Für Kommissionen bitte Kisten [Ⓐ] und Materialgewicht [Ⓑ] addieren.

I CEMENTI / Concrete effect / Cotto Imitation ciments / Beton-Optik

CEMENTART







Pag. 206

		tipologia imballo packaging		M ² 	Kg 		M ² 	Kg 
60x120x2 24"x47"x0,7"	20	-	1	0,72	-	36	25,92	1.188,00
60x60x2 24"x24"x0,7"	20	-	2	0,72	-	32	23,04	1.056,00
120x278 47"x109,45" (*)	6	cassa / crate 138x291x42 (vuoto/empty: 141 kg [Ⓐ])	1	3,34	[Ⓑ] 49,63	20	66,80	1.133,00*
120x120 47"x47"	6	pallet con sponda 123x143	2	2,88	42,53	24	69,12	1.020,72
60x120 24"x47"	6	pallet 95x122	3	2,16	31,90	36	77,76	1.148,40
60x120 24"x47"	9	-	2	1,44	-	36	51,84	1.026,00
60x60 24"x24"	9	-	3	1,08	-	40	43,20	886,00
30x60 12"x24" rett.	9	-	7	1,26	-	40	50,40	960,00
30x60 12"x24" non rett.	9	-	7	1,26	-	40	50,40	980,00
27,4x31,7 10,78"x12,48" ESAGONI	-	-	5	0,43	-	84	-	882,00
36,1x57,6 14,21"x22,67" LOSANGA	-	-	7	0,966	-	18	-	414,00
7,5x60 3"x24" BATTISCOPIA	-	-	14	-	-	40	-	498,40
4x15x30 1,57"x6"x12" EL. L. PRESSA	-	-	8	-	-	44	-	415,36

(*) Stuoia in fibra di vetro nel retropiastrella disponibile a richiesta
 (*) Fiber glass back available on demand

CROSSOVER

Pag. 222

			M ² 		M ² 	Kg 
90x90 36"x36"	9	2	1,62	27	43,74	985,50
60x120 24"x47"	9	2	1,44	36	51,84	1.026,00
60x60 24"x24"	9	3	1,08	40	43,20	886,00
30x60 12"x24"	9	7	1,26	40	50,40	960,00
30x30 12"x12" MOSAICO	9	11	1,00	30	30,00	570,00
7,5x60 3"x24" BATTISCOPIA	-	14	-	40	-	498,40
30x60 12"x24" STEP	-	7	-	36	-	1.008,00







* Peso riferito a cassa completa. Per acquisti di lastre a cassa incompleta parziale sommare peso cassa/cavallo [Ⓐ] e peso lastre [Ⓑ]
 Weight for complete crate. For order less than a full crate you need to add together the weight of the empty crate [Ⓐ] plus the weight of each slab [Ⓑ]
 Poids à la caisse complète. Pour les achats de dalles avec caisse incomplète ou partielle, sommer le poids de la caisse/chevalet [Ⓐ] et du poids de la dalle [Ⓑ]
 Gewicht einer vollen Kiste. Für Kommissionen bitte Kisten [Ⓐ] und Materialgewicht [Ⓑ] addieren.

Pesi e imballi / Weights and packaging / Poids et emballage / Gewichte und Verpackungen

I CEMENTI / Concrete effect / Cotto Imitation ciments / Beton-Optik







GARDA

Pag. 232

		tipologia imballo packaging		M ² 	Kg 		M ² 	Kg 
90x270 36"x106"	6	cassa / crate 106x290x28 (vuoto/empty: 108 kg [Ⓐ])	1	2,43	Ⓑ 38	22	53,46	944,00*
90x90 36"x36"	6	pallet con sponda 94x124	3	2,43	38	26	63,18	988,00
45x90 18"x36"	6	pallet 94x124	5	2,02	30,40	30	60,75	912,00
30x90 12"x36"	6	pallet 100x120	6	1,62	24,90	30	48,60	747,00
120x120 47"x47"	9	pallet con sponda 123x143	2	2,88	68	18	51,84	1.088,64
60x120x2 24"x47"x0,7"	20	-	1	0,72	-	36	25,92	1.188,00
60x60x2 24"x24"x0,7"	20	-	2	0,72	-	32	23,04	1.056,00
90x90 36"x36"	9	-	2	1,62	-	27	43,74	985,50
60x120 24"x47"	9	-	2	1,44	-	36	51,84	1.026,00
60x60 24"x24"	9	-	3	1,08	-	40	43,20	860,00
30x60 12"x24" rett.	9	-	7	1,26	-	40	50,40	960,00
30x60 12"x24" non rett.	9	-	7	1,26	-	40	50,40	980,00
30x30 12"x12" MOSAICO	9	-	11	1,00	-	30	30,00	570,00
7,5x60 3"x24" BATTISCOPIA	-	-	14	-	-	40	-	498,40
30x60 12"x24" STEP	-	-	7	-	-	36	-	1.008,00
33,3x120 13"x47"x1,57" GRADONE	-	-	2	-	-	20	-	328,00
33,3x120 13"x47"x1,57" ANGOLARE	-	-	2	-	-	20	-	328,00

KOMPAKT

Pag. 244







			M ² 		M ² 	Kg 
60x120 24"x47"	9	2	1,44	36	51,84	1.026,00
60x60 24"x24"	9	3	1,08	40	43,20	960,00
30x60 12"x24"	9	7	1,26	40	50,40	1.040,00
30x30 12"x12" MOSAICO	9	11	1,00	30	30,00	570,00
7,5x60 3"x24" BATTISCOPIA	-	14	-	40	-	498,40
30x60 12"x24" STEP	-	7	-	36	-	1.008,00

* Peso riferito a cassa completa. Per acquisti di lastre a cassa incompleta parziale sommare peso cassa/cavalletto [Ⓐ] e peso lastre [Ⓑ]
 Weight for complete crate. For order less than a full crate you need to add together the weight of the empty crate [Ⓐ] plus the weight of each slab [Ⓑ]
 Poids à la caisse complète. Pour les achats de dalles avec caisse incomplète ou partielle, sommer le poids de la caisse/chevalet [Ⓐ] et du poids de la dalle [Ⓑ]
 Gewicht einer vollen Kiste. Für Kommissionen bitte Kisten [Ⓐ] und Materialgewicht [Ⓑ] addieren.

I CEMENTI / Concrete effect / Cotto Imitation ciments / Beton-Optik







MATERIKA

Pag. 252

			M ² 		M ² 	Kg 
60x120 24"x47"	9	2	1,44	36	51,84	1.026,00
60x60 24"x24"	9	3	1,08	40	43,20	860,00
30x60 12"x24"	9	7	1,26	40	50,40	960,00
30x30 12"x12" MOSAICO	9	11	1,00	30	30,00	570,00
7,5x60 3"x24" BATTISCOPIA	-	14	-	40	-	498,40







STUCCHI

Pag. 260

			M ² 		M ² 	Kg 
90x90 36"x36"	9	2	1,62	27	43,74	985,50
60x120 24"x47"	9	2	1,44	36	51,84	1.026,00
60x60 24"x24"	9	3	1,08	40	43,20	860,00
30x60 12"x24"	9	7	1,26	40	50,40	960,00
30x30 12"x12" MOSAICO	9	11	1,00	30	30,00	603,00
7,5x60 3"x24" BATTISCOPIA	-	14	-	40	-	498,40

VENEXIA

Pag. 268







		tipologia imballo packaging		M ² 	Kg 		M ² 	Kg 
120x278 47"x109,45" (*)	6	cassa / crate 138x291x42 (vuoto/empty: 141 kg [Ⓐ])	1	3,34	Ⓑ 49,63	20	66,80	1.133,00*
90x90 36"x36"	6	pallet con sponda 94x124	3	2,43	38	26	63,18	988,00
45x90 18"x36"	6	pallet 94x124	5	2,025	30,40	30	60,75	912,00
30x90 12"x36"	6	pallet 100x120	6	1,62	24,90	30	48,60	747,00
60x60x2 24"x24"x0,7"	20	-	2	0,72	-	32	23,04	1.056,00
120x120 47"x47"	9	pallet con sponda 123x143	2	2,88	68	18	51,84	1.088,64
60x120 24"x47"	9	-	2	1,44	-	36	51,84	1.026,00
60x60 24"x24"	9	-	3	1,08	-	40	43,20	860,00
30x60 12"x24"	9	-	7	1,26	-	40	50,40	960,00
20x20 8"x8"	9	-	28	1,12	-	51	57,12	1.199,52
7,5x60 3"x24" BATTISCOPIA	-	-	14	-	-	40	-	498,40
33,3x120 13"x47"x1,57" GRADONE	-	-	2	-	-	20	-	328,00
33,3x120 13"x47"x1,57" ANGOLARE	-	-	2	-	-	20	-	328,00

Pesi e imballi / Weights and packaging / Poids et emballage / Gewichte und Verpackungen

I LEGNI / Wood effect / Imitation boi / Holz-Optik







ARBOR

Pag. 282

						
40x120x2 16"x47"x0,7"	20	2	0,96	32	30,72	1.376,00
20x120 8"x47"	9	6	1,44	45	64,80	1.282,50
6,5x120 2,56"x47" BATTISCOPIA	-	4	-	45	-	360,00







BADIA

Pag. 292

						
40x120x2 16"x47"x0,7"	20	2	0,96	32	30,72	1.376,00
30x120 12"x47"	9	3	1,08	45	48,60	990,00
20x120 8"x47"	9	6	1,44	45	64,80	1.282,50
7,5x120 3"x47" BATTISCOPIA	-	4	-	45	-	864,00

WOODER

Pag. 298

						
40x120x2 16"x47"x0,7"	20	2	0,96	32	30,72	1.376,00
20x120 8"x47"	9	6	1,44	45	64,80	1.282,50
49,6x9,6 19,53"x3,78" CHEVRON	9	16	0,766	50	38,32	672,00
6,5x120 2,56"x47" BATTISCOPIA	-	4	-	45	-	360,00

Movimentazione dei colli

Handling the packs / Manutention des charges / Handling der Ladungsträger

IT / Assicurarsi che il carrello elevatore sia dotato di forche di lunghezza sufficiente per movimentare le casse o i cavalletti forniti.

Le forche devono presentare la stessa lunghezza del lato del collo.

Una larghezza ottimale delle forche migliorerà la stabilità del carico. Assicurarsi che la capacità di carico del carrello elevatore sia adeguata alla movimentazione da eseguire.

Durante la movimentazione delle singole lastre utilizzare tutti i dispositivi di protezione individuale necessari.

EN / Make sure that the forklift is equipped with forks of a suitable length for handling the delivered crates or A-frames. The forks should be of the same length as the side of the package.

Optimal fork width will improve the load's stability. Ensure that the forklift's load capacity is suitable for handling. Use all necessary personal protective equipment when moving the individual slabs.

FR / S'assurer que le chariot élévateur est équipé de fourches de longueur appropriée pour la manutention des caisses ou des palettes chevalets.

Les fourches doivent être de la même longueur que le côté de la charge à lever.

Une largeur de fourche adéquate favorise la stabilité de la charge. S'assurer que la capacité de charge du chariot élévateur est adaptée à la charge à lever. Utiliser tous les EPI nécessaires pendant la manutention des dalles.

DE / Vergewissern Sie sich, dass der Gabelstapler über ausreichend lange Hubgabeln für das Handling der gelieferten Transportkisten oder A-Bockpaletten verfügt. Die Hubgabeln müssen dieselbe Länge aufweisen wie die Seiten des Ladeguts.

Eine optimale Gabelbreite verbessert die Stabilität der Ladung. Vergewissern Sie sich, dass die Tragfähigkeit des Gabelstaplers auf die jeweilige Transportaufgabe abgestimmt ist. Schützen Sie sich beim Bewegen der einzelnen Platten mit der notwendigen persönlichen Sicherheitsausrüstung.

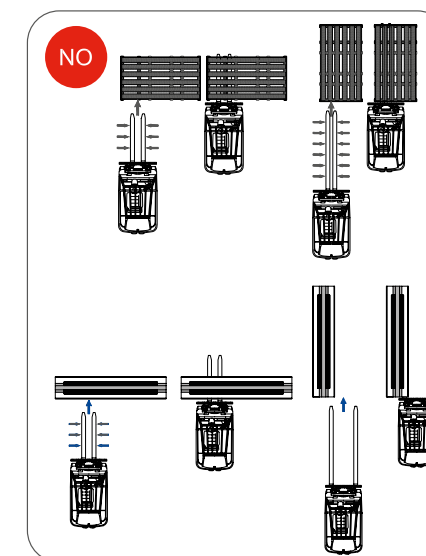
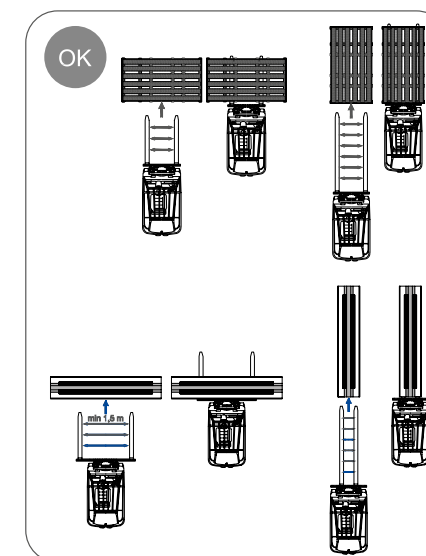

Aprire le forche fino all'estensione massima, quindi inforcare i colli (ad es. casse, pallet) esattamente al centro.

Open the forks to their maximum extension and pick up the packs (e.g. crates, pallets) in the very centre.

Ouvrir les fourches au maximum et les glisser sous la charge (caisse, palette, etc.) bien au centre de celle-ci.

Fahren Sie die Hubgabeln bis zu ihrer vollen Breite aus und nehmen Sie das Ladegut (z.B. Kisten oder Paletten) mittig auf.

Movimentazione dei colli Handling the packs / Manutention des charges / Handling der Ladungsträger

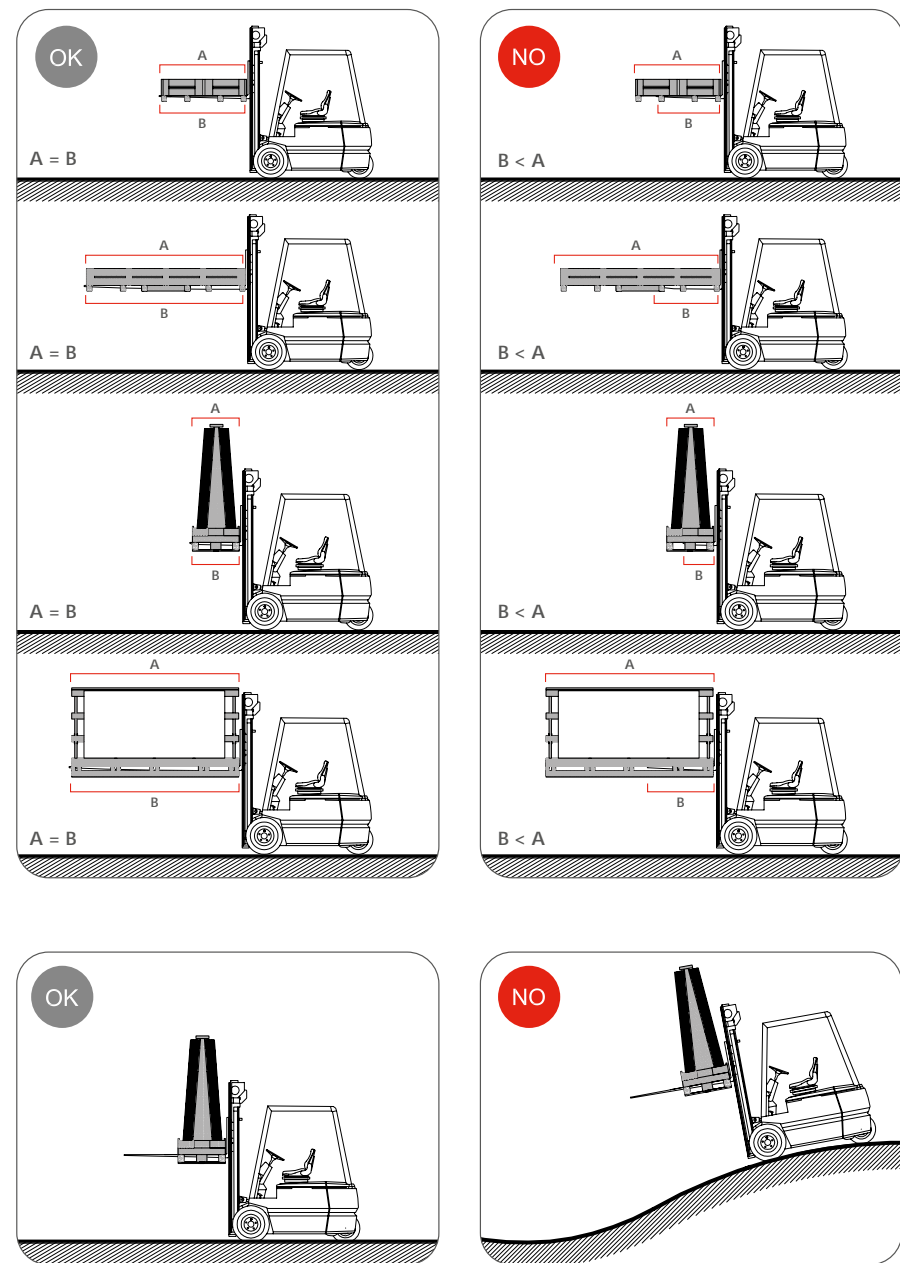

Utilizzare carrelli elevatori con la giusta capacità di carico e con forche di lunghezza adeguata alle dimensioni dei colli.

Use lift trucks with the correct capacity and a fork length that matches the dimensions of the packs.

Utiliser des chariots élévateurs de capacité adaptée et équipés de fourches dont la longueur correspond aux dimensions des charges à lever.

Verwenden Sie Flurförderzeuge mit einer geeigneten Tragfähigkeit und einer auf die Maße des Ladeguts abgestimmten Hubgabellänge.

Spostarsi solo lungo percorsi in piano..

Move only along level pathways.

Ne déplacer la charge que sur terrain plat.

Bewegen Sie sich ausschließlich auf ebenen Verkehrsflächen.

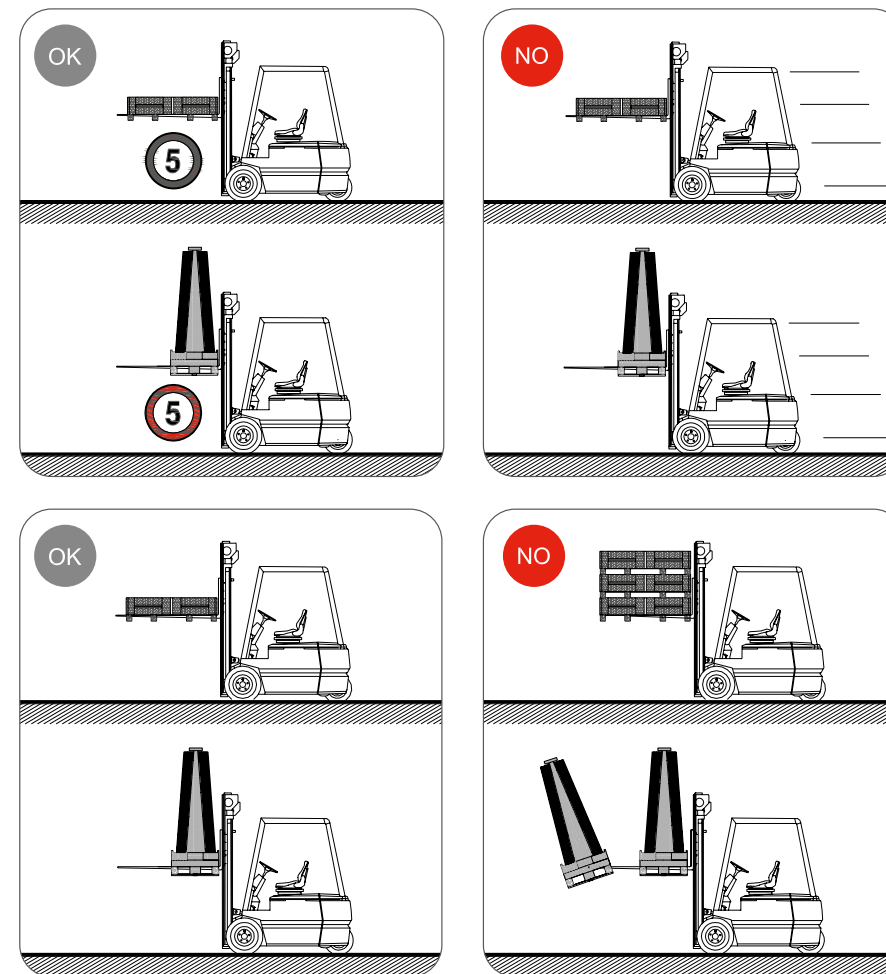

Spostare i colli con attenzione, mantenendo una velocità bassa per l'intero tragitto.

Move the packs with care, maintaining a slow speed for the entire journey.

Manipuler les charges avec précaution en procédant à vitesse réduite sur tout le parcours.

Bewegen Sie das Ladegut mit Sorgfalt und behalten Sie während des gesamten Transports eine niedrige Geschwindigkeit bei.

Non spostare mai più di un collo per volta.

Never move more than one pack at a time.

Ne jamais manipuler plus d'une charge à la fois.

Nehmen Sie niemals mehr als einen Ladungsträger auf.

Movimentazione dei colli Handling the packs / Manutention des charges / Handling der Ladungsträger

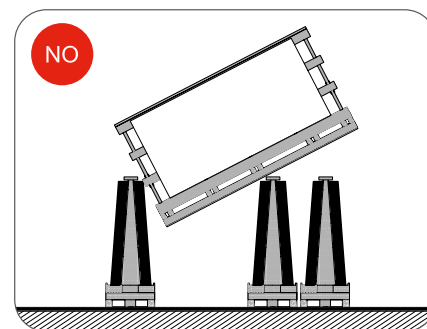
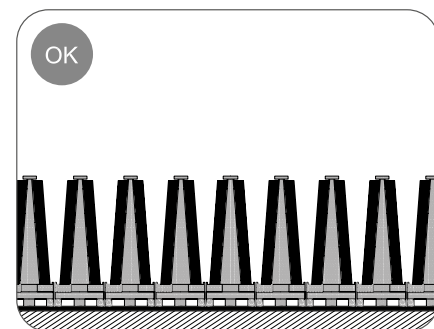
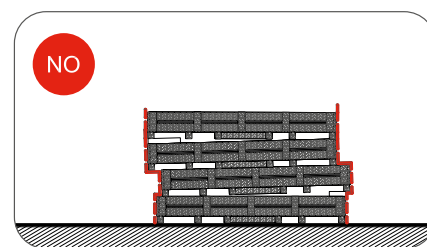
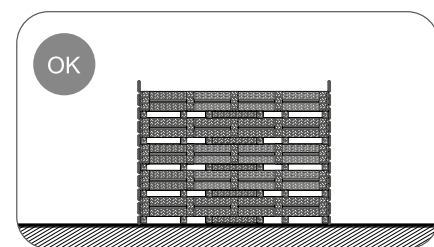
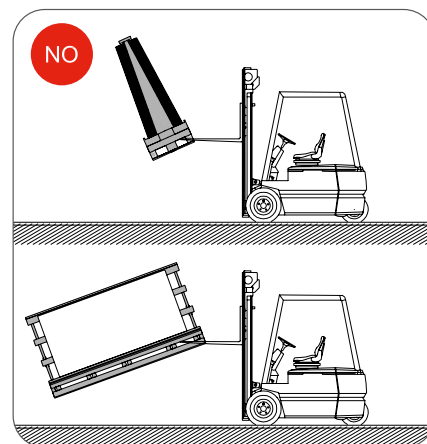
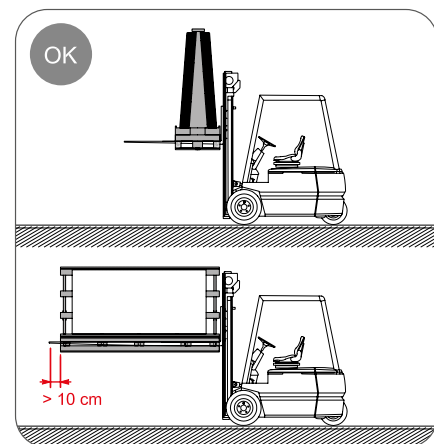

Assicurarsi che le casse siano perfettamente allineate quando vengono impilate, in caso contrario potrebbero non essere stabili.

Ensure the crates are perfectly aligned when stacking, otherwise they could be unstable.

S'assurer que les caisses sont parfaitement alignées au moment de les empiler. Dans le cas contraire, la pile risque d'être instable.

Vergewissern Sie sich, dass die Kisten beim Stapeln perfekt zueinander ausgerichtet und im Gleichgewicht sind, da sie ansonsten instabil werden.

Non impilare mai pallet con cavalletti.

Never stack A-frame pallets.

Ne jamais empiler les palettes chevalets.

Stapeln Sie niemals A-Bockpaletten.

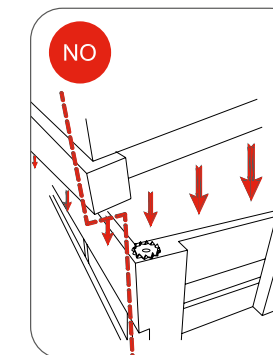
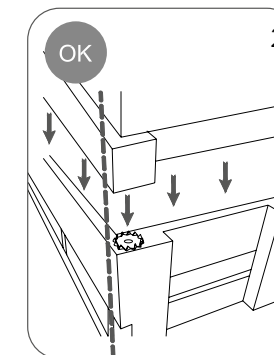
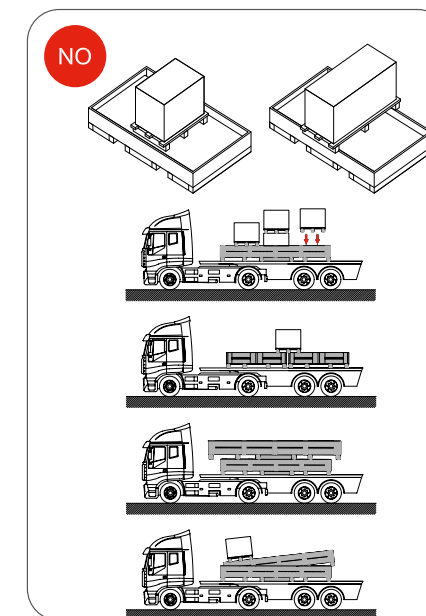
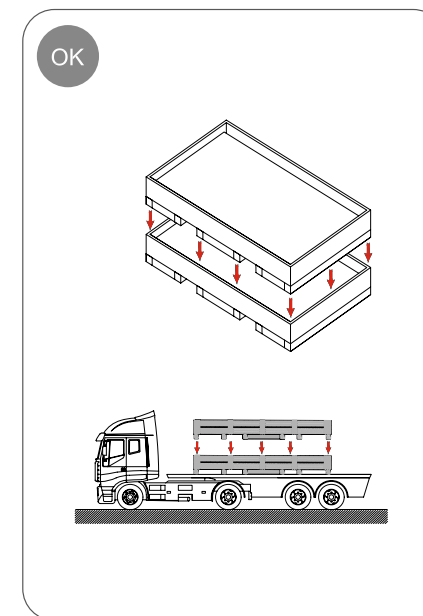

Impilare solo casse aventi la stessa forma. Non collocare nulla, neppure oggetti con la stessa forma, sulla superficie superiore della cassa.

Only stack crates of the same shape. Do not place anything, not even items of the same shape, on the crate's top surface.

N'empiler que les caisses de même format. Ne placez rien, pas même des objets de même forme, sur le dessus de la caisse.

Stapeln Sie ausschließlich gleichförmige Kisten. Stellen oder legen Sie keine Lasten auf die Kistenoberseite. Auch keine gleichförmigen Objekte.

¹ Le rondelle metalliche utilizzate per impilare le casse sono taglienti e possono causare lesioni in caso di urto. Non toccarle.

² Quando si impilano le casse, assicurarsi che le rondelle sulla cassa sottostante siano perfettamente centrali.

¹ The metal washers used for stacking crates are sharp and can cause injury on impact! Do not touch them.

² When stacking crates, ensure the washers on the crate below are completely central.

¹ Les rondelles métalliques utilisées pour empiler les caisses sont tranchantes et peuvent provoquer des blessures en cas d'impact ! Ne pas les toucher.

² Lors de l'empilage des caisses, s'assurer que les rondelles de la caisse du dessous sont correctement centrées.

¹ Die zum Stapeln der Kisten verwendeten Metallscheiben sind scharf und können bei einer Kollision zu Verletzungen führen! Vermeiden Sie die Berührung.

² Vergewissern Sie sich beim Stapeln von Kisten, dass die unteren Scheiben an der Kiste genau zentriert sind.

Movimentazione dei colli Handling the packs / Manutention des charges / Handling der Ladungsträger

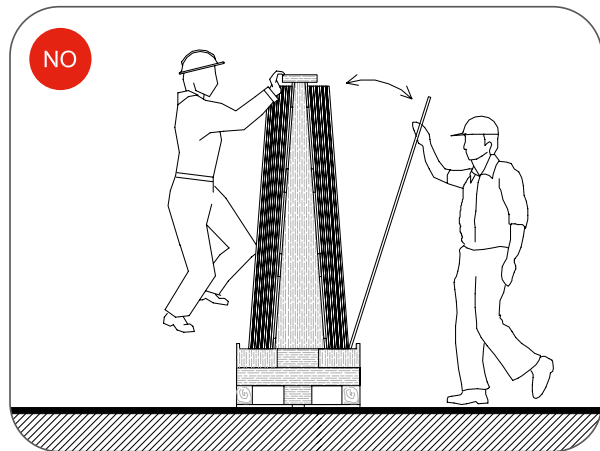

Movimentare le lastre posizionate sul cavalletto con estrema cautela e solo dopo aver escluso ogni pericolo per l'operatore (cinghie allentate, instabilità delle lastre ecc.). Utilizzare i DPI adeguati durante tutte le operazioni di movimentazione, che devono essere eseguite da operatori dedicati e appositamente formati.

Move the slabs placed on the trestle with extreme caution, and only after checking there are no dangers to the operator (slack straps, unstable slabs, etc.). During all handling operations, which must be carried out only by dedicated operators trained for the purpose, use appropriate PPE.

Déplacer les dalles placées sur le chevalet avec une extrême prudence, et uniquement après avoir vérifié que cette manœuvre est sans danger pour l'opérateur (sangles détendues, dalles instables, etc.). Utiliser des EPI appropriés pendant toutes les opérations de manutention, qui ne doivent être effectuées que par des opérateurs spécialisés et formés à cet effet.

Bewegen Sie auf A-Bockpaletten befestigte Platten nur mit extremer Vorsicht und erst, nachdem Sie überprüft haben, dass dies für den Bediener gefahrlos möglich ist (keine losen Riemen, instabilen Platten usw.). Verwenden Sie während des gesamten Handlings, das ausschließlich von geschultem Fachpersonal durchgeführt werden darf, eine angemessene Sicherheitsausrüstung.

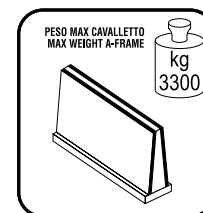
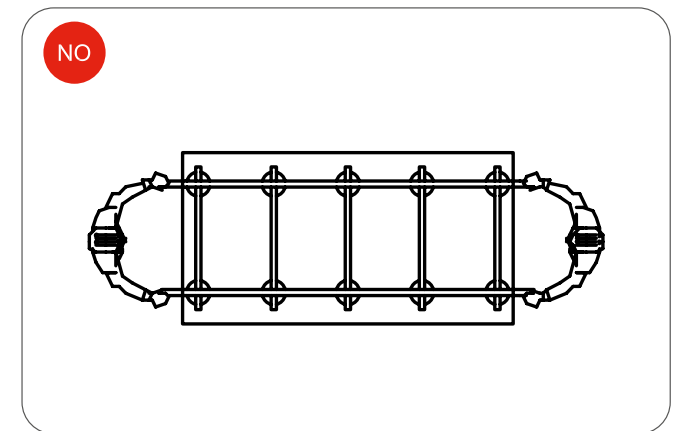
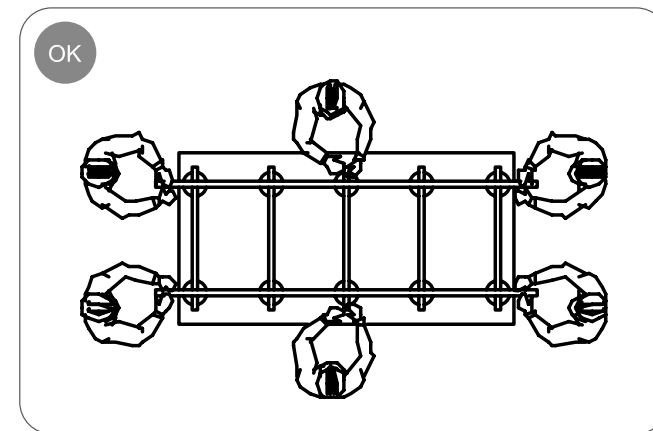
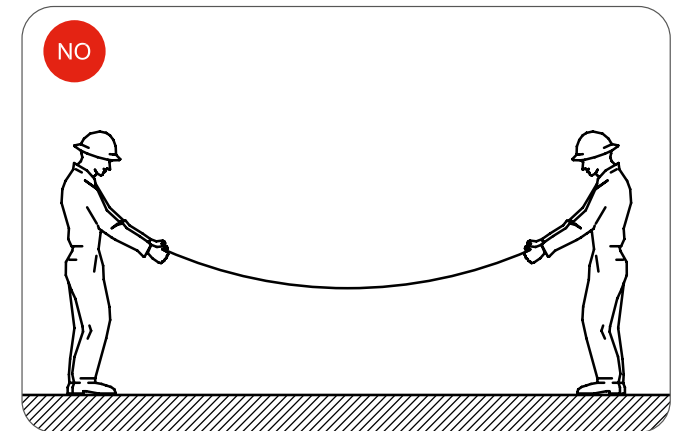
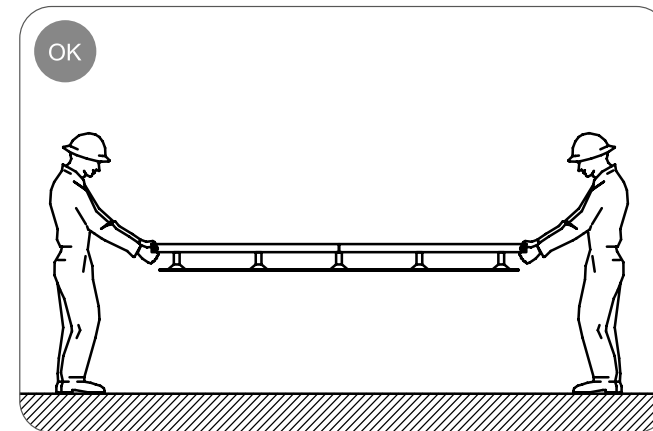
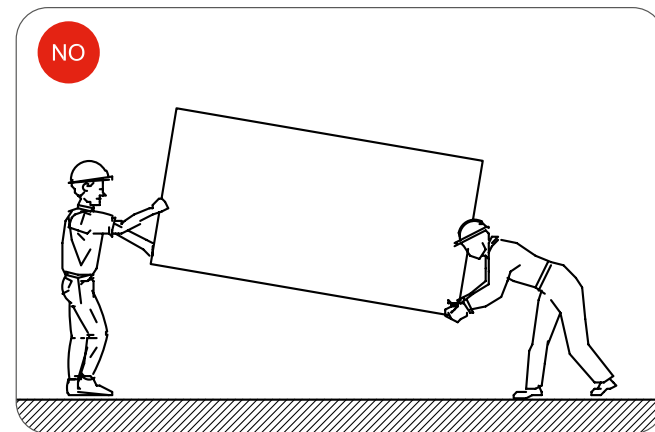
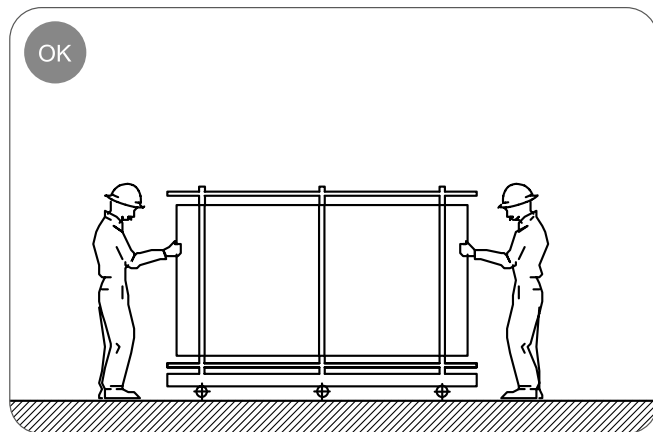

Immagazzinare al coperto ed al riparo da umidità e luce solare.
Store indoors and away from humidity and sunlight.
Conserver à l'intérieur et à l'abri de l'humidité et du soleil.
Im Innenbereich vor Feuchtigkeit und Sonnenlicht schützen.

Gres porcellanato colorato in massa



Porcelained stoneware with mass colouring / Grès cérame avec pate colorée / Durchgefärbtes Feinsteinzeug

Caratteristiche Tecniche / Technical Features / Caracteristiques Techniques / Technische Eigenschaften
Bla GL Gruppo di Appartenenza secondo ISO 13006 / Class / Groupe d'appartenance / Zugehörigkeitsgruppe

SIMBOLOGIA Symbolics Symboles Symbole	CARATTERISTICA Features Caracteristiques Eigenschaften	UNITÀ DI MISURA Unit of measurement Unité de mesure Masseinheit	VALORE MEDIO ALFALUX Alfalux mean value Valeur moyenne Alfalux Durchschnitts-Werf-Alfalux	VALORE PRESCRITTO Fixed value Valeur prescrite Vorgeschriebener Wert	METODO DI PROVA Test method Méthode d'essai Prüfmethode
	RETTILINEITÀ DEI LATI Side straightness Rectitude des arêtes Geractlinigkeit der Kanten	%	+/- 0,4	+/- 0,5 max	UNI EN ISO 10545-2
	ORTOGONALITÀ DEGLI SPIGOLI Corner squariness Angularité Rechtwinkligkeit der Kanten	%	+/- 0,4	+/- 0,6 max	UNI EN ISO 10545-2
	PLANARITÀ Flatness Planéité Ebenflächigkeit	%	+/- 0,4	+/- 0,5 max	UNI EN ISO 10545-2
	SPESSORE Thickness Epaisseur Dicke	%	+/- 5,0	+/- 5,0	UNI EN ISO 10545-2
	ASSORBIMENTO D'ACQUA Water absorption Absorption d'eau Wasseraufnahme	%	< 0,2	< = 0,5	UNI EN ISO 10545-3
	SFORZO DI ROTTURA Breaking strenght Contrainte de rupture Bruchkraft	N	≥ 1600 se sp ≥ 7,5 mm ≥ 700 se sp ≤ 7,5 mm	≥ 1300 se sp ≥ 7,5 mm ≥ 700 se sp < 7,5 mm	UNI EN ISO 10545-4
	MODULO DI ROTTURA Modulus of rupture Coefficient de rupture Bruchmodul	N/mm ²	> 40	≥ 35	UNI EN ISO 10545-4
	DILATAZIONE TERMICA LINEARE Coeff. of linear thermal expansion Coeff. d'extension thermique linéaire Linearer Wärmeausdehnungs-Koeffizient	°MK(-1)	7,0	METODO DISPONIBILE available method methode disponible verfügbare methode	UNI EN ISO 10545-8
	RESISTENZA AGLI SBALZI TERMICI Thermal shock resistyance Résistance aux chocs termiques Temperaturwechsel beständig keit	-	RESISTE résiste widerstandsfähig	METODO DISPONIBILE available method methode disponible verfügbare methode	UNI EN ISO 10545-9
	RESISTENZA AI PRODOTTI CHIMICI DI USO DOMESTICO Resistance to chemical products Résistance aux produits chimiques Beständigkeit gegen Chemikalien	-	CONFORME conform conforme gleichmässig	MINGB	UNI EN ISO 10545-13
	RESISTENZA AGLI ACIDI E ALLE BASI A BASSA CONCENTRAZIONE Resistant to acids and low concentration bases Résistance aux acides et aux bases à faible concentration Widerstandsfähig gegenüber niedrig konzentrierten Säuren und Laugen	-	≤ GLB	SECONDO CLASSIFICAZIONE FABBRICANTE upon producer rating selon la classification du fabricant laut fabrikant klassifikation	UNI EN ISO 10545-13
	RESISTENZA AL GELO Frost resistance Résistance au gel Frostbeständigkeit	-	RESISTE résiste widerstandsfähig	RICHIESTA request demande anfrage	UNI EN ISO 10545-12
	STABILITÀ DEI COLORI Colour stability Stabilité des coloris Lichtechtheit der Färbung	-	STABILE stable stable stabil	METODO DISPONIBILE available method methode disponible verfügbare methode	DIN 51094
	RESISTENZA ALLE MACCHIE Breaking strenght Résistance au tâches Flecken beständigkeit	-	≥ 3	3 MIN	UNI EN ISO 10545-14
	RESISTENZA ALL'ABRASIONE Resistance to abrasion Résistance à l'abrasion Beständigkeit gegen Oberflächenverschiss	-	SECONDO LA SERIE	CLASSE 1-5	UNI EN ISO 10545-7

Per verificare le serie certificate QB UPEC si consiglia di consultare il sito ufficiale CSTB
To check the QB UPEC certified series we recommend consulting the official CSTB website
Pour vérifier les séries certifiées QB UPEC nous vous recommandons de consulter le site officiel du CSTB
Um welche Serie zertifiziert UPEC feststellen , bitte die offizielle Website CSTB abpruefen

Gres porcellanato smaltato



Glazed gres porcelain / Grès cérame émaillé / Glasierte feinsteinzeug

Caratteristiche Tecniche / Technical Features / Caracteristiques Techniques / Technische Eigenschaften
Bla GL Gruppo di Appartenenza secondo ISO 13006 / Class / Groupe d'appartenance / Zugehörigkeitsgruppe

SIMBOLOGIA Symbolics Symboles Symbole	CARATTERISTICA Features Caracteristiques Eigenschaften	UNITÀ DI MISURA Unit of measurement Unité de mesure Masseinheit	VALORE MEDIO ALFALUX Alfalux mean value Valeur moyenne Alfalux Durchschnitts-Werf-Alfalux	VALORE PRESCRITTO Fixed value Valeur prescrite Vorgeschriebener Wert	METODO DI PROVA Test method Méthode d'essai Prüfmethode
	RETTILINEITÀ DEI LATI Side straightness Rectitude des arêtes Geractlinigkeit der Kanten	%	+/- 0,4	+/- 0,5 max	UNI EN ISO 10545-2
	ORTOGONALITÀ DEGLI SPIGOLI Corner squariness Angularité Rechtwinkligkeit der Kanten	%	+/- 0,4	+/- 0,6 max	UNI EN ISO 10545-2
	PLANARITÀ Flatness Planéité Ebenflächigkeit	%	+/- 0,4	+/- 0,5 max	UNI EN ISO 10545-2
	SPESSORE Thickness Epaisseur Dicke	%	+/- 5,0	+/- 5,0	UNI EN ISO 10545-2
	ASSORBIMENTO D'ACQUA Water absorption Absorption d'eau Wasseraufnahme	%	< 0,4	< = 0,5	UNI EN ISO 10545-3
	SFORZO DI ROTTURA Breaking strenght Contrainte de rupture Bruchkraft	N	≥ 1600 se sp ≥ 7,5 mm ≥ 700 se sp ≤ 7,5 mm	≥ 1300 se sp ≥ 7,5 mm ≥ 700 se sp < 7,5 mm	UNI EN ISO 10545-4
	MODULO DI ROTTURA Modulus of rupture Coefficient de rupture Bruchmodul	N/mm ²	> 38	≥ 35	UNI EN ISO 10545-4
	DILATAZIONE TERMICA LINEARE Coeff. of linear thermal expansion Coeff. d'extension thermique linéaire Linearer Wärmeausdehnungs-Koeffizient	°MK(-1)	7,0	METODO DISPONIBILE available method methode disponible verfügbare methode	UNI EN ISO 10545-8
	RESISTENZA AGLI SBALZI TERMICI Thermal shock resistyance Résistance aux chocs termiques Temperaturwechsel beständig keit	-	RESISTE résiste widerstandsfähig	METODO DISPONIBILE available method methode disponible verfügbare methode	UNI EN ISO 10545-9
	RESISTENZA AI PRODOTTI CHIMICI DI USO DOMESTICO Resistance to chemical products Résistance aux produits chimiques Beständigkeit gegen Chemikalien	-	CONFORME conform conforme gleichmässig	MINGB	UNI EN ISO 10545-13
	RESISTENZA AGLI ACIDI E ALLE BASI A BASSA CONCENTRAZIONE Resistant to acids and low concentration bases Résistance aux acides et aux bases à faible concentration Widerstandsfähig gegenüber niedrig konzentrierten Säuren und Laugen	-	≤ GLB	SECONDO CLASSIFICAZIONE FABBRICANTE upon producer rating selon la classification du fabricant laut fabrikant klassifikation	UNI EN ISO 10545-13
	RESISTENZA AL GELO Frost resistance Résistance au gel Frostbeständigkeit	-	RESISTE résiste widerstandsfähig	RICHIESTA request demande anfrage	UNI EN ISO 10545-12
	STABILITÀ DEI COLORI Colour stability Stabilité des coloris Lichtechtheit der Färbung	-	STABILE stable stable stabil	METODO DISPONIBILE available method methode disponible verfügbare methode	DIN 51094
	RESISTENZA ALLE MACCHIE Breaking strenght Résistance au tâches Flecken beständigkeit	-	≥ 3	3 MIN	UNI EN ISO 10545-14
	RESISTENZA ALL'ABRASIONE Resistance to abrasion Résistance à l'abrasion Beständigkeit gegen Oberflächenverschiss	-	SECONDO LA SERIE	CLASSE 1-5	UNI EN ISO 10545-7





Per verificare le serie certificate QB UPEC si consiglia di consultare il sito ufficiale CSTB
To check the QB UPEC certified series we recommend consulting the official CSTB website
Pour vérifier les séries certifiées QB UPEC nous vous recommandons de consulter le site officiel du CSTB
Um welche Serie zertifiziert UPEC feststellen , bitte die offizielle Website CSTB abpruefen

Categorie di resistenza allo scivolamento

Slip resistance categories / Catégories de résistance à la glissance / Rutschfestigkeitskategorien

EN 16165:2012 ANNEX A

Classificazione rischio con piedi calzati / Risk classification with footwear
Classement risque marche pieds chaussés / Risikoklassifizierung für begehung mit schuhwerken

Coefficiente di attrito Coefficient of friction Coefficient de friction Reibungskoeffizient	Angoli di inclinazione Angle Angle d'inclination Neigungswinkel	Campi di applicazione Field of application Domaines d'utilisation Anwendungsbereich
R9	 6°:10°	Parti comuni condominiali Common property parts Parties communes en copropriété Gemeinschaftsbereiche von mehrfamilienhäusern
R10	 10°:19°	Toilettes, magazzini, garages cucine di locali pubblici, ecc. Bathrooms, warehouses, garages, kitchens of restaurants, etc. Toilettes magasins, gara-es cuisines d'établissements publics, etc. Toiletten, Lagerhallen, Garagen, Großküchen usw.
R11	 20°:27°	Lavorazione formaggi, celle frigorifere, lavanderie, ecc. Dairies, cold rooms, laundries, etc. Travail du fromage, chambres frigorifiques, blanchisseries, etc Kaserei Wäscherei, Küdhiraume usw.
R12	 28°:35°	Lavorazione carni, cucine industriali, zuccherifici, ecc. Meat processing industrial kitchens, sugar production, etc Travail de la viande, cuisines industrielles sucreries, etc. Fleischverarbeitungstatten Industrieküchen Zuckerfabriken usw.



EN 16165:2012 ANNEX B

Classificazione rischio a piedi nudi / Risk classification barefoot
Classement risque marche pieds nus / Risikoklassifizierung für barfussbegehung

Gruppi di valutazione Evaluation groups Groupes d'estimation Bewertungsgruppen	Angoli di inclinazione Angle Angle d'inclination Neigungswinkel	Campi di applicazione Field of application Domaines d'utilisation Anwendungsbereich
A	≥ 12°	Spogliatoi, zone di passaggio a piedi nudi, ecc. Dressing rooms areas likely to be walked on barefoot, etc. Vestiaires, zone de passage les pieds nus, etc. Umklederäume, Barfuß-Durchgangsbereiche usw.
B	≥ 18°	Docce, bordi piscine, ecc.. Shower enclosures, swimming pool decks, etc. Douches, bords des piscines, etc. Duschen Schwimmbadrande usw.
C	≥ 24°	Bordi di piscine in pendenza, scale immerse ecc. Sloping swimming pool decks, submerged stairs, etc. Bords des piscines en pente, escaliers plongés, etc. Schwimmbadrande mit Gefälle sich im Wasser befindliche Treppen usw.

V

Volume minimo di deflusso dell'acqua (drenaggio)
Minimum water drainage level / Volume de reflux de l'eau (drainage) minimum / Mindest-entwässerungsraum (drainage)

V4

4 cm³ / dm²: indicato per autolavaggi, produzione mangimi, cucine ospedali, ecc.
4 cm³ / dm³. suitable for car washes, fodder production plant hospital kitchen, etc / 4 cm³ / dm³ indiqué pour les postes de lavage voitures, la production des provendes les cuisines des hopitaux / 4 cm³ / dm³: geeignet für Autowaschanlagen, Futterherstellung, Krankenhausküchen usw.

Total Outdoor

IT / LA NATURA DIVENTA VERSATILE

La tecnologia permette di dare un volto poliedrico alla natura valorizzandone le caratteristiche. **Total Outdoor** si declina in diversi colori, finiture per completare al meglio le aree esterne di ambienti privati e commerciali. I diversi spessori permettono di giocare con le soluzioni di posa per dare continuità tra gli ambienti.

EN / NATURE BECOMES VERSATILE

Technology gives nature a multi-faceted appearance and enhances its features. **Total Outdoor** has a range of colours and finishes to perfectly complement outdoor areas in private and commercial spaces. The various thicknesses allow you to explore laying solutions and bring continuity to spaces.

FR / LA NATURE DEVIENT POLYVALENTE

La technologie permet de donner un visage polyédrique à la nature en valorisant ses caractéristiques. **Total Outdoor** se décline en différentes couleurs et finitions afin de compléter au mieux les zones extérieures d'espaces privés et commerciaux. Les différentes épaisseurs permettent de jouer avec les solutions de pose pour assurer la continuité entre les espaces.

DE / DIE NATUR WIRD VIELSEITIG

Mit der Technologie lässt sich der Natur ein abwechslungsreiches Aussehen verleihen und dabei ihre Merkmale betonen. **Total Outdoor** dekliniert sich in verschiedene Farben, Oberflächengestaltungen und ermöglicht die Ergänzung von Außenanlagen im privaten wie im gewerblichen Bereich. Die unterschiedlichen Dicken gestatten das Spiel mit den Verlegelösungen, um die Kontinuität zwischen den Räumlichkeiten zu garantieren.



ESEMPIO DI APPLICAZIONE STRUTTURE DI SUPPORTO

APPLICATION EXAMPLE SUPPORT STRUCTURES / EXEMPLE D'APPLICATION STRUCTURES DE SUPPORT / ANWENDUNGSBEISPIEL STÜTZSTRUKTUR

OUTDOOR 2CM
60x60
24"x24"

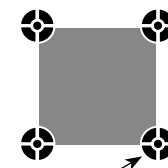

Piedino in polipropilene
Feet in polypropylene
Pied en polypropylène
Fuß aus Polypropylen

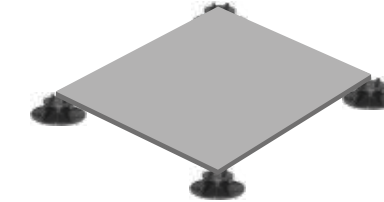
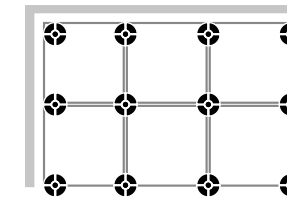

OUTDOOR 2CM
40x120
16"x47"

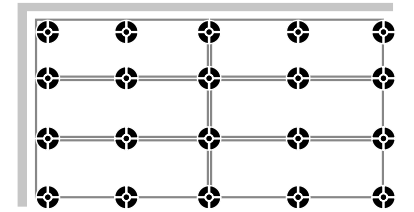

Nel caso di pavimentazioni ad uso pubblico o in presenza di carichi elevati Alfalux prescrive l'adozione di supporti aggiuntivi sotto la lastra come da schema sotto

In the case of flooring for public use or where there are high loads, Alfalux recommends the adoption of additional supports under the slab, as in the diagram below

En cas de sol à usage public ou en présence de charge élevées, Alfalux préconise d'utiliser des plots supplémentaires à placer sous la dalle comme indiqué sur les images ci-dessous

Im Falle von Bodenbelägen im öffentlichen Bereich oder bei Vorkommen von hohen Belastungen schreibt Alfalux die Verwendung von zusätzlichen Halterungen vor, die gemäß nachfolgender Zeichnung unter der Platte angebracht werden

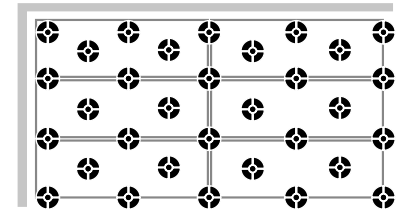
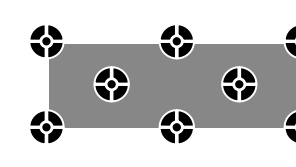
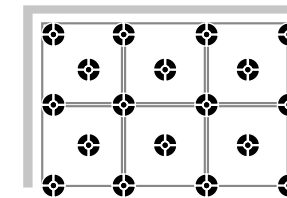
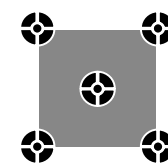

Nel caso sia richiesta un'altezza di sopraelevazione superiore ai 10 cm, Alfalux prescrive l'incollaggio di lamina o rete di sicurezza sul retro e supporti aggiuntivi sotto la lastra come da schema sotto:

If a raised height of over 10 cm is required, Alfalux recommends glueing foil or mesh to the back for safety and adding supports under the slab, as in the diagram below:

Si une surélévation supérieure à 10 cm est nécessaire, Alfalux préconise de coller une tôle ou un grillage de sécurité au dos de la dalle et des plots supplémentaires sous la dalle, comme indiqué sur les images ci-dessous:

Falls eine Erhöhung von mehr als 10 cm benötigt wird, schreibt Alfalux die Verklebung eines Blechs oder eines Sicherheitsnetzes auf der Rückseite, sowie zusätzliche Halterungen unter der Platte vor, wie auf der Zeichnung unten gezeigt:

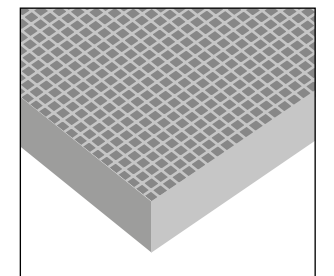



Total Outdoor 20MM collections

ATLANTIS
20MM



SABBIA PERLA FUMO LAVA

60x60 24"x24" GRIP RETT. 60x120 24"x47" GRIP RETT.

ARBOR
20MM



CIPRESSO GELSO ROVERE



40x120 16"x47" GRIP RETT.

BADIA
20MM



ACACIA FRASSINO TUIA



40x120 16"x47" ROC RETT.

BLENDSTONE
20MM



BIANCO BEIGE GRIGIO





60x60 24"x24" GRIP RETT. 60x120 24"x47" GRIP RETT.

CEMENTART
20MM



BIANCO FUMO SABBIA PERLA





60x60 24"x24" GRIP RETT. 60x120 24"x47" GRIP RETT.

COTTAGE
20MM



MILK HONEY TAUPE MUD

60x60 24"x24" GRIP RETT. 60x120 24"x47" GRIP RETT.

GARDA
20MM



RIVA LUGANA SIRMIONE





60x60 24"x24" GRIP RETT. 60x120 24"x47" GRIP RETT.

NEUTRA ROC
20MM



AVORIO BEIGE PIOMBO NERO

60x60 24"x24" ROC RETT.

PANGEA
20MM



BEIGE CENERE GRIGIO





60x60 24"x24" GRIP RETT. 60x120 24"x47" GRIP RETT.

PIETRE PURE
20MM



OSTUNI BORGOGNA PIASENTINA BAGNOLO VICENZA





60x60 24"x24" ROC RETT.

STONEQUARTZ
20MM



BIANCO PERLA GRIGIO BEIGE NERO



60x60 24"x24" GRIP RETT. 60x120 24"x47" GRIP RETT.

VENEXIA
20MM



GIUDECCA MURANO



60x60 24"x24" GRIP RETT.

WOODER
20MM



CLOVE LIME MAPLE



40x120 16"x47" GRIP RETT.

Posa in outdoor

Outdoor laying / Pose en extérieur / Verlegung im Freien



20 MM



20 MM



20 MM



20 MM



20 MM 9 MM
10 MM 8 MM

Posa su ghiaia

Valorizza gli spazi esterni con una posa facile e veloce. Permette il drenaggio dell'acqua piovana nel terreno.

Laying on gravel

Easy, fast installation to enhance outdoor spaces. Allows rainwater to drain into the ground.

Pose sur gravier

Elle met en valeur les espaces extérieurs grâce à une pose facile et rapide. Elle permet le drainage de l'eau de pluie dans le terrain.

Verlegung auf kies

Verschönert außenbereiche mit einer einfachen und schnellen verlegung. Gestattet das ableiten von regenwasser in das erdreich.

Posa su erba

Una soluzione veloce che arricchisce e completa gli spazi verdi creando vialetti e camminamenti anche in aree pubbliche.

Laying on grass

A rapid solution that enhances and completes green spaces, creating paths and walkways, including in public areas.

Pose sur herbe

Une solution rapide qui enrichit et complète les espaces verts en créant des allées et des cheminements dans des zones publiques également.

Verlegung auf gras

Eine schnelle lösung, die grünflächen bereichert und ergänzt und dabei wege und gassen auch in öffentlichen bereichen schafft.

Posa su sabbia

Un materiale resistente al sole e alla salsedine, perfetto per le aree marittime e facilmente riposizionabile ogni anno.

Laying on sand

A material that resists sun and salt, perfect for areas by the sea and easy to reposition each year.

Pose sur sable

Un matériau résistant au soleil et aux embruns, parfait pour les zones maritimes et facile à remettre en place tous les ans.

Verlegung auf sand

Einen sonnen- und salzresistentes material, das sich perfekt für das meer eignet und jedes jahr bequem neu verlegt werden kann.

Posa sopraelevata

I supporti permettono di rendere regolari tutte le superfici e permette di nascondere cavi e tubature.

Raised laying

Supports allow you to make all surfaces regular and conceal cables and tubes.

Pose surelevee

Les supports permettent de rendre régulières toutes les surfaces et de dissimuler câbles et tuyauteries.

Erhöhte verlegung

Durch die unterlagen können ngleichmäßige böden nivelliert werden und kabel und leitungen lassen sich bequem verstecken.

Posa su massetto

La posa a colla rende la superficie perfetta anche per le zone carrabili. Questa posa tradizionale è adatta anche agli spazi industriali.

Laying on screed

Adhesive laying makes the surface perfect for driveways. This traditional laying system is also suitable for industrial spaces.

Pose sur chape

Les supports permettent de rendre régulières toutes les surfaces et de dissimuler câbles et tuyauteries.

Verlegung auf estrich

Die verlegung mit klebstoff schafft perfekte oberflächen auch in befahrbaren bereichen. Diese traditionelle verlegung eignet sich auch für industrieräume.

Posa sopraelevata

Raised laying / Pose surelevee / Erhöhte verlegung



20 MM

I supporti permettono di rendere regolari tutte le superfici e permette di nascondere cavi e tubature

SUPPORTI DI SOSTEGNO

Supports

Plots

Stelzlager

FORMATO PIASTRA Tile format Format dalle Formater	N° SUPPORTI/m ² N° supports/m ² N° plots/m ² Stelzlagerstücke/m ²
60x120	5,6 pz
40x120	6,25 pz
60x60	2,8 pz

SUPPORTI FISSI / Fixed supports / Plots fixes / Fixe Stelzlager



H(mm) 25
7327019



H(mm) 35

SUPPORTI REGOLABILI IN ALTEZZA / Support with adjustable height Plots réglables en hauteur / Stelzlager mit einstellbarer Höhe



H(mm) 35-50
7326979



H(mm) 50-70
7326989



H(mm) 65-100
7326999

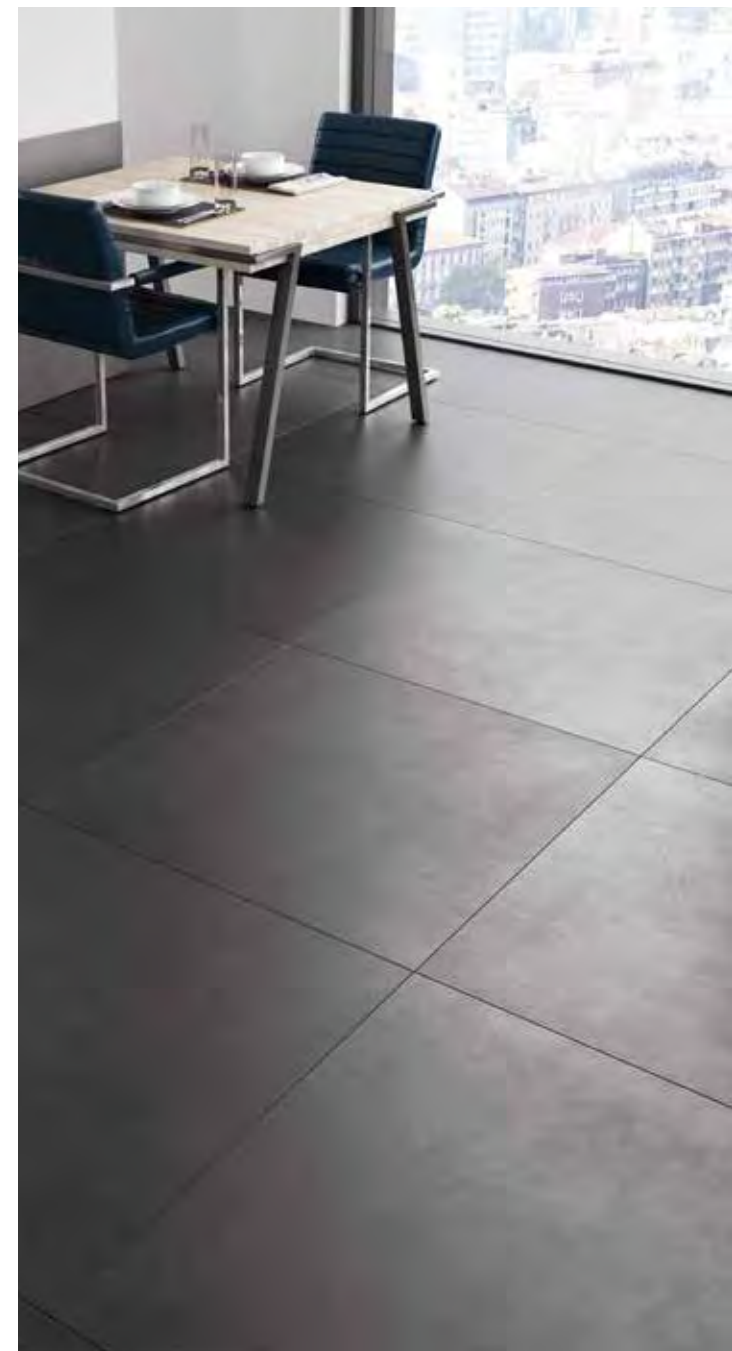

Pezzi speciali 20MM su richiesta

Trims 20 MM on demand / Accessoires 20 MM sur demande / Formstücke 20 MM auf anfrage



20 MM

ELEMENTO AD ELLE 20MM ROC RETTIFICATO GRIP RETTIFICATO

30x60x6,5 12"x24"x2,36"
40x120x6,5 16"x47"x2,36"

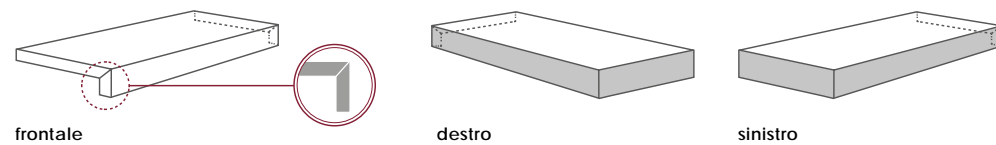

GRADONE TORO 20MM* RETTIFICATO (SMALTATO) RETTIFICATO (NON SMALTATO)

30x60x2 12"x24"x0,7"
40x120x2 16"x47"x0,7"

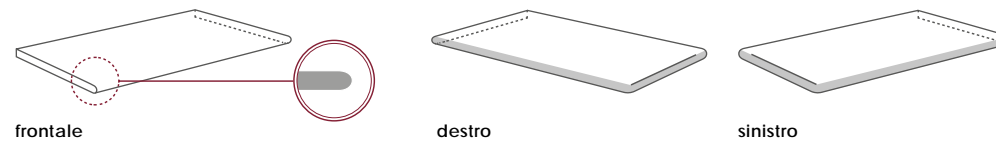

GRIGLIA 20MM GRIP RETTIFICATO

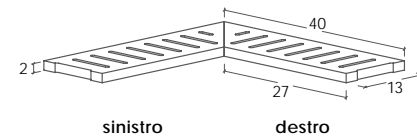
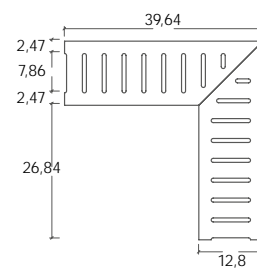
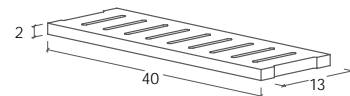

13x40x2 5,1"x16"x0,7" SINGOLO	4
13x40x2 5,1"x16"x0,7" ANGOLARE	1

* Il formato 30x60 rettificato è disponibile sulle serie
The rectified 30x60 size is available on the series /
Le format rectifié 30x60 est disponible sur la série /
Das rektifizierte Format 30x60 ist in der Serie erhältlich:
**Atlantis Grip - Blendstone Grip - Cementart Grip -
Cottage Grip - Garda Grip - Neutra Roc - Pangea Grip -
Pietre Pure Roc - Stonequarts Grip - Venexia Grip**

Il formato 40x120 rettificato è disponibile sulla serie
The rectified 40x120 size is available on the series /
Le format rectifié 40x120 est disponible sur la série /
Das rektifizierte Format 40x120 ist in der Serie erhältlich:
Arbor Grip - Badia Roc - Wooder Grip

A richiesta: tono e grafica abbinata sulla superficie frontale del pezzo
speciale gradone
On request: shade and graphics combined on the front surface of the
special step tile /
Sur demande, la couleur et le motif peuvent être assortis au nez de
marche /
Auf Anfrage: Passender Farbton und graphische Elemente auf der
Frontfläche des Formstücks Stufe



Certificazione LEED

LEED certification / Certification LEED / Zertifizierung LEED

IT / La certificazione LEED (Leadership in Energy and Environmental Design) è un sistema di certificazione sostenibilità aziendale ed energetica degli edifici applicato in oltre 140 paesi nel mondo, ha come scopo base la promozione e lo sviluppo di un approccio globale alla sostenibilità ambientale, sociale ed economica degli edifici, dalla fase di progettazione fino alla gestione quotidiana. Il metodo di certificazione prevede l'attribuzione di un punteggio all'edificio riconosciuto sulla base della verificata conformità dello stesso a diversi prerequisiti e crediti LEED.

Il gres porcellanato e/o Ecogres di Alfalux è un materiale LEED compliant, ovvero soddisfa i requisiti definiti dalla USGBC per i materiali e le risorse in termini di percentuale di materiale riciclato, effetti isolanti, basse emissioni inquinanti e proprietà innovative e di design. Ciò significa che l'impiego dei materiali Alfalux per pavimenti o rivestimenti consente l'assegnazione di un punteggio che concorrerà all'attribuzione della certificazione LEED.

EN / LEED (Leadership in Energy and Environmental Design) certification is a system for certifying company and energy sustainability of buildings, and is applied in over 140 countries in the world. It promotes and develops a global approach to environmental, social and economic sustainability of buildings, from the design phase right down to their daily management. This method of certification provides for assigning points to the building, worked out on the basis of its verified compliance with various LEED requirements and credits. Alfalux porcelain stoneware and Ecogres are LEED-compliant materials: that is, they meet the requirements defined by the USGBC for materials and resources in terms of percentage of recycled material, insulating effects, low polluting emissions and innovative and design properties. This means that the use of Alfalux materials for floors or wall tiling allows points to be assigned, that will contribute to giving LEED certification.

FR / La certification LEED (Leadership in Energy and Environmental Design) est un système de certification de la durabilité des bâtiments reconnu dans plus de 140 pays, son but fondamental est de promouvoir et développer une approche globale de la durabilité environnementale, sociale et économique des bâtiments, de la phase de conception à la gestion quotidienne. La méthode de certification prévoit l'attribution de points au bâtiment après vérification de sa conformité par rapport à différents critères et crédits LEED. Le grès cérame et/ou Ecogres d'alfalux est un matériau conforme au système LEED, c'est-à-dire qu'il respecte pleinement les critères définis par le USGBC pour les matériaux et les ressources, relatifs au pourcentage de matériaux recyclés, aux effets isolants, aux basses émissions polluantes, aux propriétés innovantes et au design. L'utilisation sur sols ou revêtements des matériaux alfalux donne ainsi droit à l'attribution de points qui contribueront à l'obtention de la certification LEED.

DE / Die Zertifizierung LEED (Leadership in Energy and Environmental Design) ist ein System für die Unternehmens- und Energienachhaltigkeit von Gebäuden, das in mehr als 140 Ländern der Welt angewandt wird. Es hat sie als Hauptziel die Förderung und Entwicklung eines globalen Ansatzes mit Bezug auf die umweltbezogene, soziale und wirtschaftliche Nachhaltigkeit der Gebäude, von der Projektphase bis zur täglichen Verwaltung. Die Zertifizierungsmethodik sieht eine Punkteverteilung an diejenigen Gebäude vor, die aufgrund von deren Überprüfung Konformität den verschiedenen Anforderungen und LEED-Krediten gegenüber anerkannt wurden. Das Steinzeug und/oder Ecogres von Alfalux ist ein LEED-konformes Material, das heißt, es erfüllt die von der USGBC für die Materialien und Ressourcen festgelegten Anforderungen im Hinblick auf die Prozentzahl der recycelten Materialien, die Isolierung, die niedrige Schadstoffemission und die innovativen und designbezogenen Eigenschaften. Daraus folgt, dass die Verwendung von Alfalux-Produkten für Fußböden oder Wandverkleidungen die Zuordnung einer Punktzahl erlaubt, die zur Vergabe der LEED-Zertifizierung beiträgt.

SCHEDE PUNTEGGIO

Points sheet / Fiche de points / Punkteverteilung

IT / SCHEDA PUNTEGGIO PRODOTTI ALFALUX
CONTRIBUTI ALL'OTTENIMENTO DEL PUNTEGGIO:

Contenuto di Materiale Riciclato (Credito MR 4.1): 2 punti LEED. Il 40% del materiale che costituisce i nostri prodotti contiene materiali crudi e cotti di riciclo (materiale pre-consumo)
Ottimizzazione della Performance Energetica (Credito EA 1): I prodotti ALFALUX concorrono ad accumulare crediti da 1 a 10 punti LEED.

Le piastrelle ceramiche essendo materiali a bassa conducibilità termica e soggette a bassissimi sbalzi termici, sono dotate di potere isolante e contribuiscono al risparmio energetico. I nostri prodotti sono particolarmente indicati per rivestimenti di facciate, ventilate e non, e per sistemi di riscaldamento a pavimento.

Contenuto di Composti organici volatili VOC (Credito EQ 4.3): 1 PUNTO LEED

Le piastrelle ceramiche, per la loro conformazione, sono a bassissima emissione di sostanze organiche volatili e pertanto rispettano la categoria di credito EQ 4.3 per la qualità ambientale interna.

EN / POINTS SHEET ALFALUX PRODUCTS
CONTRIBUTIONS TO OBTAINING POINTS:

Content of recycled material (credit MR 4.1): 2 LEED points The 40% of the material comprising our products contains recycled raw and fired materials (pre-consumer waste).
Optimization of energy performance (credit ea 1): ALFALUX products contribute to accumulating credits from 1 to 10 LEED points.

Ceramic tiles, being low thermal conductivity materials and subject to very low thermal excursions, have insulating properties and contribute to saving energy. Our products are particularly recommended for tiling facades, both ventilated and otherwise, and for underfloor heating systems.

VOC - Volatile Organic Compounds - content (credit eq 4.3): 1 LEED point

Ceramic tiles, because of their conformation, have very low emissions of volatile organic substances and therefore comply with credit category EQ 4.3 For indoor environmental quality.

FR / FICHE DE POINTS PRODUITS ALFALUX
CONTRIBUTIONS À L'OBTENTION DE POINTS:

Contenu Recyclé (crédit MR 4.1): 2 Points LEED

Le 40 % des matériaux entrant dans la composition de nos produits contient des matériaux recyclés crus et cuits (matériaux pré-consommation).

Optimisation de la Performance énergétique (crédit EA 1): les produits ALFALUX peuvent cumuler de 1 à 10 points LEED

Les carreaux en céramique, un matériau à basse conductibilité thermique sujet à de très faibles écarts thermiques, présentent des propriétés isolantes et contribuent à économiser les ressources énergétiques. Nos produits sont particulièrement indiqués en revêtement de paroi ventilée ou non, ainsi que pour les systèmes de chauffage au sol.

Contenu en COV (Composés Organique Volatils) (crédit EQ 4.3): 1 Point LEED

De par leur conformation, les carreaux en céramique présentent de très faibles émissions de composés organiques volatils.

DE / PUNKTEVERTEILUNG PRODUKTE ALFALUX
BEITRAG ZUR VERGABE VON PUNKTEN:

Gehalt von recyceltem Material (Kredit MR 4.1): 2 LEED-Punkte Das 40% des Materials, aus denen unsere Produkte bestehen, enthält gebranntes oder rohes Recyclingmaterial (pre-consumer material)

Optimierung der Energieleistung (Kredit EA 1): die Produkte ALFALUX tragen zur Sammlung von Krediten von 1 bis 10 LEED-Punkten bei

Als Materialien mit geringer Wärmeleitfähigkeit und grosser Temperaturwechselbeständigkeit sind Keramikfliesen mit Wärmedämmvermögen ausgestattet und tragen zur Energieersparnis bei. Unsere Produkte sind besonders geeignet für Fassadenverkleidungen mit oder ohne Hinterlüftung und für Fussboden-Heizsysteme

Gehalt von flüchtigen organischen Verbindungen VOC (Kredit EQ 4.3): 1 LEED-Punkt

Durch ihre Zusammensetzung haben Keramikfliesen sehr geringe Emissionen von flüchtigen organischen Verbindungen und entsprechen daher der Kreditkategorie EQ 4.3 für die interne Umweltqualität. Ils respectent à ce titre les exigences de la catégorie EQ 4.3 Pour la qualité des environnements intérieurs.



IT / Bios Ceramics®, è la più avanzata ed esclusiva generazione di ceramiche bioattive per applicazioni architettoniche, certificate ed ecocompatibili, con caratteristiche antibatteriche, autopulenti e di riduzione degli agenti inquinanti.

La produzione si articola nell'ambito di due trattamenti estremamente specializzati e continuamente soggetti a migliorie prestazionali, **Bios Self-Cleaning®** e **Bios Antibacterial®**, in grado di rispondere a qualsiasi esigenza applicativa in interni ed esterni, in funzione delle specifiche condizioni di impiego. Una proposta trasversale e diversificata che in oltre vent'anni di sperimentazione ha permesso di soddisfare la creatività di progettisti e clienti in tutto il mondo, grazie alle ricercate finiture e ai diversi formati disponibili su tutta la gamma prodotti di ALFALUX.

L'offerta comprende:

Bios Self-Cleaning®, lastre in gres porcellanato per la realizzazione di rivestimenti esterni di facciata. Grazie allo speciale trattamento basato sulla tecnologia **Hydrotect®**, in presenza di luce solare **Bios Self-Cleaning®** attiva una reazione in grado di abbattere non solo i batteri ma soprattutto gli inquinanti presenti nell'aria e decomporre lo sporco che si deposita sulla superficie delle piastrelle, in modo che venga rimosso dall'acqua piovana, grazie alla super-idrofilia della superficie ceramica.

Bios Antibacterial®, pavimenti e rivestimenti in gres porcellanato con assoluta proprietà antibatteriche, conformi alla regolamentazione europea, efficaci in qualsiasi condizione di luce, anche al buio, capaci di abbattere al 99,9% i principali ceppi batterici presenti sulle superfici: Escherichia coli, Pseudomonas aeruginosa, Staphylococcus aureus, Enterococcus faecalis.

CERAMICHE BIOATTIVE

Innovativa tipologia di prodotti eco-compatibili, in grado di interfacciarsi autonomamente con l'ambiente, per generare una serie di processi virtuosi, quali in particolare, reazioni di tipo chimico e biologico, capaci di ricadute positive in termini antibatterici, di abbattimento degli agenti inquinanti, di autopulibilità delle superfici e capaci di contribuire in maniera determinante all'innalzamento della qualità del microambiente (interno o esterno) in cui gli elementi ceramici vengono messi in opera. I processi avvengono grazie alla particolare natura dei materiali e dei trattamenti, senza alcuna necessità di alimentazione elettrica, energetica o del rinnovo dei composti necessari a sostenere nel tempo la reazione.
Bioactive ceramics

EN / Bios Ceramics® is the most advanced, exclusive range of bioactive ceramics for architectural applications, certified and eco-friendly, with anti-bacterial, self-cleaning and pollutant-reduction properties.

The range consists of two treatments, **Bios Self-Cleaning®** and **Bios Antibacterial®**, highly specialised and constantly subject to performance improvements, able to meet any interior or exterior application requirement according to the specific conditions of use. A cross-cutting and diversified range that, in over twenty years of experimentation, has enabled the creative demands of both designers and clients throughout the world to be fulfilled, thanks to its refined finishes and the different sizes available for the entire ALFALUX product range.

The range includes:

Bios Self-Cleaning® porcelain stoneware slabs for facade cladding. The special treatment based on **Hydrotect®** technology allows **Bios Self-Cleaning®** to activate a reaction in the presence of sunlight. This reaction reduces not only bacteria, but especially air pollutants, and decomposes dirt deposits on the tile surface, which are washed away by rainwater, thanks to the super-hydrophilicity of the ceramic surface.

Bios Antibacterial®, flooring and wall coverings in porcelain stoneware with certified antibacterial properties, complying with European regulations and effective in any light conditions, even in darkness, and able to remove up to 99.9% of the main bacterial strains to be found on surfaces: Escherichia coli, Pseudomonas aeruginosa, Staphylococcus aureus, Enterococcus faecalis.

BIOACTIVE CERAMICS

Innovative kind of environment-friendly products that can independently interface with the environment to create a number of virtuous processes, such as chemical and biological reactions that have an air pollutant reducing and antibacterial effect and trigger the self-cleaning of the surfaces, thus remarkably contributing to improving the quality of the (internal or external) micro-environment in which the ceramics are installed. Such processes take naturally place thanks to the materials and treatments, without any electricity or energy, and without having to renew the compounds necessary to prolong the reaction.

FR / Bios Ceramics® est une génération exclusive, la plus avancée, de céramiques bioactives destinées au secteur architectural, certifiées et éco-compatibles, aux propriétés antibactériennes et autonettoyantes en mesure de réduire également les polluants.

La production concerne deux traitements ultra-spécialisés, aux performances sans cesse améliorées, **Bios Self-Cleaning®** et **Bios Antibacterial®**, en mesure de répondre à toute exigence d'application, en extérieur comme en intérieur, en fonction des conditions spécifiques d'utilisation. Une offre transversale et diversifiée qui, en plus de vingt ans d'expérimentation, a permis de satisfaire la créativité de designers et de clients du monde entier, grâce aux finitions raffinées et aux différents formats disponibles sur toute la gamme de produits ALFALUX.

Cette offre comprend:

Bios Self-Cleaning®, dalles de grès cérame pour la réalisation de revêtements extérieurs de façade. Grâce à un traitement spécial basé sur la technologie **Hydrotect®**, **Bios Self-Cleaning®** déclenche, en présence de lumière solaire, une réaction capable d'éliminer non seulement les bactéries mais surtout les polluants présents dans l'air, de décomposer les saletés déposées en surface et de les éliminer grâce à l'eau de pluie et aux propriétés ultra-hydrophiles de la surface céramique.

Bios Antibacterial®, des sols et des revêtements en grès cérame dotés de propriétés antibactériennes élevées, conformes à la réglementation européenne, est efficace dans toutes les conditions de lumière, y compris dans l'obscurité, et permet d'éliminer 99,9 % des principales souches bactériennes présentes sur les surfaces : Escherichia coli, Pseudomonas aeruginosa, Staphylococcus aureus, Enterococcus faecalis.

DE / Bios Ceramics® ist die fortschrittlichste und exklusivste Generation an bioaktiven Keramikprodukten für zertifizierte und umweltgerechte Lösungen in der Architektur, mit antibakteriellen, selbstreinigenden und schadstoffreduzierenden Eigenschaften.

Die Produktion basiert auf **Bios Self-Cleaning®** und **Bios Antibacterial®**, zwei hochspezialisierten Behandlungen, die konstanten Leistungsverbesserungen unterliegen und je nach Einsatzbedingungen allen Arten von Anwendungen im Innen- und Außenbereich gerecht werden. Ein transversales und vielfältiges Angebot, das in über zwanzig Jahren, die ganz im Zeichen des Experimentierens standen, die Kreativität von Planern und Kunden weltweit dank der ausgesuchten Oberflächenbearbeitungen und der unterschiedlichen Formate des Gesamtangebots von ALFALUX a zufriedenstellen.

Das Angebot umfasst:

Bios Self-Cleaning®, Platten aus Feinsteinzeug für den Bau von Fassaden-Außenverkleidungen. Dank der Spezialbehandlung auf Grundlage der **Hydrotect®**-Technologie ruft **Bios Selfcleaning®** im Sonnenlicht eine Reaktion hervor, die die vorhandene Luftverschmutzung bindet und den sich auf den Fliesenoberflächen absetzenden Schmutz zersetzt. Dieser kann dann in der Folge dank der super-hydrophilen Keramikoberfläche vom Regenwasser abgewaschen werden.

Bios Antibacterial®, Bodenbeläge und Wandverkleidungen aus Feinsteinzeug mit herausragenden antibakteriellen Eigenschaften, die den europäischen Regelungen entsprechen, unter allen Lichtverhältnissen - auch im Dunkeln - wirksam sind und bis zu 99,9 % der hauptsächlich auf Oberflächen auftretenden Bakterienstämme abtöten können: Escherichia coli, Pseudomonas aeruginosa, Staphylococcus aureus, Enterococcus faecalis.

bios self-cleaning®

IT / Una soluzione innovativa per i rivestimenti di facciata, in grado di qualificare gli involucri architettonici con elevate prestazioni di autopulizia e di abbattimento degli agenti inquinanti.

EN / An innovative façade cladding solution that ensures high self-cleaning and pollution abatement performance for architectural envelopes.

FR / Une solution innovante pour les revêtements de façade, en mesure de donner aux enveloppes architecturales d'excellentes performances d'autonettoyage et d'élimination des agents polluants.

DE / Eine innovative Lösung für Fassadenverkleidungen, die Gebäudehüllen durch verbesserte selbstreinigende Eigenschaften und die Fähigkeit zum Abbau von Schadstoffen aufwertet.

PROPRIETÀ SUPER IDROFILE

Super-hydrophilic properties / Propriété super-hydrophile / Super hydrophile Eigenschaften



Lastra ceramica tradizionale
Traditional ceramic slab /
Dalle céramique ordinaire /
Traditionelle Keramikplatte

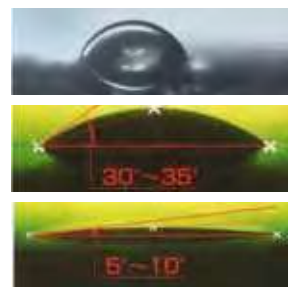

Lastra ceramica trattata Bios Self-Cleaning®
Bios Self-Cleaning® ceramic slab /
Dalle céramique traitée avec
Bios Self-Cleaning® /
Mit Bios Self-Cleaning® behandelte
Keramikplatte

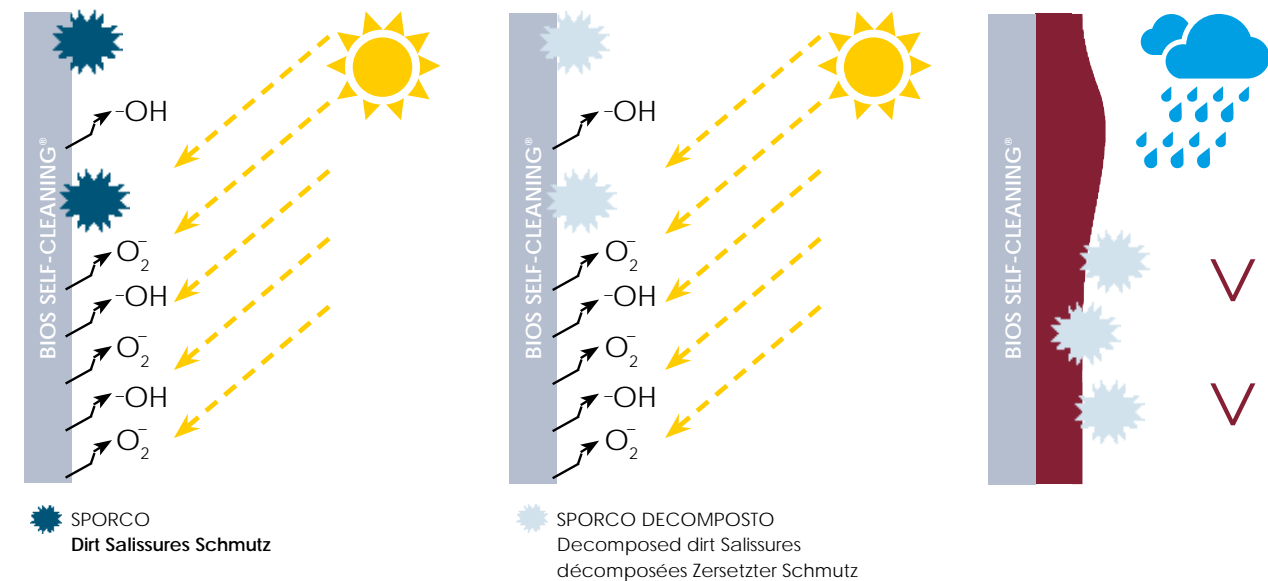

Quando la luce del sole (raggi UVA) irradia la superficie di **Bios Self-Cleaning®** si genera ossigeno attivo (O₂⁻, -OH)

When sunlight (UVA rays) hits the surface of the **Bios Self-Cleaning®**, active oxygen (O₂⁻, -OH) forms

La lumière du soleil (rayons UVA) qui rayonne sur la surface de **Bios Self-Cleaning®** génère de l'oxygène actif (O₂⁻, -OH)

Wenn das Sonnenlicht (UVA-Strahlen) die Oberflächen von **Bios Self-Cleaning®** bestrahlt, wird Aktivsauerstoff erzeugt (O₂⁻, -OH)

L'ossigeno attivo (O₂⁻, -OH) decompone lo sporco in sostanze meno aderenti

Active oxygen (O₂⁻, -OH) decomposes dirt into less adhesive substances

L'oxygène actif (O₂⁻, -OH) décompose les salissures en substances moins adhérentes

Der Aktivsauerstoff (O₂⁻, -OH) zersetzt den Schmutz in weniger haftfähige Stoffe

L'acqua piovana si espande sulla superficie di **Bios Self-Cleaning®** generando un sottilissimo strato che deterge ed elimina lo sporco precedentemente decomposto dall'ossigeno attivo.

Rainwater spreads onto the **Bios Self-Cleaning®** surface, forming an extremely thin layer that cleanses and removes the dirt that has been decomposed by the active oxygen.

L'eau de pluie glisse sur la surface de **Bios Self-Cleaning®** en constituant une fine couche d'eau qui nettoie et élimine les salissures précédemment décomposées par l'oxygène actif.

Das Regenwasser breitet sich auf der Oberfläche von **Bios Self-Cleaning®** aus und erzeugt einen hauchdünnen Film, der den zuvor vom Aktivsauerstoff zersetzten Schmutz reinigt und beseitigt.

bios self-cleaning®

IT / LA TECNOLOGIA HYDROTECT®

La tecnologia **Hydrotect®** viene utilizzata su licenza da oltre 100 produttori di tutto il mondo, nei più differenti settori applicativi, dall'industria automobilistica alle costruzioni. Detentore del brevetto è il gruppo giapponese toto, leader globale nel settore delle tecnologie fotocatalitiche, con il quale Casalgrande Padana ha sottoscritto un master agreement. Grazie a questa tecnologia le ceramiche **Bios Self-cleaning®** utilizzate nei rivestimenti di facciata ed involucri ventilati, offrono significative risposte in termini di capacità autopulente e di abbattimento dei NOx (ossidi e miscele di azoto, tra i principali inquinanti dell'atmosfera urbana). In particolare, **Bios Self-cleaning®** aggiunge alle caratteristiche estetiche e prestazionali dei rivestimenti ceramici in grès porcellanato, il drastico abbattimento degli interventi di pulizia e manutenzione delle superfici, garantendo un sensibile risparmio in termini economici e il mantenimento delle qualità e dell'aspetto del manufatto architettonico.

Le caratteristiche bioattive per i rivestimenti esterni L'esclusiva formulazione di **bBios Self-cleaning®** è a base di Biossido di titanio (tio₂), una sostanza naturale, non nociva, tradizionalmente utilizzata come pigmento bianco e per confezionare additivi alimentari, dentifrici, prodotti cosmetici eccetera.

Il Biossido di titanio conferisce alle superfici **Bios Self-cleaning®**:

- Caratteristiche fotocatalitiche che, in presenza di irraggiamento luminoso, consentono di decomporre le sostanze organiche e gli inquinanti depositati sulle piastrelle, garantendo proprietà autopulenti e di purificazione dell'aria.
- Caratteristiche di super-idrofilia, che ne esaltano la capacità di auto detergersi. Tanto è maggiore l'irraggiamento con luce UV della superficie trattata, tanto diminuisce il suo angolo di contatto con l'acqua, che tende addirittura a zero dopo un ragionevole intervallo di tempo. L'acqua si spande e dilava con facilità. In pratica, all'azione del Biossido di titanio che disgrega i depositi organici presenti sulla superficie trattata, grazie alla fotocatalisi, si aggiunge quella idrofila, che consente all'acqua piovana di detergere le piastrelle, asportando le macchie dalla loro superficie.

EN / HYDROTECT® TECHNOLOGY

The **Hydrotect®** technology has been licensed out to over 100 manufacturers all over the world in the most diverse areas of application, from car-making to building. The owner of the patent is the Japanese holding toto, a global leader in photocatalytic technology, with which it has entered into a master agreement.

With the **Hydrotect®** technology, the **Bios Self-cleaning®** ceramics in facings and ventilated walls provide important responses through their Self-cleaning and NOx-reduction properties (NOx are nitrogen oxides and compounds, largely responsible for urban air pollution). In particular, **Bios Self-cleaning®** can combine the well-known aesthetic features and performance of unglazed stoneware ceramic facings with a dramatic reduction in the need to clean or maintain the surfaces, which translates into remarkable savings and a long-lasting quality and appearance of the architectural features.

Bioactive properties for exterior facings

The exclusive formulation of **Bios Self-cleaning®** contains titanium dioxide (tio₂), a natural substance traditionally used as a white pigment and to make food additives, toothpaste, makeup and so on. Because of its titanium dioxide content, **Bios Self-cleaning®** can perform to the highest standards, especially as a facing, to which it adds:

- Photo-catalytic properties, which, when triggered by light, can break up the organic substances and pollutants on the tile surface for a Self-cleaning, air cleansing effect.
- Super-hydrophilic properties, which make the most of its Self-cleaning properties. The higher the UV light on the treated surface, the smaller its angle of contact with water, which after a reasonable time is next to zero. This means that the water will easily spread and wash off. Basically, the effect of the titanium dioxide that breaks up the organic matter on the treated surface is supported, through photocatalysis, by the hydrophilic effect, whereby rainwater washes off any stain from the tile surface.

FR / LA TECHNOLOGIE HYDROTECT®

Plus de 100 fabricants dans le monde entier utilisent, sous licence, la technologie **Hydrotect®**, ceci dans les secteurs les plus variés, de l'industrie automobile au bâtiment. Le groupe japonais toto est titulaire du brevet et leader mondial dans le secteur des technologies photocatalytiques. Nous avons signé un master agreement avec le groupe toto. Grâce à la technologie **Hydrotect®**, les céramiques **Bios Self-cleaning®**, utilisées pour les revêtements de façades traditionnelles et/ou ventilées, offrent des réponses significatives en termes de capacité autonettoyante et d'abattement des NOx (oxydes et mélanges d'azote, parmi les principaux polluants de l'air en milieu urbain). En particulier, **Bios Self-cleaning®** est en mesure d'allier les caractéristiques esthétiques et les performances des revêtements céramiques en grès cérame, à une importante diminution des opérations d'entretien et de nettoyage des surfaces, en garantissant pendant de longues années des économies en termes de coûts et du maintien de la qualité et de l'aspect du bâtiment.

Les caractéristiques bioactives pour les revêtements d'extérieur La formule exclusive de **Bios Self-cleaning®** est à base de dioxyde de titane (tio₂), une substance naturelle, couramment utilisée en tant que pigment blanc mais aussi pour fabriquer des additifs alimentaires, dentifrices, produits cosmétiques, etc. Grâce au dioxyde de titane, **Bios Self-cleaning®** est en mesure de garantir d'excellentes prestations, notamment comme revêtement de façade, en conférant à celle-ci:

- Des caractéristiques photocatalytiques, qui en présence d'un rayonnement lumineux, permettent de décomposer les substances organiques et les polluants qui se déposent sur la surface des carreaux, en garantissant des propriétés autonettoyantes et de purification de l'air.
- Des caractéristiques super-hydrophiles qui exaltent les propriétés autonettoyantes. Plus le rayonnement UV sur la surface traitée est intense, plus l'angle de contact entre l'eau et la surface diminue, et peut même arriver à zéro après un certain laps de temps. Ainsi, en glissant sur la surface, l'eau la nettoie plus facilement. En pratique, l'action photocatalytique du dioxyde de titane dégrade les dépôts organiques présents sur la surface traitée, et conjuguée aux propriétés hydrophiles, l'eau de pluie nettoie les carreaux en éliminant ainsi les salissures.

DE / DIE HYDROTECT®-TECHNOLOGIE

Die Technologie **Hydrotect®** wird unter Lizenz von mehr als 100 Produzenten in aller Welt verwendet und zwar in unterschiedlichsten Anwendungsbereichen, von der Automobilindustrie bis zum Bauwesen. Der Patentinhaber ist der japanische Konzern toto, das weltweit führende Unternehmen im Bereich der fotokatalytischen Technologien, mit uns ein Master Agreement abgeschlossen hat.

Dank der Hydrotect® Technologie bieten die für die Gestaltung von Fassaden und hinterlüfteten Fassaden verwendeten Keramikprodukte **Bios Self-cleaning®** bedeutende Lösungen in puncto selbstreinigende Fähigkeit und NOx-Abbau (Oxide und Stickstoffmischungen, die zu den Hauptschadstoffen der Stadtluft gehören). Insbesondere ist **Bios Self-cleaning®** in der Lage, die schon bekannten ästhetischen Eigenschaften und Leistungen der keramischen Feinsteinzeugbeläge mit einer drastischen Reduzierung der Reinigungs- und Instandhaltungseingriffe an den Oberflächen zu bereichern und garantiert dabei über viele Jahre hinweg eine merkbare Kosteneinsparung und das Aufrechterhalten der Vorzüge und des Erscheinungsbildes der architektonischen Struktur.

Bioaktive Eigenschaften für externe Verkleidungen Die exklusive Formel von **Bios Self-cleaning®** baut auf Titandioxyd (tio₂) auf, ein natürlicher Stoff, der traditionell als weißes Pigment verwendet wird und für die Zubereitung von Lebensmittelzusatzstoffen, Zahnpasta, Kosmetika, usw. Dank Titandioxyd garantiert **Bios Self-cleaning®** ausgezeichnete Leistungen und verleiht besonders als Fassadenverkleidung folgende Eigenschaften:

- Fotokatalytische Eigenschaften, die bei Lichteinfall die Zersetzung der organischen Stoffe und der auf der Fliesenoberfläche abgesetzten Schadstoffe ermöglichen und Eigenschaften der Selbstreinigung und Luftreinigung garantieren.
- Super hydrophile Eigenschaften, welche die selbstreinigende Fähigkeit zusätzlich betont. Je größer die UV-Strahlung der behandelten Oberfläche, umso kleiner wird ihr Kontaktwinkel mit dem Wasser, der nach einem vernünftigen Zeitintervall sogar zum Nullwert neigt. Das bedeutet, dass sich das Wasser leicht ausbreitet und spült. Praktisch wird die Wirkung von Titandioxyd, das die organischen Ablagerungen an der behandelten Oberfläche zersetzt, dank der Fotokatalyse mit einer Hydrophilen Wirkung bereichert, mit der das Regenwasser die Fliesen reinigen und die Flecken von den Oberflächen entfernen kann.

bios antibacterial®

IT / Bios Antibacterial® è la linea di pavimenti e rivestimenti in gres porcellanato, conforme al Regolamento Europeo sui Biocidi (EU BPR 528/2012)*, capaci di abbattere al 99,9% i quattro principali ceppi batterici sulle superfici: Staphylococcus aureus, Escherichia coli, Pseudomonas aeruginosa, Enterococcus faecalis.

La tecnologia di **Bios Antibacterial®** sfrutta le caratteristiche dell'argento, materiale nobile ampiamente utilizzato nella produzione di oggetti d'uso quotidiano (posate, teiere, monete, monili), le cui proprietà antibatteriche sono note sin dall'antichità.

Un materiale assolutamente innocuo per la salute, anallergico a contatto con la pelle, che non rilascia sostanze nocive.

Bios Antibacterial® è attivo sempre, in qualsiasi condizione di luce, anche al buio assoluto.

*Il regolamento BPR sui biocidi concerne l'immissione sul mercato e l'uso di biocidi, utilizzati per la tutela dell'uomo, degli animali, dei materiali o degli articoli contro organismi nocivi, quali parassiti o batteri, mediante l'azione dei principi attivi contenuti nel biocida.

Il testo è stato adottato il 22 maggio 2012 ed è applicato dal 1 settembre 2013.

Secondo il regolamento BPR in vigore i prodotti antibatterici che non sono conformi alla regolamentazione in esso contenuta non possono essere immessi nel mercato europeo.

EN / Bios Antibacterial® This is the range of porcelain stoneware flooring and wall coverings complying with the European Regulation on Biocides (EU BPR 528/2012)*, able to remove up to 99.9% of the four main bacterial strains to be found on surfaces: Staphylococcus aureus, Escherichia coli, Pseudomonas aeruginosa, Enterococcus faecalis.

Bios Antibacterial® technology exploits the characteristics of silver, a noble material widely used in the production of articles in everyday use (cutlery, teapots, coins, jewellery), whose antibacterial properties have been known since ancient times. A material that is completely harmless to the health and hypoallergenic in contact with the skin, and does not release toxic substances.

Bios Antibacterial® is always active in any light conditions, even in total darkness.

*The BPR regulation on biocides concerns the placing on the market and use of biocidal products, which are used to protect humans, animals or articles against harmful organisms like pests or bacteria, by the action of the active substances contained in the biocidal product.

The text was adopted on 22 May 2012 and has been applicable since 1 September 2013.

According to the BPR regulation in force, antibacterial products that do not comply with the rules contained in it cannot be placed on the European market.

FR / Bios Antibacterial® est la ligne de sols et de revêtements en grès cérame, conforme au Règlement européen sur les produits biocides (EU BPR 528/2012)*, en mesure d'éliminer 99,9 % des quatre principales souches bactériennes présentes sur les surfaces : Staphylococcus aureus, Escherichia coli, Pseudomonas aeruginosa, Enterococcus faecalis.

La technologie **Bios Antibacterial®** exploite les caractéristiques de l'argent, matériau noble largement utilisé dans la production d'objets de la vie quotidienne (couverts, théières, pièces de monnaie, bijoux), dont les propriétés antibactériennes sont connues depuis l'Antiquité. Un matériau absolument inoffensif pour la santé, hypoallergénique au contact de la peau, qui ne produit aucune substance nocive.

Bios Antibacterial® est toujours actif, quelles que soient les conditions d'éclairage, y compris dans l'obscurité la plus complète.

*Le règlement RPB sur les produits biocides concerne la mise sur le marché et l'usage de produits contenant des substances biocides. Ces produits sont utilisés pour protéger les êtres humains, les animaux, les matériaux ou les articles contre les organismes nuisibles tels que les parasites ou les bactéries, grâce à l'action des substances actives contenues dans le produit biocide.

Le texte, adopté le 22 mai 2012, a été appliqué à partir du 1er septembre 2013. Selon le règlement RPB en vigueur, les produits antibactériens qui n'y sont pas conformes ne peuvent pas être mis sur le marché européen.

DE / Bios Antibacterial® ist die Linie der Bodenbeläge und Wandverkleidungen aus Feinsteinzeug, die die Europäische Verordnung über Biozidprodukte (EU BPR 528/2012)* erfüllt, welche bis zu 99,9 % der vier hauptsächlichsten auf Oberflächen auftretenden Bakterienstämme abtöten können: Staphylococcus aureus, Escherichia coli, Pseudomonas aeruginosa, Enterococcus faecalis.

Die Technologie von **Bios Antibacterial®** nutzt die Eigenschaften von Silber, einem edlen Material, das in der Herstellung von Alltagsgegenständen (Besteck, Teekannen, Münzen, Schmuckstücke) eine breite Anwendung findet und dessen antibakterielle Eigenschaften bereits in der Antike bekannt waren.

Ein absolut nicht gesundheitsschädliches Material, das bei Hautkontakt anallergisch ist und keine Schadstoffe freisetzt. **Bios Antibacterial®** ist immer aktiv, unter allen Lichtverhältnissen, auch bei völliger Dunkelheit.

* Die Verordnung über Biozidprodukte (BPR) regelt das Inverkehrbringen und die Verwendung von Biozidprodukten, die aufgrund der Aktivität der in ihnen enthaltenen Wirkstoffe zum Schutz von Mensch, Tier, Materialien oder Erzeugnissen vor Schadorganismen, wie Schädlingen oder Bakterien, eingesetzt werden.

Der Wortlaut wurde am 22. Mai 2012 angenommen und ist seit 1. September 2013 gültig.

Nach der geltenden BPR-Verordnung können antibakterielle Produkte, die nicht der Regelung entsprechen, in Europa nicht in Verkehr gebracht werden.



<https://echa.europa.eu/it/regulations/biocidal-products-regulation/understanding-bpr>

bios antibacterial®

IT / CAUSE ED EFFETTI DEI BATTERI NEGLI AMBIENTI

Lo Staphylococcus aureus, l'Escherichiacoli, lo Pseudomonas aeruginosa e l'Enterococcus faecalis, sono i principali responsabili delle infezioni che si registrano in ambito ospedaliero e sono stati adottati come indicatori standard perché rappresentano la categoria più aggressiva, in alcuni casi super resistente anche agli antibiotici.

QUANDO UN PRODOTTO PUÒ DEFINIRSI ANTIBATTERICO

Dopo severe prove di laboratorio, **Bios Antibacterial®** è risultato altamente efficace, in quanto capace di abbattere del 99,9% i quattro principali ceppi batterici presenti negli ambienti confinati: Staphylococcus aureus, Enterococcus faecalis, Escherichia coli, Pseudomonas aeruginosa.

Nella pratica il 100% di antibattericità non può essere assicurato, la soglia di efficacia è stata quindi fissata dai ricercatori di tutto il mondo a oltre il 90%, perché solo a questi livelli si può registrare una riduzione realmente significativa dei batteri. Per questo motivo, in termini di efficacia antibatterica, la comunità scientifica non prende in considerazione valori inferiori alla soglia del 90% e i prodotti che non raggiungono questo livello non possono essere definiti antibatterici.

La ricerca ha inoltre evidenziato che **Bios Antibacterial®** in presenza di umidità, tradizionale terreno fertile per lo sviluppo della flora batterica, vede addirittura amplificare i propri effetti benefici. Va comunque evidenziato come la tecnologia **Bios Antibacterial®**, pur essendo capace di abbattere al 99,9% i 4 principali ceppi batterici presenti negli ambienti e ridurre la crescita virale, non possa garantire in assoluto l'immunità da infezioni. Si consiglia pertanto, in funzione delle specifiche destinazioni d'uso degli ambienti, di sottoporre le superfici ad appropriati cicli di pulizia e disinfezione.

LE PROPRIETÀ ANTIODORE

I cattivi odori sono tra le cause più invalidanti della qualità degli ambienti, oltre che segnale tangibile di bassi livelli di igiene dell'aria e delle superfici. Nei locali bagno i cattivi odori vengono generati dalla combinazione tra urea, germi e batteri, che producono ammoniaca e trimetilammina. Effetti analoghi possono attivarsi nelle cucine, causati dalla reazione con microresidui organici. Inoltre, sempre nei bagni e a bordo piscina la concentrazione di sebo e residui cutanei, in combinazione con i germi, dà luogo alla formazione di macchie e depositi viscosi che, oltre al degrado nell'aspetto dei rivestimenti, possono ridurre le caratteristiche antiderapanti delle superfici e la sicurezza al calpestio. In tutti questi casi, l'effetto antibatterico di **Bios Antibacterial®**, aiuta a eliminare i cattivi odori e a mantenere valide le caratteristiche antiderapanti delle piastrelle anche in assenza totale di luce, offrendo garanzie nel più ampio spettro.

Le prestazioni di **Bios Antibacterial®** sono conformi al regolamento europeo sui biocidi (BPR) e sono state verificate e certificate dal Dipartimento di scienze biomediche, sezione di microbiologia, dell'Università di Modena e Reggio Emilia e il Dipartimento di Farmacia e Biotecnologie dell'Università di Bologna.

EN / CAUSES AND EFFECTS OF BACTERIA IN THE ENVIRONMENT

Staphylococcus aureus, Escherichia coli, Pseudomonas aeruginosa and Enterococcus faecalis are largely responsible for hospital-acquired infections and have been taken as standard indicators, because they are the most aggressive class of bacteria, which sometimes can even be resistant to antibiotics.

WHEN A PRODUCT CAN BE CALLED ANTIBACTERIAL

After strict lab tests, **Bios Antibacterial®** turned out to be extremely effective, as it can remove 99.9% of the main four bacterial strains living in confined areas: Staphylococcus aureus, Enterococcus faecalis, Escherichia coli, Pseudomonas aeruginosa.

As a matter of fact, a 100% anti-bacterial effect cannot be ensured, so the effectiveness threshold has been set by researchers all over the world at over 90%, because only at such levels can a really significant reduction in bacteria be measured. That's why in terms of antibacterial effectiveness the scientific community will not take into account any rating under 90% and products that fail to achieve such level may not be called antibacterial.

In addition, research has shown that **Bios Antibacterial®** in a humid environment, which is traditionally a fertile ground for the growth of bacterial flora, its beneficial effects are even greater. Note, however, that, even if capable of removing 99.9% of the 4 main bacterial strains living in the environment and reducing viral growth, the **Bios Antibacterial®** technology cannot ensure perfect immunity to infections. Therefore, depending on the way a place is to be used, the surfaces should be treated with appropriate cleaning and disinfection procedures.

DEODORISING PROPERTIES

Bad smells are some of the factors that most deteriorate the quality of an environment, as well as being a tangible sign of a low level of air and surface hygiene. In bathrooms, bad smells are generated by a combination of urea, germs and bacteria that produce ammonia and trimethylamine. Similar effects may be had in kitchens as a reaction with organic micro-residues. In addition, also in bathrooms or poolside, a concentration of sebum and shed skin cells, combined with germs, forms stains and slippery spots that, as well as deteriorating the appearance of a facing, may reduce the anti-slipping properties of the surfaces and their safety when walked over. In all these cases, the antibacterial effect of **Bios Antibacterial®** helps remove bad smells and retain the anti-slipping properties of the tiles, for perfect safety.

Bios Antibacterial® performances comply with the European regulation on biocides (BPR) and have been verified and certified by the Department of Biomedical Sciences, Microbiology section, of the University of Modena and Reggio Emilia, and the Department of Pharmacy and Biotechnologies of the University of Bologna.

bios antibacterial®

FR / CAUSES ET EFFETS DES BACTÉRIES DANS LE MILIEU AMBIANT

Le Staphylococcus aureus, l'Escherichia coli, le Pseudomonas aeruginosa et l'Enterococcus faecalis sont les principaux responsables des infections enregistrées en milieu hospitalier. Ils ont été adoptés comme indicateurs standard car ce sont les souches les plus agressives, dans certains cas même résistantes aux antibiotiques.

QUAND UN PRODUIT PEUT ÊTRE DÉFINI COMME ANTIBACTÉRIEN

Après de rigoureux essais en laboratoire, **Bios Antibacterial®** résulte extrêmement efficace, étant capable d'abattre 99,9% des quatre principales souches bactériennes présentes dans les espaces fermés : Staphylococcus aureus, Enterococcus faecalis, Escherichia coli, Pseudomonas aeruginosa. Dans la pratique, étant difficile d'assurer des propriétés 100% antibactéricides, la communauté scientifique mondiale a fixé le seuil d'efficacité à plus de 90%, car c'est seulement à ce niveau que l'on peut enregistrer une réduction vraiment significative des bactéries. Pour cette raison, il faut souligner qu'en termes d'efficacité antibactérienne, la communauté scientifique ne prend même pas en considération les valeurs inférieures à 90%, et donc les produits qui n'atteignent pas cette limite ne peuvent en aucun cas être définis comme antibactériens. La recherche a également montré que **Bios Antibacterial®** en présence d'humidité, facteur propice au développement de la flore bactérienne, ses effets bénéfiques augmentent ultérieurement. Il faut souligner que même si la technologie **Bios Antibacterial®** est capable d'abattre 99,9% des 4 principales souches bactériennes et de réduire leur croissance, elle ne peut toutefois garantir une immunité totale contre les infections. Il est donc conseillé, en fonction de chaque contexte d'utilisation spécifique, de soumettre les surfaces à des cycles de nettoyage et de désinfection adéquats.

LES PROPRIÉTÉS ANTI-ODEURS

Les mauvaises odeurs sont une des causes qui nuisent le plus à la qualité de l'air et sont aussi le signe tangible du bas niveau d'hygiène de l'air et des surfaces. Dans les salles de bains, les mauvaises odeurs sont générées par la combinaison entre l'urée, les germes et les bactéries, qui produisent de l'ammoniac et de la triméthylamine. Des effets analogues peuvent se produire en cuisine, dus à la réaction avec des micro résidus organiques. Par ailleurs, en salle de bains ou sur le bord des piscines, la concentration de sébum et de résidus cutanés, en combinaisons aux germes, donne lieu à la formation de taches et de dépôts visqueux, qui outre à dégrader l'aspect des revêtements, peuvent réduire les caractéristiques antiglisse des surfaces, et donc la sécurité des personnes. L'effet antibactérien de **Bios Antibacterial®** aide toujours à éliminer les mauvaises odeurs et à préserver les caractéristiques antiglisse des carreaux, en offrant des garanties à large spectre.

Les performances de **Bios Antibacterial®**, conformes au règlement européen sur les produits biocides (RPB), ont été vérifiées et certifiées par le Département des sciences biomédicales, section microbiologie de l'Université de Modène et de Reggio Emilia, et par le Département de pharmacie et de biotechnologies de l'Université de Bologne.

DE / URSACHEN UND AUSWIRKUNGEN VON BAKTERIEN IN RÄUMEN

Die Staphylococcus aureus, Escherichia coli, Pseudomonas aeruginosa und Enterococcus faecalis sind die Hauptverantwortlichen der Infektionen, die sich in Krankenhausbereichen ereignen und wurden als Standard-Anzeiger übernommen, da sie die aggressivste Kategorie darstellen, die in einigen Fällen sogar gegen Antibiotika resistent ist.

WANN KANN EIN PRODUKT ALS ANTIBAKTERIELL BEZEICHNET

Werden Nach strengen Labortests hat sich **Bios Antibacterial®** als höchst wirksam erwiesen, da das Produkt die vier in angrenzenden Bereichen vorhandenen wichtigsten Bakterienstämme zu 99,9% abbaut: Staphylococcus aureus, Enterococcus faecalis, Escherichia coli, Pseudomonas aeruginosa. In der Praxis kann eine zu 100% bakterientötende Wirkung nicht zugesichert werden, sodass die Wirksamkeitsschwelle von den Forschern aller Welt auf über 90% festgelegt wurde, denn nur in diesem Ausmaß kann eine wirklich bedeutende Reduzierung der Bakterien festgestellt werden. Aus diesem Grund berücksichtigt die wissenschaftliche Gemeinschaft in Hinsicht auf die antibakterielle Wirksamkeit keine Werte unter 90% und Produkte, die dieses Niveau nicht erreichen, können nicht als antibakteriell bezeichnet werden. Die Forschung hat außerdem festgestellt, **Bios Antibacterial®** bei Feuchtigkeit, einem bekanntlich begünstigenden Zustand für die Entwicklung von Bakterienflora, die vorteilhaften Wirkungen sogar noch verstärkt. Es ist auf jeden Fall zu sagen, dass die Technologie **Bios Antibacterial®** trotz ihrer Fähigkeit, die 4 wichtigsten in der Umgebung vorhandenen Bakterienstämme zu 99,9% abzubauen und die Virenwucherung zu reduzieren, die Immunität gegenüber Infektionen nicht absolut garantieren kann. Deshalb wird empfohlen, auf den Oberflächen in Funktion der spezifischen Einsatzbedingungen der Räume angemessenen Reinigungs- und Desinfektionszyklen vorzunehmen.

DIE GERUCHHEMMENDEN EIGENSCHAFTEN

Schlechte Gerüche gehören zu den Ursachen, die der Qualität der Räume am meisten schaden und sind außerdem ein offensichtliches Zeichen geringer Hygieneniveaus in der Luft und auf den Flächen. Im Badezimmer werden schlechte Gerüche von der Kombination zwischen Urin, Keimen und Bakterien verursacht, die Ammoniak und Trimethylamin erzeugen. Gleiche Folgen können sich in Küchen durch die Reaktion mit organischen Mikrorückständen ergeben. Außerdem bilden sich in Badezimmern und an Schwimmbadrändern durch die Konzentration von Hauttalg und Hautrückständen in Kombination mit Keimen Flecken und schlüpfrige Ablagerungen, die nicht nur die Auskleidungen unschön machen, sondern auch die rutschhemmenden Eigenschaften der Oberflächen und die Trittsicherheit reduzieren. In allen diesen Fällen hilft die antibakterielle Wirkung von **Bios Antibacterial®**, die schlechten Gerüche zu beseitigen und die rutschhemmenden Eigenschaften der Fliesen zu bewahren, und bietet deshalb eine Garantie in einem ganz breiten Spektrum.

Die Leistungen von **Bios Antibacterial®** entsprechen der Europäischen Verordnung über Biozidprodukte (BPR) und wurden vom Fachbereich Biomedizinische Wissenschaften, Sektion Mikrobiologie, der Universität Modena und Reggio Emilia sowie dem Fachbereich Pharmazie und Biotechnologie der Universität Bologna (Italien) getestet und zertifiziert.

Massetto di sottofondo e giunti

Foundation base and joints / Base en ciment et joints / Estrich und dehnungsfugen

IT / Per superfici da pavimentare molto estese, consigliamo di prestare attenzione alla progettazione delle strutture di sottofondo.

Infatti sono da tener conto le seguenti problematiche:

1. la dilatazione termica;
2. la deformazione o fessurazione dovute al ritiro e scioglimento dei materiali;
3. l'assestamento della struttura. Sottofondi posati in opera su strati comprimibili, esempio isolanti termici, vermiculite o argilla espansa, devono essere armati con rete elettrosaldata. I massetti possono essere eseguiti in due modi: galleggianti o aderenti. Nel primo caso occorre predisporre una barriera al vapore (foglio polietilico) quindi polistirolo di 1 cm lungo i muri perimetrali e lungo qualsiasi altro elemento che attraversa la pavimentazione. I giunti di frazionamento sono consigliati ogni 5x5 m. Nel caso di massetti aderenti occorre pulire la superficie cementizia, quindi applicare una boiaccia di adesione realizzata con cemento, acqua e idonei lattici.

Quando quest'ultima è ancora fresca occorre gettare il nuovo massetto aderente.

Le informazioni contenute in questo paragrafo sono puramente indicative. Per notizie più approfondite rimandiamo a documentazione specializzata.

EN / For very large floor surfaces we recommend additional care in the design of the foundation structure. The following factors should be kept in mind:

1. Thermal expansion.
2. Deformation or cracking caused by shrinkage and drying of the materials.
3. The settling of the structure. Foundations laid on compressible layers, like thermal insulation, vermiculite, or expanded clay must be reinforced with arc-welded meshwork. The base can be made in one of two ways: floating or fixed. In the first case a vapour barrier must be provided (polyethylene sheet) and then polystyrene of 1 cm along the perimeter walls and along any other element that runs across the floor. Sectional joints are recommended every 5 x 5 m. In the case of fixed bases, clean the cement surface and apply a fixing grout made from cement, water and suitable latex. When this is still fresh, cast the new fixed laying base. The information contained in this paragraph is purely indicative.

For more-in-depth information, we refer you to the special documentation.

FR / Si vous devez carreler des surfaces très étendues, nous vous conseillons de faire très attention au projet des structures de la base en ciment.

Il existe, en effet, des problèmes dont vous devez tenir compte:

1. la dilatation thermique ;
2. la déformation ou les fissures provoquées par le retrait et le séchage des matériaux ;
3. le tassement de la structure. Les bases qui sont posées sur des couches compressibles comme, par exemple, des couches d'isolation thermique, de la vermiculite ou de l'argile expansée, doivent être armées de filets soudés électriquement. Les bases de ciment peuvent être effectuées de deux façons: ou bien mobiles ou bien adhérentes. Dans le premier cas, vous devez préparer une barrière à la vapeur (feuille de polythène) et, par conséquent, appliquez du polystyrène d'1 cm le long des murs périmétraux et le long de n'importe quel élément qui traverse le carrelage. Les joints de fractionnement sont conseillés tous les 5x5 m. Dans le cas de bases de ciment adhérentes, vous devez nettoyer la surface en ciment, puis appliquer une bouillie d'adhérence réalisée à base de ciment, d'eau et de latex appropriés. Quand celle-ci est encore fraîche, vous devez jeter dessus la nouvelle base adhérente en ciment. Les informations que contient ce paragraphe sont purement indicatives. Pour des renseignements plus approfondis, consultez la documentation spécialisée.

DE / Bei sehr großen Bodenflächen empfehlen wir, in besonderer Weise auf die Vorbereitung des Untergrunds zu achten. Dabei muss auf folgendes geachtet werden:

1. die thermische Dehnung;
2. die Verformung und Rissbildung aufgrund von Schwund und Austrocknung der Materialien;
3. die Setzung des Untergrunds.

Untergründe, die auf komprimierbaren Schichten wie Wärmedämmungen, Vermiculit oder Leichtton ausgeführt worden sind, müssen durch Stahlmatten verstärkt werden. Der Estrich kann auf zwei verschiedene Weisen verlegt werden: schwimmend oder aufliegend. Im ersten Fall muss eine Dampfsperre (Polyäthylenfolie) verlegt werden; dann 1 cm Styropor die Wände entlang sowie an allen Baukörpern, die den Boden unterbrechen. Zu allen 5x5 m werden Dehnungsfugen empfohlen. Bei aufliegendem Estrich die Zementoberfläche reinigen, dann eine Haftschrämme aus Zement, Wasser und Latex auftragen. Den neuen Estrich ausführen, wenn die Haftschrämme noch frisch ist. Die in diesem Abschnitt enthaltenen Informationen sind vollkommen unverbindlich. Für weitergehende Informationen verweisen wir auf die entsprechende Dokumentation. LEED-konformes Material, das heißt, es erfüllt die von der USGBC für die Materialien und Ressourcen festgelegten Anforderungen im Hinblick auf die Prozentzahl der recycelten Materialien, die Isolierung, die niedrige Schadstoffemission und die innovativen und designbezogenen Eigenschaften. Daraus folgt, dass die Verwendung von Alfalux-Produkten für Fußböden oder Andverkleidungen die Zuordnung einer Punktzahl erlaubt, die zur Vergabe der LEED-Zertifizierung beiträgt.

Posa in opera

Laying / Pose / Verlegung

IT / La posa di un pavimento può avvenire in due sistemi: il primo con una posa a cemento tradizionale, il secondo con l'uso di collanti. Per il primo caso consigliamo di adottare i seguenti accorgimenti:

- Non si deve immergere il materiale in acqua prima della posa;
- Spolvero in cemento nella quantità a rifiuto;
- Battere il pavimento con l'apposita macchina fino alla fuoriuscita della boiaccia.

Nel secondo caso consigliamo di:

- Procedere con l'uso di adesivi;
- Preparazione del piano di posa rendendolo sufficientemente planare senza fessurazioni e ben pulito;
- Preparazione dell'adesivo attenendosi alle istruzioni del produttore;
- Applicazione del collante e posa: applicare con la spatola dentata, coprendo la parte che a mano a mano si va posando. Le piastrelle andranno appoggiate, con una pressione leggera sulla superficie. Rimuovere di tanto in tanto per controllare che l'adesivo abbia bagnato sufficientemente il suo rovescio.

Le informazioni contenute in questo paragrafo sono puramente indicative. Per notizie più approfondite rimandiamo a documentazione specializzata.

EN / There are two systems for laying floor tiles: the first with traditional cement, and the second using glue. In the first case we recommend proceeding as follows:

- Do not submerge the material in water before laying,
- Sprinkle abundantly with cement,
- Pound the floor with an appropriate machine until the grout begins to extrude.

In the case of adhesives we recommend:

- Preparing the laying bed so that it is sufficiently flat, free of cracks and very clean,
- Prepare the adhesive according to the manufacturer's instructions,
- Glue application and laying: apply the glue with a toothed spatula, covering each section as laying proceeds. The tiles are set in position with a light surface pressure. Occasionally remove one to check that the adhesive has sufficiently covered the back of the tile.

The information contained in this paragraph is purely indicative. For more-in-depth information, we refer you to the special documentation.

FR / La pose d'un carrelage peut se faire de deux façons: la première est la pose traditionnelle sur du ciment, la seconde est celle effectuée à l'aide de colles. Dans le premier cas, nous vous conseillons de faire bien attention aux points suivants :

- Vous ne devez pas plonger les carreaux dans de l'eau avant de les poser ;
 - Saupoudrez la bouillie de ciment jusqu'à saturation;
 - Battez les carreaux à l'aide de la machine conçue à cet effet jusqu'à ce que la bouillie arrive à la surface des carreaux.
- Dans le deuxième cas, nous vous donnons les conseils suivants:
- Procédez dans l'utilisation des colles ;
 - Préparez la surface sur laquelle les carreaux seront posés: elle doit être suffisamment plate, sans fissures et parfaitement propre ;
 - Préparez la colle en suivant le mode d'emploi du producteur;
 - Appliquez la colle et posez les carreaux de la façon suivante: à l'aide d'une brosse dentée, appliquez la colle sur la partie de la surface que vous allez recouvrir au fur et à mesure de carreaux. Posez les carreaux et appliquez une légère pression sur leur surface. Enlevez un carreau de temps en temps pour vérifier que l'adhésif l'a suffisamment mouillé dessous.

Les informations que contient ce paragraphe sont purement indicatives. Pour des renseignements plus approfondis, consultez la documentation spécialisée.

DE / Die Verlegung eines Bodenbelags kann mit zwei Systemen erfolgen:

Das erste ist die herkömmliche Verlegung mit Zementmörtel, das zweite die Verlegung mit Kleber. Im ersten Fall empfehlen wir die Anwendung der folgenden Massnahmen:

- Das Material darf vor der Verlegung nicht in Wasser eingetaucht werden.
- Den Untergrund mit reichlich Zement abstreuen.
- Den Bodenbelag mit der entsprechenden Maschine abrütteln, bis die Schlämme austritt.

Im zweiten Fall empfehlen wir:

- Kleber zu verwenden;
- Vorbereitung des Verlegeuntergrunds, der ausreichend eben, frei von Rissen und sauber sein muss;
- Vorbereitung des Klebers unter Beachtung der Angaben des Herstellers;
- Auftragen des Klebers und Verlegung; mit der Zahnspachtel auftragen und nach und nach den Bereich abdecken, der verlegt wird. Die Fliesen werden mit einem leichten Druck auf die Oberfläche aufgesetzt. Ab und zu eine Fliese abheben, um zu kontrollieren, ob der Kleber die Rückseite in ausreichender Weise angefeuchtet hat. Die in diesem Abschnitt enthaltenen Informationen sind vollkommen unverbindlich.

Für weitergehende Informationen verweisen wir auf die entsprechende Dokumentation.

Stucature delle fughe

Joint grouting / Masticage / Stucken der fugen

IT / La stuccatura del pavimento posato dovrà avvenire il giorno seguente la posa "a colla". Le fughe dovranno essere perfettamente pulite in tutto il loro spessore; si deve successivamente inumidire con la spugna il bordo delle piastrelle. La fuga può essere eseguita con stucchi cementizi o epossidici preconfezionati. La stuccatura delle fughe viene effettuata con le apposite spatole di gomma, facendo penetrare con particolare cura lo stucco in profondità evitando i vuoti d'aria che possono crearsi. Si lascia asciugare il tutto e quando il sigillante incomincia a far presa, si procede ad asportare l'eccesso con una spugna umida. Per gli epossidici attenersi alle istruzioni del produttore. Nel caso di gres porcellanato levigato è consigliato per la stuccatura sporcare tutta la superficie della piastrella e non utilizzare una colorazione in contrasto con il colore della piastrella. Le informazioni contenute in questo paragrafo sono puramente indicative. Per notizie più approfondite rimandiamo a documentazione specializzata.

EN / The sealing of the laid floor joints should take place the day after laying with glue. The joints must be perfectly clean right across their width. The edges of the tiles should be dampened with a sponge. Joints can be filled with ready-made cement or epoxy filler. The joints are filled using a special rubber spatula, taking great care to ensure the full penetration of the filler and avoiding the formation of air gaps. Leave to dry, and when the filler begins to set, remove the excess with a damp sponge. With epoxy fillers, follow the manufacturer's instructions. When laying polished porcelain stoneware it is advisable to dirty the entire surface of the tile with the filler and not to use a colour that contrasts with the colour of the tiles. The information contained in this paragraph is purely indicative. For more-in-depth information, we refer you to the special documentation.

FR / Le jointoiment du carrelage posé doit se faire le lendemain de la pose "à la colle". Vous devez d'abord nettoyer parfaitement les joints sur toute leur épaisseur et ensuite humidifier le bord des carreaux à l'aide d'une éponge. Le jointoiment peut être effectué avec des stucs en ciment ou avec des stucs oxycarbonés qui se trouvent dans le commerce déjà préparés. Pour effectuer le jointoiment, vous devez utiliser des brosses spéciales en caoutchouc: faites pénétrer le stuc en profondeur en faisant attention à ce qu'il ne se crée pas de vides d'air. Laissez sécher le tout et, quand le scellant commence à prendre, éliminez le stuc excédant à l'aide d'une éponge humide. Pour les oxycarbonés, conformez-vous au mode d'emploi du producteur. Si le carrelage que vous posez est en grès cérame poli, nous vous conseillons d'enduire toute la surface du carreau quand vous effectuez le jointoiment et de pas utiliser une couleur en contraste avec celle des carreaux. Les informations que contient ce paragraphe sont purement indicatives. Pour des renseignements plus approfondis, consultez la documentation spécialisée.

DE / Das Verfugen des verlegten Bodenbelags muss gleich am ersten Tag der Verlegung erfolgen. Die Fugen müssen in der gesamten Breite vollkommen sauber sein und anschließend muss der Rand der Fliese mit einem Schwamm angefeuchtet werden. Die Fuge kann mit Zementstuck oder gebrauchsfertigem Epoxydstuck ausgeführt werden. Das Verfugen der Fugen erfolgt mit entsprechenden Gummispachteln, wobei besonders darauf zu achten ist, dass die Masse in die Tiefe eindringt und dass Hohlräume vermieden werden. Alles antrocknen lassen und die überflüssige Masse mit einem feuchten Schwamm entfernen, wenn sie abzubinden beginnt. Bei Epoxydmassen die Anweisungen des Herstellers beachten. Bei geschliffenem Feinsteinzeug wird empfohlen, die gesamte Oberfläche der Fliese zu verschmutzen und zum Verfugen eine Farbe zu verwenden, die nicht im Kontrast zur Fliesenfarbe steht. Die in diesem Abschnitt enthaltenen Informationen sind vollkommen unverbindlich. Für weitergehende Informationen verweisen wir auf die entsprechende Dokumentation.

Manutenzione e pulizia di pavimenti e rivestimenti

Maintenance and cleaning of floors and walls / Entretien et nettoyage des sols et revêtements / Instandhaltung und reinigung von fussböden und verkleidungen

IT / Un pavimento o rivestimento murale **Alfalux** sia nella versione naturale che satinata che lappata o lucida, è sinonimo di bellezza, durata e resistenza nel tempo. La sua manutenzione non richiede particolari cure se non l'attenersi alle seguenti norme di Pulizia.

Prima pulizia

Si esegue normalmente una sola volta prima dell'utilizzo del pavimento/rivestimento e deve essere obbligatoriamente eseguita dopo la posa in opera e prima dell'uso del pavimento/rivestimento. Ha lo scopo di eliminare ogni traccia di cemento o stucco conseguente alla chiusura dei giunti.

Fughe con stucco cementizio - Lavare il pavimento/ rivestimento con un detergente specifico a base acida per ceramica (per i rivestimenti usare un detergente specifico acido in gel).

Fughe con stucco epossidico - è necessario non lasciare residui di prodotti a fine lavoro asportando tutto il materiale, anche se disperso in acqua e asciugando la superficie del manufatto. È consigliabile effettuare un lavaggio con appositi detergenti **entro 24 ore** circa dalla stuccatura e, comunque a stucco indurito all' interno della fuga.

Ovviamente più tempo passa tra la stuccatura già indurita e l'inizio del lavaggio e **più difficoltosa sarà la pulizia**.

Per entrambi i tipi di stucco si procede come di seguito:

- 1. Spazzare il pavimento/rivestimento raccogliendo lo sporco grossolano.**
- 2. Inumidire con acqua la superficie affinché le fughe vengano impregnate e pertanto protette dall'azione corrosiva dell'acido del detergente; evitare che il detergente venga a contatto con componenti di acciaio, alluminio e marmo naturale adiacenti al pavimento/rivestimento.**
- 3. Attenersi alla concentrazione del prodotto detergente (rapporto di miscelazione con l'acqua) indicata dal produttore, applicandolo con una spazzola e stenderlo.**
- 4. Durante il tempo d'azione che deve essere stabilito in relazione allo stato del pavimento strofinare lo sporco più ostinato (ad es. residui di malta, stucco, etc...).**
- 5. Sciacquare il pavimento/rivestimento con acqua e raccogliere subito l'acqua sporca (manualmente o con un apparecchio lavasciuga).**

L'operazione di prima pulizia, se ritenuto necessario, può essere ripetuta. Se la prima pulizia viene eseguita dopo che il pavimento/rivestimento è stato usato, sarà bene, prima dell'applicazione del prodotto acido, togliere con appositi detersivi alcalini (**sgrassanti**) eventuali presenze di sostanze grasse o simili (vedi Pulizia ordinaria).

Pulizia ordinaria

Per la pulizia quotidiana è sufficiente lavare il pavimento/ rivestimento con acqua e aggiunta di normali prodotti detergenti adatti a pulire superfici ceramiche (per i rivestimenti utilizzare detergenti in gel)

La superficie dei prodotti **Alfalux** essendo praticamente inassorbente, **non richiede l'applicazione di cere e/o prodotti siliconici di protezione che, al contrario, non devono mai essere usati (possono creare un film superficiale modificando le caratteristiche naturali del grès porcellanato).** **Il pavimento deve essere considerato pulito quando riacquista il suo aspetto originario.**

Tuttavia in presenza di macchie persistenti e difficili da togliere con la pulizia ordinaria, intervenire con impiego di detergenti più concentrati lasciando agire lo stesso per un adeguato intervallo di tempo e, successivamente, strofinare con più intensità fino a ricondurre le piastrelle all'aspetto originario. Al riguardo è opportuno segnalare che il grès è resistente a qualsiasi sostanza chimica, **eccezion fatta per l'acido fluoridrico che attacca tutti i prodotti ceramici e che, quindi, non deve essere utilizzato.** Per la pulizia di pavimenti in aree pubbliche si consiglia di intervenire dopo la chiusura dei locali, affinché il pavimento, alla riapertura, sia asciutto: in alternativa isolare il pavimento pulito fino alla sua completa asciugatura.

Superficie lucida e lappata

Com'è noto tutte le superfici lucide subiscono con l'uso un processo di opacizzazione. Nel caso dei prodotti **Alfalux**, grazie alle peculiari caratteristiche tecniche, questo processo di opacizzazione è più lento rispetto a qualsiasi altro materiale naturale (marmo, granito, pietre...). Per conservare tuttavia il più a lungo possibile la lucentezza originale del pavimento è bene proteggere l'ingresso del locale pavimentato, specie se questo è in diretta comunicazione con ambienti esterni, con uno zerbino o altri strumenti idonei al fine di trattenere il più possibile polveri o altre sostanze abrasive al di fuori della pavimentazione.

Una leggera diminuzione della lucentezza, a seguito del primo lavaggio acido del pavimento, deve essere considerata normale, perché dovuta alla eliminazione dei residui degli abrasivi utilizzati nella lavorazione della superficie.

EN / A Alfalux floor or wall covering, in the natural, honed, semi-polished or polished version, is synonymous with beauty, durability and resistance over time.

Its maintenance does not require special treatments except for the compliance with the following cleaning rules.

Initial cleaning

This is normally carried out once before the wall/floor tiling is put into use; it must be performed after laying and before using the floor/wall. It aims to remove all traces of concrete or grout following the filling of the joints.

Joints with concrete grout - Wash the floor/wall with a specific acid-based detergent for ceramics (for wall tiles use a specific gel acid detergent).

Joints with epoxy grout - Since no residues must remain after the work, remove all material, even if dispersed in water, and dry the surface of the product. It is advisable to wash with special cleaning agents within 24 hours of grouting and anyway when the grout has hardened in the joint.

Obviously the more time that elapses between the already-hardened grouting and the beginning of the wash, the more the cleaning will be difficult.

For both types of grout proceed as follows:

- 1. Sweep the wall/floor to collect the coarse debris.**
- 2. Moisten the surface with water so that the joints are impregnated and protected from the action of the acid contained in the detergent; prevent the detergent from coming into contact with steel, aluminium and natural marble components next to the floor/wall.**
- 3. Respect the detergent concentration (mixing ratio with water) indicated by the manufacturer, spreading it with a brush.**
- 4. During the exposure time, which must be determined in relation to the state of the floor, scrub the most stubborn dirt (i.e. mortar and grout residues, etc.).**
- 5. Rinse the floor/wall with water and immediately collect the dirty water (manually or with a washer-dryer). The first cleaning operation, if deemed necessary, can be repeated.**

If the first cleaning is performed after the floor/wall has been used, it is a good idea, before applying the acid product, to remove with alkali detergents (degreasing agents) any greasy substances or similar (see Ordinary cleaning).

Ordinary cleaning

For daily cleaning it is sufficient to wash the floor/wall with water adding normal detergents suitable for cleaning ceramic surfaces (use gel detergents for walls).

The surfaces of Alfalux products, being practically non-absorbent, do not require the application of waxes and/or silicone products which, on the contrary, must never be used (they can create a surface film, changing the natural characteristics of porcelain tiles).

The floor must be considered clean when it regains its original appearance.

However if there are stains which are persistent and difficult to remove with normal cleaning, intervene by using more concentrated detergent, leaving it on for an adequate time interval and then scrub it more vigorously to bring the tiles back

to their original appearance. In this respect it should be noted that stoneware is resistant to any chemical substance with the exception of hydrofluoric acid that attacks all ceramic products and that must therefore never be used. In order to clean floors in public areas it is advisable to intervene after the closure of the premises, so that the floor is dry at reopening; alternatively close off the clean floor until it is completely dry.

Honed and semi-polished surface

As we know, all glossy surfaces undergo a process of dulling with use. In the case of Alfalux products, thanks to their special technical characteristics, this dulling process is slower than in any other natural material (marble, granite, stones, etc.). However, to preserve the original gloss of the floor for as long as possible it is a good idea to protect the entrance to the tiled room, especially if it communicates directly with external environments, with a mat or other appropriate means in order to keep dust or other abrasive substances off the floor as much as possible.

A slight decrease in gloss, following the first acid washing of the floor, must be regarded as normal, because it is due to the removal of abrasive residues used in the processing of the surface.

FR / Un revêtement de sol ou mural Alfalux en version naturelle, satinato, lappato ou lucido se caractérise par son esthétique, sa longévité et sa résistance dans le temps. Son entretien ne requiert pas de soins particuliers, si ce n'est le respect des règles suivantes en matière de nettoyage.

Nettoyage initial

Il est généralement effectué une seule fois avant l'utilisation du revêtement de sol/mural, et doit obligatoirement être réalisé après la pose et avant l'utilisation du revêtement de sol/mural. Son but est d'éliminer toute trace de ciment ou tout résidu suite au remplissage des joints.

Joints ciment - Nettoyer le revêtement de sol/mural avec un produit nettoyant à base acide pour céramique (pour les revêtements muraux, utiliser un gel nettoyant acide spécifique).

Joints époxy - Aucun résidu de produit ne doit être laissé à l'issue de la pose. Tout résidu, même couvert d'eau, doit être retiré et la surface du revêtement posé doit être séchée. Il est recommandé d'effectuer un nettoyage avec des produits spécifiques dans les 24 heures environ suivant le remplissage des joints, une fois que ceux-ci ont durci.

Bien sûr, plus le temps passe entre le durcissement des joints et le début du nettoyage, plus le nettoyage sera difficile.

Procéder comme indiqué ci-après pour les deux types de joints:

- 1. Balayer le revêtement de sol/mural en évacuant les saletés les plus grossières.**
- 2. Humidifier la surface avec de l'eau pour imprégner les joints et les protéger de l'action de l'acide du produit nettoyant ; éviter que le produit nettoyant n'entre en contact avec des composants en acier, en aluminium et en marbre naturel adjacents au revêtement de sol/mural.**
- 3. Respecter la quantité de produit nettoyant (rapport de mélange avec l'eau) indiquée par le fabricant et l'appliquer en l'étalant à l'aide d'une brosse.**
- 4. Pendant le temps d'action, à définir en fonction de l'état du sol, frotter les résidus (de mortier, joint, etc.) les plus tenaces.**
- 5. Rincer le revêtement de sol/mural à l'eau et recueillir immédiatement l'eau sale (manuellement ou avec une laveuse-sècheuse de sol).**

Si nécessaire, le nettoyage initial peut être répété.

Si le nettoyage initial est effectué alors que le revêtement de sol/mural a déjà été utilisé, il est préférable avant d'appliquer le produit acide d'éliminer les éventuelles substances grasses ou similaires présentes (voir Nettoyage ordinaire) avec des nettoyants alcalins (dégraissants) spécifiques.

Nettoyage ordinaire

Pour le nettoyage quotidien, il suffit de nettoyer le revêtement de sol/mural à l'eau, en y ajoutant des produits nettoyants normaux pour surface céramique (pour les revêtements muraux, utiliser des gels nettoyants).

La surface des produits Alfalux n'étant quasiment pas absorbante, il n'est pas nécessaire d'appliquer des cires et/ou produits silicones de protection ; au contraire, ceux-ci ne doivent jamais être utilisés (car ils peuvent créer une pellicule superficielle et modifier les caractéristiques naturelles du grès cérame).

Le sol est propre lorsqu'il a retrouvé son aspect d'origine.

En présence de taches persistantes et difficiles à éliminer par un nettoyage ordinaire, utiliser des produits nettoyants plus concentrés en les laissant agir pendant un temps adapté, puis frotter avec plus d'intensité jusqu'à ce que les carreaux aient retrouvé leur aspect d'origine. Signalons à ce sujet que le grès est résistant à toute substance chimique, à l'exception de l'acide fluorhydrique qui attaque tous les produits céramiques et ne doit donc pas être utilisé.

Pour le nettoyage des sols des lieux publics, il est conseillé d'intervenir après la fermeture pour que le sol soit sec au moment de la réouverture ; le cas échéant, isoler le sol nettoyé jusqu'à son séchage complet.

Surface lucida et lappata

Comme on le sait, toutes les surfaces brillantes s'opacifient avec le temps. Grâce aux caractéristiques techniques spécifiques des produits Alfalux, ce processus d'opacification est plus lent par rapport aux autres matériaux naturels (marbre, granit, pierre, etc.). Pour conserver le plus longtemps possible l'éclat du sol, l'entrée du lieu où il a été posé, en particulier s'il communique directement avec l'extérieur, doit être protégée avec un paillason ou d'autres accessoires permettant de retenir un maximum de poussières ou d'autres substances abrasives.

Une légère diminution de l'éclat du sol après le premier nettoyage acide est normale. Elle est due à l'élimination des résidus des abrasifs utilisés pour le traitement de surface.

DE / Ein Fußboden oder eine Wandverkleidung von Alfalux ist sowohl in der Matt als auch in der Satinato, Halbpoliert oder Lucido Version Synonym für unvergängliche Schönheit, Dauer und Resistenz.

Die Instandhaltung erfordert keine besondere Pflege, die über die folgenden Reinigungsvorschriften hinausgeht.

Erstreinigung

Sie wird normalerweise nur einmal vor dem Gebrauch des Fußbodens/der Verkleidung vorgenommen und muss auf jeden Fall nach der Verlegung und vor dem Gebrauch des Fußbodens/der Verkleidung erfolgen.

Sie dient zur Beseitigung aller durch das Schließen der Fugen entstandenen Zement- und Stuckspuren.

Fugen mit Zementstuck - Den Fußboden/die Verkleidung mit einem speziellen Reinigungsmittel für Keramik auf saurer Basis reinigen (für die Verkleidungen ein spezielles saures Reinigungsgel verwenden).

Fugen mit Epoxydstuck - Nach beendeter Arbeit dürfen keine Rückstände des Produkts zurückbleiben und das gesamte Material muss, auch mit Hilfe von Wasser und durch Trocknen der entsprechenden Fläche, entfernt werden. Es empfiehlt sich innerhalb von circa 24 Stunden nach der Spachtelung eine Reinigung mit den geeigneten Reinigungsmitteln vorzunehmen, jedoch auf jeden Fall erst wenn der Stuck im Innern der Fuge verhärtet ist.

Je mehr Zeit zwischen der schon verhärteten Spachtelung und dem Beginn der Reinigung vergeht umso schwieriger wird die Reinigung.

Bei beiden Stuckarten wird folgenderweise verfahren:

1. Den Fußboden/die Verkleidung säubern und den groben Schmutz entfernen.

2. Die Oberfläche mit Wasser befeuchten, damit die Fugen imprägniert und somit vor der Wirkung des Reinigungsmittels geschützt werden; es muss vermieden werden, dass das Reinigungsmittel mit Stahl-, Aluminiumkomponenten und natürlichem Marmor in der Nähe des Fußbodens/der Verkleidung in Berührung kommt.

3. Die vom Hersteller angegebene Konzentration der Reinigungsprodukts beachten (Mischungsverhältnis mit Wasser) und mit einer Bürste auftragen und verteilen.

4. In der Einwirkungszeit, die auf Grund des Zustand des Fußbodens festzulegen ist, den hartnäckigsten Schmutz aufwischen (z. B. Rückstände von Mörtel, Stuck etc...).

5. Den Fußboden/die Verkleidung mit Wasser nachspülen und das schmutzige Wasser sofort (bei Hand oder mit einem Bodenreiniger und -trockner) entfernen.

Der erste Reinigungsvorgang kann bei Erfordernis wiederholt werden.

Wenn die Erstreinigung nach Benützen des Fußbodens/der Verkleidung erfolgt, ist es sinnvoll vor dem Auftragen des sauren Produkts mit geeigneten alkalischen (entfettenden) Reinigungsmitteln eventuelle Spuren von Fett oder ähnlichem zu entfernen (siehe normale Reinigung).

Normale Reinigung

Für die tägliche Reinigung ist es ausreichend, wenn der Fußboden/die Verkleidung mit Wasser und einem Zusatz von

normalen Reinigungsmitteln für Keramikflächen gereinigt wird (für die Verkleidungen Reinigungsgel verwenden).

Die Oberfläche der Produkte von Alfalux ist nicht absorbierend, sie erfordert kein Auftragen von Wachs und/oder schützenden Silikonprodukten, die sogar niemals verwendet werden dürfen (sie können einen Oberflächenfilm erzeugen und so die natürlichen Charakteristiken des Feinsteinzeugs verändern). Der Fußboden gilt als sauber, wenn er wieder sein ursprüngliches Aussehen hat.

Allerdings ist bei hartnäckigen Flecken, die mit der normalen Reinigung schwer zu entfernen sind, der Gebrauch von stärker konzentrierten Reinigungsmitteln sinnvoll. Man lässt sie ausreichend lang einwirken und wischt anschließend kräftig darüber, bis die Fliesen wieder ihr ursprüngliches Aussehen erhalten. Diesbezüglich muss darauf hingewiesen werden, dass das Steinzeug resistent gegen alle chemischen Substanzen ist, mit Ausnahme von Fluorwasserstoffsäure, die alle Keramikprodukte angreift und deshalb nicht verwendet werden darf.

Für die Reinigung von Fußböden in öffentlichen Bereichen empfiehlt es sich nach Schließen des Lokals zu reinigen, damit er Fußboden bei der nächsten Öffnung trocken ist. Als Alternative kann der saubere Fußboden isoliert werden, bis er vollständig trocken ist.

Lucido und Halbpoliert Flächen

Es ist bekannt, dass bei Gebrauch alle blanken Flächen glanzlos werden. Im Vergleich zu anderen natürlichen Materialien (Marmor, Granit, Stein) wird bei den Produkten Alfalux dieser Prozess verzögert, dank der besonderen technischen Charakteristiken. Um den ursprünglichen Glanz des Fußbodens allerdings so lange wie möglich zu erhalten, besonders wenn er direkt mit Außenbereichen verbunden ist, sollte der Eingang zum Fußboden des Lokals mit einer Fußmatte oder anderen zweckmäßigen Vorrichtungen geschützt werden, um Staub und sonstiges scheuerndes Material nicht auf den Fußboden zu bringen.

Eine leichte Verminderung des Glanzes nach der ersten sauren Reinigung des Fußbodens ist normal, weil sie auf die Beseitigung der Rückstände der bei der Bearbeitung der Oberfläche verwendeten Schleifmittel zurückführbar ist.

Guida alla posa

Large format slabs: Storage, Handling, Installation / Guide de pose / Verlegungsanleitung



Introduzione / Introduction

Per grande formato si definiscono quelle lastre, quadrate o rettangolari, dove entrambi o solamente uno dei due lati risulta essere maggiore di 60 cm.

Large format refers to square or rectangular slabs where one or both of the dimensions is greater than 60 cm. (UNI 11493-1:2016).

- 1. La scelta dell'adesivo** / Adhesive Selection / Choix de la colle / Wahl des Klebers
- 2. La tecnica di posa** / Installation Technique / Technique de pose / Verlegungstechnik
- 3. Il taglio e la foratura** / Cutting and Drilling / Découpe et perçage / Schneiden und Bohren
- 4. Lo stoccaggio a magazzino e l'imballo** / Storage / Stockage / Lagerung
- 5. La movimentazione** / Handling / Manutention / Handhabung

IT / 1. SCELTA DELL'ADESIVO

La corretta scelta e prescrizione del collante è di fondamentale importanza nella posa di grandi formati. Più specificatamente, la migliore tipologia di adesivo deve essere scelta in funzione di:

- Destinazione d'uso
- Condizioni di esercizio
- Tipologia di supporto
- Dimensione della lastra ceramica

Di seguito alcuni accorgimenti generali che possono aiutare per selezionare il corretto adesivo:

- in generale, per la posa dei grandi formati su supporti "tradizionali" (ad esempio massetti cementizi è consigliabile l'utilizzo di un adesivo di classe C2 caratterizzato da alta deformabilità (classe S2).
 - per la posa in ambienti con climi freddi o umidi, o durante il periodo invernale quando la temperatura può abbassarsi sotto i 0°C, è consigliabile l'utilizzo di un adesivo a presa rapida (classe F) per facilitare la stagionatura dello strato di allettamento;
 - per la posa in ambienti con climi caldi e secchi o con frequente ed abbondante ventilazione, o durante il periodo estivo quando la temperatura può raggiungere valori elevati, è consigliabile l'utilizzo di un adesivo a tempo aperto prolungato (classe E) per evitare che il collante crei la pellicola superficiale, inibendo del tutto il potere adesivo dello stesso. Importante: qualora si crei questa pellicola, è opportuno sottolineare che il collante perde ogni potere d'adesione e non può in nessun caso essere utilizzato;
 - in virtù del tempo necessario per poter stendere il collante, specialmente per i formati più grandi quali il 120x120 e cm, è normalmente consigliabile prescrivere un adesivo a tempo prolungato sia sul retro della lastra che sul supporto di posa.
 - per la posa su supporti scarsamente porosi (ad esempio, pavimentazioni in grès preesistenti) o con umidità elevata (ma sempre al di sotto dei requisiti dettati dalla normativa UNI 11493-1:2016) è consigliabile l'utilizzo di un adesivo a presa rapida (Classe F) per facilitare la stagionatura dello strato di allettamento.
 - nel caso di posa su supporti in gesso, massetti in anidrite o solfato di calcio, è sempre consigliabile prevedere la stesura di un opportuno primer precedentemente le operazioni di posa.
 - nel caso di posa a parete in esterno, ove le lastre in ceramica sono sottoposte a sensibili movimenti di contrazione-dilatazione per effetto dei gradienti termici diurni e stagionali, si rende necessario l'utilizzo di un adesivo altamente deformabile, capace di assecondare i

naturali movimenti del rivestimento, ammortizzando così le tensioni generate sul sottostante supporto e producendo un rilassamento dello sforzo che evita il distacco del rivestimento ceramico dal supporto.

A titolo indicativo, si riporta di seguito una tabella ove sono indicati i requisiti minimi consigliati per la posa di lastre di grande formato, a seconda dell'ambiente e del tipo di supporto.

EN / 1. ADHESIVE SELECTION

Choose adhesive on the basis of:

- End use
- Installation conditions
- Support type
- Dimensions of ceramic slab

Indications for adhesive selection

- Traditional supports (cementitious screed) → highly flexible Class C2 adhesives (Class S2)
 - Installation in cold, humid climates, during winter → quick setting adhesive (Class F)
 - Installation in hot, dry climates with good ventilation, or during summer → adhesive with extended open time (Class E).
 - Installation must be fully complete before the adhesive forms a skin (causing it to lose all adhesive power).
 - Installation on low-porosity supports (pre-existing ceramic tile) or under high humidity → fast-setting adhesives (Class F), for more rapid curing;
 - Installation on plaster, anhydrite or calcium sulphate screeds → primer prior to installation
 - Installation on external walls → Class S2 highly deformable adhesives, for absorption of cladding movement.

Choisir la colle en fonction des éléments suivants.

FR / 1. CHOIX DE LA COLLE

- Utilisation prévue
- Conditions de pose
- Type de support
- Dimensions de la dalle céramique

Indications pour choisir la bonne colle:

- Supports traditionnels (chapes de ciment) → colle de classe C2 de haute déformabilité (classe S2)
- Pose dans des environnements froids ou humides, en hiver → colle à prise rapide (classe F)
- Pose dans des environnements chauds et secs, bien ventilés, ou en été → colle avec temps ouvert allongé (classe E). La pose doit être terminée avant que la colle ne forme un film de surface (ce qui inhiberait complètement son pouvoir adhésif).
- Pose sur des supports peu poreux (anciens sols céramiques) ou très humides → colle à prise rapide (classe F) pour faciliter le séchage.
- Pose sur enduit de plâtre, chapes anhydrites ou à base de sulfate de calcium → appliquer un primaire avant la pose.
- Pose murale extérieure → colle de haute déformabilité (classe S2), capable d'absorber les mouvements du revêtement.

DE / 1. WAHL DES KLEBERS

Der Kleber ist in Funktion folgender Faktoren zu wählen:

- Einsatzbereich
- erlegungsbedingungen
- Art des Untergrundes
- Abmessungen der Keramikplatte

Hinweise zur Wahl des richtigen Klebers:

- Traditionelle Untergründe (Zementestrich) → Hochverformbarer Kleber der Klasse C2 (Klasse S2).
- Verlegung in Umgebungen mit kalten oder feuchten Klimaverhältnissen → Schnellhaftender Kleber (Klasse F)
- Verlegung in Umgebungen mit warmen und trockenen Klimaverhältnissen und guter Ventilation, oder in der Sommerzeit → Kleber mit langer Offenzeit (Klasse E). Die Verlegung ist zu vollenden, bevor der Kleber an der Oberfläche einen Film bildet (und damit sein Haftvermögen vollkommen verliert).
- Verlegung auf kaum porösen Untergründen (alte Keramikfliesen), oder auf solchen mit hoher Feuchtigkeit → Schnellhaftender Kleber (Klasse F), um die Reifung zu erleichtern.
- Verlegung auf Putz, Anhydrit- oder Calciumsulfatestrichen → Vor der Verlegung einen Primer auftragen.
- Wandverlegung in Außenbereichen → Hochverformbarer Kleber (Klasse S2), der die Bewegungen der Verkleidung absorbieren kann.

TIPOLOGIA DI SUPPORTO Support type Type de support Art des Untergrundes	POSA IN INTERNO Interior installation Pose en intérieur Verlegung in Innenbereichen		POSA IN ESTERNO Exterior installation Pose en extérieur Verlegung in Außenbereichen	
	PAVIMENTO floor / sol Boden	PARETE wall / mur Wand	PAVIMENTO floor / sol Boden	PARETE wall / mur Wand
Massetti cementizi senza sistema di climatizzazione radiante Cementitious screed without radiant heating/cooling Chapes ciment sans chauffage au sol Zementestriche ohne Heiz-/Klimatisierungssystem	C2 E S1		C2 E S2	
Massetti cementizi con sistema di climatizzazione radiante Cementitious screed with radiant heating/cooling Chapes ciment avec chauffage au sol Zementestriche mit Heiz-/Klimatisierungssystem	C2 E S2			
Massetti in anidrite o solfato di calcio, con o senza sistema di climatizzazione radiante Anhydrite or calcium sulphate screed, with or without radiant heating/cooling Chapes anhydrites ou à base de sulfate de calcium, avec ou sans chauffage au sol Anhydrit- oder Calciumsulfatestriche, mit oder ohne Heiz-/Klimatisierungssystem	C2 E S2		C2 E S2	
Pavimentazioni preesistenti in ceramica o pietra Pre-existing flooring in ceramic tile or stone Anciens sols en céramique ou pierre Altfußböden aus Keramik oder Naturstein	C2 F E S2		C2 F E S2	
Parete in calcestruzzo / Cement wall / Mur béton / Betonwand		C2 T E S2		C2 T E S2
Intonaco cementizio / Cementitious plaster / Enduit ciment / Zementputz		C2 T E S2		C2 T E S2
Pannelli o superfici in metallo, pannelli e compositi di legno, gomma, resilienti Metal panels or surfaces, wood panels and composites, rubber, resilient materials Panneaux ou surfaces en métal, panneaux et composites de bois, caoutchouc, résilients Tafeln oder Oberflächen aus Metall, Tafeln und Verbundmaterialien aus Holz, Gummi, Weichmaterialien	R2 T ¹	R2 T ¹	R2 T ¹	R2 T ¹

1 indicazione di massima. Vista la varietà e le peculiarità di tali supporti, è sempre necessario consultare, prima della scelta, il produttore dell'adesivo.

IT / 2. PRESCRIZIONI GENERALI RIGUARDANTI LA TECNICA DI POSA DEI GRANDI FORMATI

Fatta salva l'idoneità del supporto su cui le lastre saranno installate, una corretta tecnica di posa rappresenta un caposaldo fondamentale da seguire fedelmente al fine di ottenere le migliori performances tecniche da una pavimentazione/rivestimento.

Sia a pavimento che a rivestimento, il requisito fondamentale per una posa a regola d'arte è il raggiungimento del letto pieno d'adesione, vale a dire la condizione in cui lo strato di adesivo tra il retro della lastra ed il supporto di posa è il più possibile continuo, compatto e privo di vuoti. (1)

A pavimento, questa condizione permette alla piastrellatura ceramica di resistere alle sollecitazioni meccaniche per le quali è stata progettata. A rivestimento, la condizione di letto pieno assicura una sicura adesione tra ceramica e muratura che eviti distacchi, ribaltamenti, ecc.

La fuga a giunto unito è in generale da sconsigliarsi per ragioni tecniche, prediligendo in ogni caso la posa a giunto aperto (2), particolarmente indicata nel caso di lastre di grande formato o esposte a livelli di sollecitazione meccanica e igrotermica elevati. Questo tipo di posa permette di ridurre sensibilmente il modulo di elasticità della piastrellatura, e quindi la sua rigidità, impedendo in misura relativamente efficace i rischi di sollevamento, distacco o fessurazione delle lastre stesse.

L'interposizione di opportune giunture tecniche (giunti di deformazioni, perimetrali, frazionamento) nelle quali le fughe sono iscritte permette alla pavimentazione di sopportare meglio le sollecitazioni meccaniche e termo-igrometriche a cui la piastrellatura dovrà resistere.

I giunti perimetrali sono posti lungo il confine dell'ambiente da rivestire, ed in corrispondenza di tutti gli elementi della costruzione (pilastri, colonne, tubi).

I giunti di frazionamento a pavimento devono suddividere le piastrellature di grandi dimensioni in campiture di forma approssimativamente quadrata. Interessano tutto lo spessore della piastrellatura (lastra ed adesivo) e parte del supporto, per circa 1/3 del suo spessore.

È consigliabile mantenere un'area massima delle campiture dei giunti di frazionamento pari a 24 / 25 m² in ambienti interni e 9 / 10 m² in ambienti esterni. Il rapporto tra il maggiore ed il minore dei lati della campitura non deve essere maggiore di 1,5. I giunti di dilatazione interessano esclusivamente lo spessore della piastrellatura (ceramica + adesivo) e devono integrare ed includere la campitura dei giunti di frazionamento per suddividere ulteriormente, laddove ve ne sia bisogno in forza di sollecitazioni meccaniche o termo-igrometriche severe, la piastrellatura in riquadri dilatanti più fitti.

Per dimensionamento della larghezza dei giunti (i cui valori oscillano normalmente tra 5 e 12 mm) si tiene conto delle sollecitazioni meccaniche e termo-igrometriche d'esercizio della piastrellatura e delle capacità elastiche del materiale che costituisce il giunto (in ogni caso, nella realizzazione di tali giunti, è opportuno seguire le indicazioni di fabbricazione fornite dal produttore). (3)

EN / 2. INSTALLATION TECHNIQUE

Full-bed adhesion: the adhesive layer between slab rear and support is as continuous, compact and free of voids as possible. (1)

This is achieved by double spreading.

Open-joint installation: always recommended, and especially in locations with high levels of mechanical or hygrothermic stresses (2). Reduces the elastic modulus of the tiling, lessening risks of raising, detachment and cracking in the finished tiling. Technical joints: the tile edges are inserted in the joints → gaining better support against mechanical and hygrothermic stresses.

Perimeter joints, around the edges of the area to be tiled and against intervening structural elements
Subdivision joints, inserted through the thickness of the slab + adhesive + 1/3 of screed
Expansion joints, inserted only through slab + adhesive

Sizing subdivision joints – area:

- 24 - 25 m² for interior installations
- 9 - 10 m² for exterior installations
- length/width ratio: < 1.5.

Sizing subdivision joints – joint width: on the basis of mechanical and hygrothermic stresses of the tiling installation and elastic capacities of the joint materials. (3)

FR / 2. TECHNIQUE DE POSE

Collage en plein: la couche de colle entre le dos de la dalle et le support est continue, compacte et exempte de vides. (3)
Cela s'obtient grâce au double encollage.

Pose à joint ouvert: toujours recommandée et particulièrement indiquée en cas de pose dans des environnements soumis à des contraintes mécaniques et hygrothermiques élevées. (4)
Ce type de pose réduit le module d'élasticité du carrelage et, par conséquent, les risques de soulèvement, de décollement ou de fissuration des dalles posées.

Joints techniques: les bords du carreau sont insérés dans les joints → meilleure résistance aux contraintes mécaniques et thermo-hygrométriques.

Joints périphériques: placés le long du périmètre de l'espace à revêtir et au niveau de tous les éléments verticaux du bâtiment.

Joints de fractionnement: insérés dans l'épaisseur de la dalle + colle et sur environ 1/3 de l'épaisseur de la chape.

Joints de dilatation: insérés exclusivement dans l'épaisseur de la dalle + colle.

Dimensionnement des joints de fractionnement - surface:

- 24-25 m² pour un usage intérieur
- 9-10 m² pour un usage extérieur
- rapport longueur/largeur < 1,5.

Dimensionnement des joints de fractionnement - largeur des joints: suivant les contraintes mécaniques et thermo-hygrométriques du carrelage et de la capacité élastique du matériau constituant le joint (5, 6, 7)

DE / 2. VERLEGUNGSTECHNIK

Verkleben im Vollbett: Die Kleberschicht zwischen Plattenrückseite und Untergrund ist kontinuierlich, kompakt und ohne leere Stellen. (3)

Dies wird durch einen doppelten Kleberaufstrich erzielt.

Verlegung mit offener Fuge: Wird immer empfohlen und ist besonders für Bereiche mit hohen mechanischen und hygrothermischen Beanspruchungen geeignet. (4)

Diese Art von Verlegung reduziert das Elastizitätsmodul der Verfliesung und demzufolge auch das Risiko eines Abhebens/ Ablösens oder von Rissbildungen an den verlegten Platten.

Technische Verbindungen: Die Kanten der Fliese werden in

die Verbindungen eingesetzt → Dadurch wird eine bessere Widerstandsfähigkeit gegenüber mechanischen und hygrothermischen Beanspruchungen erzielt.

Randfugen: Sie werden am Umfang des zu verkleidenden Bereichs entlang und an allen Bauelementen eingesetzt.

Fraktionierungsfugen: Sie werden in der Plattendicke + Kleber und an ca. 1/3 der Estrichdicke eingeplant.

Dehnungsfugen: Sie werden ausschließlich in der Plattendicke + Kleber eingeplant.

Bemessung der Fraktionierungsfugen - Oberfläche:

- 24-25 m² für Innenbereiche
- 9-10 m² für Außenbereiche
- Verhältnis Länge/Breite < 1,5.

Bemessung der Fraktionierungsfugen - Fugenbreite: Auf Grundlage der mechanischen und hygrothermischen Beanspruchungen der Verfliesung und des Elastizitätsvermögens des Fugenmaterials (5, 6, 7)

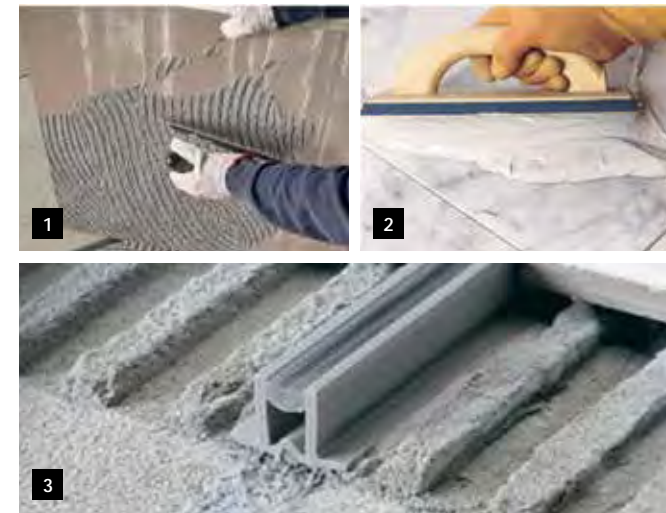

IT / 2.1. POSA DELLE LASTRE A PAVIMENTO

Per effettuare una posa a pavimento a regola d'arte, consigliamo questi passaggi:

- Stendere il collante sul supporto di posa, avendo cura di aver precedentemente verificato che possiede tutti i requisiti di qualità necessari per la posa di lastre in grande formato. L'adesivo deve essere steso con una spatola dentata (possibilmente a rebbi inclinati) da 10 mm lungo una sola direzione, preferibilmente quella parallela al lato corto in caso di piastrella rettangolare. Questo accorgimento facilita l'espulsione dell'aria durante la fase di vibrazione e contribuisce ad ottenere il letto pieno d'adesione.
- Stendere il collante sul retro della lastra, con una spatola dentata da 3 mm, nella medesima direzione utilizzata per spalmare il collante sul supporto di posa.
- Movimentare la lastra provvista di strato di adesivo e posizionarla sul supporto di posa ove è stato precedentemente steso il collante.
- Nel caso di posa dei formati 120x120 cm è consigliabile

l'utilizzo dei predetti carrelli che consentono un trasporto in tutta sicurezza ed aiutano gli operatori a posizionare la lastra in orizzontale. (4) In caso di altri formati, la movimentazione ed il posizionamento delle lastre può avvenire tramite mono o bi-ventose e senza l'ausilio di telai preposti. (5)

- Una volta posizionata, muovere delicatamente la lastra, facendo compiere piccoli spostamenti in tutte e quattro le direzioni del piano.
- Nell'effettuare il posizionamento delle lastre adiacenti, rispettare le distanze per le fughe imposte dai distanziatori.
- A tal proposito, nel caso di lastre di grande formato si consigliano opportuni livellatori che facilitano il processo di allineamento delle fughe ed al contempo aiutano nell'evitare dislivelli tra una lastra e l'altra.
- Infine, segnaliamo che vi sono opportuni attrezzi, detti "accosta-lastre" che permettono di effettuare movimenti di precisione per ottenere un corretto posizionamento. (6)
- Effettuare una opportuna vibrazione utilizzando frattazzi antirimbazzo manuali o vibratori elettrici, partendo dal centro della lastra verso i lati della stessa, su tutta la superficie in maniera continua ed uniforme. (7) Questa operazione è necessaria in quanto consente di eliminare i vuoti all'interno dello strato di collante ed aiuta il raggiungimento della condizione di letto pieno d'adesione. Per questa operazione, si consiglia di non utilizzare martelli ancorché gommati.
- Attendere la stagionatura del collante, secondo le indicazioni fornite dal produttore, prima di camminare sopra la superficie della pavimentazione. Per tutto il tempo della stagionatura, la pavimentazione deve risultare protetta da carichi accidentali. Le fughe non stuccate, devono essere protette da polvere e residui.

EN / 2.1. FLOOR INSTALLATION STEPS

Spread the adhesive on the installation surface using a 10mm-toothed trowel, working in one direction only (parallel to short side for rectangular slabs).

Spread the adhesive on the rear of the slab using a 3mm-toothed trowel, working in matching direction.

Carefully move the slab into position, placing adhesive against the support surface.

Move the slab delicately, making small movements in all four surface directions.

Use slab-handling tools for precise movement into correct position. (4, 5, 6)

Vibrate using a manual anti-bouncing tile beater or electric tile vibrator, from slab centre to sides, continuously and uniformly over the entire surface. (7)

Wait for adhesive to set according to the manufacturer's instructions before walking on tiled surfaces. Avoid accidental loading of the surface. Protect joints prior to grouting: prevent accumulation of dust and dirt in open joints.

FR / 2.1. POSE DES DALLES AU SOL

Étaler la colle sur le support à l'aide d'une truelle crantée de 10 mm, en travaillant dans un seul sens (parallèlement au côté court en cas de dalles rectangulaires).

Étaler la colle sur le dos de la plaque avec une truelle crantée de 3 mm, en travaillant dans le même sens.

Déplacer avec précaution la dalle et la positionner de manière à ce que la colle soit en contact avec la surface du support. Bouger doucement la dalle en effectuant de petits mouvements dans les quatre sens de la surface.

Pour le déplacement des dalles, utiliser des outils appropriés qui permettent d'effectuer des mouvements de précision en vue d'obtenir un positionnement correct. (4, 5, 6)

À l'aide de taloches anti-rebond ou de vibreurs électriques pour carrelage, frapper sur l'ensemble de la surface de la dalle. Procéder du centre vers les côtés, de manière continue et uniforme. (7)

Attendre que la colle soit sèche, selon les prescriptions du fabricant, avant de piétiner le sol. Protéger la surface contre les charges accidentelles. Protection des joints avant le jointoiment: éviter les dépôts de poussière et de résidus dans les joints ouverts.

DE / 2.1. BODENVERLEGUNG DER PLATTEN

Den Kleber mit einem 10 mm Zahnpachtel in eine einzige Richtung auf den Verlegungsuntergrund auftragen (parallel zur kurzen Seite, im Falle von rechteckigen Platten).

Den Kleber mit einem 3 mm Zahnpachtel in die gleiche Richtung auf die Plattenrückseite auftragen.

Die Platte aufmerksam verschieben und so positionieren, dass der Kleber die Oberfläche des Untergrundes berührt.

Die Platte mit kleinen Verschiebungen vorsichtig in alle vier Richtungen der Ebene bewegen.

Zur Handhabung der Platten sind geeignete Werkzeuge zu verwenden, die präzise Bewegungen ermöglichen, um eine korrekte Positionierung zu erzielen. (4, 5, 6)

In kontinuierlicher und gleichmäßiger Weise auf der gesamten Oberfläche mit einem Hand-Schlagbrett oder einem elektrischen Fliesen vibrator einen Vibrationsvorgang durchführen, von der Plattenmitte ausgehend bis zu den Plattenrändern. (7)

Vor dem Begehen der Oberfläche des Bodenbelages ist die vom Hersteller angegebene Trockenzeit des Klebstoffes abzuwarten. Die Oberfläche vor Nutzlasten schützen.

Schutz der Fugen vor dem Verfugen: Anhäufungen von Staub und Rückständen in den noch offenen Fugen vermeiden.



IT / 2.2. POSA DELLE LASTRE A RIVESTIMENTO

Per effettuare una posa a rivestimento a regola d'arte, seguire i passaggi già menzionati al capitolo precedente

- Stendere il collante sul supporto di posa, avendo cura di aver precedentemente verificato che possieda tutti i requisiti di qualità necessari per la posa di lastre in grande formato. L'adesivo deve essere steso con una spatola dentata (possibilmente a rebbi inclinati) da 10 mm lungo una sola direzione, preferibilmente quella parallela al lato corto della lastra (onde facilitare l'espulsione dell'aria durante la fase di vibrazione ed assicurare il letto pieno d'adesione). Se il rivestimento prevede sistemi di aggancio di sicurezza "a vista", tipo Cp-Kerclip, prima della stesura del collante occorre ancorare i ganci al supporto con opportuni fissaggi di tipo meccanico (fesselli, sparachiodi, etc.) la cui estremità di testa possa essere "annegata" nello strato di adesivo steso (8)
- Stendere il collante sul retro della lastra, con una spatola dentata da 3 mm, nella medesima direzione utilizzata per spalmare il collante sul supporto di posa. Se il rivestimento prevede sistemi di aggancio di sicurezza "a scomparsa", tipo Cp-Kerfix, prima della stesura del collante è necessario eseguire l'incisione sul retro della lastra ove sarà alloggiato l'ancoraggio di sicurezza (nel caso in cui tale incisione non sia stata precedentemente effettuata in fabbrica). (9)
- Nel caso di incisione in cantiere, la distanza reciproca tra le incisioni dovrà essere non inferiore a 40 cm l'una dall'altra e dovrà essere effettuata con opportuni utensili che sono stati appositamente studiati. Dopo l'incisione, e comunque sempre prima della stesura dell'adesivo, occorre incastrare il gancio di sicurezza Cp-Kerfix all'interno della fresatura.
- Movimentare la lastra provvista di strato di adesivo e posizionarla sul supporto di posa ove è stato precedentemente steso il collante.

Nel caso di posa dei formati 90x270, 120x120 cm è consigliabile l'utilizzo dei predetti carrelli che consentono un trasporto in tutta sicurezza ed aiutano gli operatori a posizionare la lastra in orizzontale. In caso di altri formati, la movimentazione ed il posizionamento delle lastre può avvenire tramite mono o bi-ventose e senza l'ausilio di telai preposti.

- Una volta posizionata, muovere delicatamente la lastra, per mezzo del telaio a ventosa, facendo compiere piccoli spostamenti in tutte e quattro le direzioni.
- Nell'effettuare il posizionamento delle lastre adiacenti, rispettare le distanze per le fughe. L'utilizzo dei sistemi livellatori è possibile e consigliabile anche nel caso di posa a rivestimento verticale.
- Effettuare una opportuna vibrazione utilizzando frattazzi antirimbazzo "manuali" o vibratori elettrici, partendo dal centro della lastra verso i lati della stessa, su tutta la superficie in maniera continua ed uniforme. Questa operazione è necessaria in quanto consente di eliminare ogni tipo di vuoto all'interno del letto pieno d'adesione.
- Correggere eventuali difetti di planarità avvalendosi dei sistemi di livellamento in corrispondenza dei distanziali delle fughe.
- Ancorare i ganci del sistema Cp-Kerfix al supporto di posa con opportuni fissaggi meccanici (fesselli, sparachiodi, etc.) la cui estremità di testa possa essere "annegata" nello strato di adesivo steso.
- Attendere la stagionatura del collante, secondo le indicazioni fornite dal produttore, prima di effettuare

qualsiasi operazione sul rivestimento (fori, incisioni, etc.) o applicare carichi alla piastrellatura.

EN / 2.2. TIPS FOR WALL INSTALLATION

If installing wall cladding using (Cp-Kerclip) visible safety systems, anchor the clips to the support prior to spreading the adhesive (using anchors, nailgun, etc.) (8)

- If installing wall cladding using (Cp-Kerfix) invisible safety systems, cut the back of the slab prior to spreading the adhesive. If the slab cuts are carried out at the worksite, the distance between cuts must be > 40 cm.
- Carefully move the slab into position, placing the adhesive layer against the support surface. Anchor the Cp-Kerfix clips to the support surface. (9)
- Wait for adhesive to set according to the manufacturer's instructions before carrying out any cladding operations (holes, cuts, etc.), and before applying any loads to the tiling.

FR / 2.2. CONSEILS DE POSE MURALE

Si le revêtement mural prévoit des systèmes de fixation de sécurité « apparents », tels que le Cp-Kerclip, avant d'appliquer la colle, les crochets doivent être ancrés au support (à l'aide de chevilles, de clous, etc.). (8)

Si le revêtement mural prévoit des systèmes de fixation de sécurité « invisibles », tels que Cp-Kerfix, avant d'appliquer la colle, il est nécessaire de pratiquer l'incision au dos de la dalle. Pour les incisions réalisées sur place, la distance entre les incisions doit être > à 40 cm.

Manipuler et positionner la dalle avec précaution, en appliquant la couche de colle sur la surface du support. Fixer les crochets Cp-Kerfix sur la surface du support (9). Attendre que la colle soit sèche, suivant les prescriptions du fabricant, avant d'effectuer tout type d'opération sur le revêtement (trous, incisions, etc.) ou d'appliquer des charges sur le revêtement mural.

DE / 2.2. CONSEILS DE POSE MURALE

Falls die Wandverkleidung „sichtbare“ Sicherheitshakensysteme wie Cp-Kerclip vorsieht, sind vor dem Ausbreiten des Klebstoffes die Sicherheitshaken am Untergrund zu verankern (mit Dübeln, Nagelpistole, usw.). (8)

Falls die Wandverkleidung „unsichtbare“ Sicherheitshakensysteme wie Cp-Kerfix vorsieht, ist vor dem Ausbreiten des Klebstoffes an der Plattenrückseite der Einschnitt zu fertigen. Falls die Einschnitte auf der Baustelle gefertigt werden, darf der Abstand zwischen den Einschnitten nicht kleiner als 40 cm sein.

Die Platte vorsichtig bewegen und positionieren und die Kleberschicht an der Oberfläche des Untergrundes ansetzen. Die Haken Cp-Kerfix an der Oberfläche des Untergrundes befestigen (9). Bevor an der Verkleidung irgendwelche Vorgänge (Bohrungen, Einschnitte, usw.) ausgeführt oder Lasten auf der Verfliesung aufgebracht werden, ist die vom Hersteller angegebene Trockenzeit des Klebstoffes abzuwarten.



IT / 2.3. TAGLIO DELLE LASTRE

Per il taglio di lastre di grande formato occorre munirsi di una opportuna attrezzatura che permetta di effettuare tali operazioni in tutta sicurezza, sia per l'incolumità dell'operatore sia per preservare l'integrità della lastra stessa.

L'utilizzo di taglierine professionali ad acqua è da preferirsi per ottenere una migliore qualità del taglio (10,11)

Nel caso di taglio a secco, a seconda della tipologia di taglio e del formato della lastra, possono essere impiegati diverse varietà di utensili:

- Segnaliamo che in commercio esistono taglierine di dimensioni idonee per tagliare lastre di formato fino ad 60x120 cm (12)
- Lastre di dimensioni maggiori (ad esempio 90x270 e 120x120 cm) devono essere posizionate su di un piano rigido e stabile, che possa assorbire eventuali vibrazioni indotte dagli utensili di taglio, il quale può essere effettuato mediante idonee guide già equipaggiate di rotelline diamantate. Le guide devono essere ben ancorate alla lastra. (13)
- Qualsiasi sia l'utensile prescelto per effettuare un'operazione di questo genere, al fine di ottenere una linea di taglio ben definita e senza sbavature, si consiglia di controllare preventivamente lo stato di usura della rotellina di incisione e sostituirla, nel caso di usura evidente, con una nuova al widia/titanio o lega di carbonio. L'incisione deve essere progressiva ed uniforme, senza esercitare una eccessiva pressione in alcuni punti, mantenendo una velocità ed una forza costante lungo tutta la linea di incisione. La fase troncatrice, nel caso di tagli su lastre adagiate su di un piano di lavoro, deve essere effettuata mediante opportune pinze che agiscono, in contemporanea, sulle estremità delle linee di taglio ed una in mezzera, in modo da effettuare una pressione di troncatrice quanto più continua lungo tutta l'incisione. (14,15)
- Per effettuare tagli a scasso o riseghe, si può usare una comune smerigliatrice angolare munita di disco diamantato idoneo allo spessore della lastra. Per i formati più grandi, segnaliamo che alcune guide di taglio sono già predisposte per alloggiare la smerigliatrice angolare su di esse, in modo da guidare l'operatore durante la fase di incisione/taglio in maniera precisa e lineare. (16)
- In tutti i casi, si consiglia di dosare la velocità di avanzamento del disco diamantato proporzionalmente alla durezza del materiale: imprimere una velocità eccessiva potrebbe causare il danneggiamento della macchina, la deformazione del disco diamantato e la rottura della piastrella.

EN / 2.3. CUTTING AND DRILLING

Water cutting, using professional equipment for higher quality cuts. (10,11)

Dry cutting - select tools depending on the type of cut and slab format:

- Linear cutters for formats up to 60x120 cm. (12)
- 90x270, 120x120 cm formats → cut using a diamond blade with guide on a stable, rigid worktable, capable of absorbing vibrations from cutting tools. (13)
- Position the slabs on a solid, stable and rigid surface, capable of absorbing vibrations from cutting tools.
- Anchor the cutting guide to the slab. Most guides come with diamond cutters. Cut with uniform pressure, maintaining constant movement and force along the entire line of the cut. (14,15)
- Break using purpose-made pliers, acting simultaneously at the two extremities and at the centre of the cut line.
- Angle grinder with diamond disc for straight-line cuts on medium-large formats (16)
- Angle grinder mounted on cutting guide
- Recommendation: advance the diamond disc at speeds suited to the hardness of the material. Going too fast can damage the grinder, deform the diamond disc, and/or break the slab.

FR / 2.3. DÉCOUPE DES DALLES

La découpe au jet d'eau à l'aide d'équipements professionnels permet une meilleure qualité de coupe. (10,11)

Pour la coupe à sec, choisir l'outil le plus approprié selon le type de coupe et le format de la dalle:

- Coupe-carreaux linéaires pour les formats jusqu'à 60x120 cm. (12)
- Formats de 90x90, 90x270, 120x120 cm → coupe avec lame diamantée, avec guide placé sur une surface rigide et stable, capable d'absorber les vibrations produites par les outils de coupe. (13)
- Placer les dalles sur une surface rigide et stable, capable d'absorber les vibrations produites par les outils de coupe. Fixer le guide de coupe à la dalle. La plupart des guides sont déjà équipés de coupe-carreaux diamantés.
- Réaliser la coupe en exerçant une pression uniforme, avec des mouvements et une force constants sur toute la ligne de coupe. (14,15)
- La rupture doit être réalisée à l'aide de pinces appropriées, agissant simultanément sur les deux extrémités et au centre de la ligne de coupe.
- Utiliser une meuleuse d'angle munie d'un disque diamanté pour les coupes droites des formats de moyens à grands. (16)
- Meuleuse d'angle montée sur le guide de coupe.
- Recommandation: adapter la vitesse de rotation du disque diamanté en fonction de la dureté du matériau. Une vitesse excessive pourrait endommager la meuleuse, déformer le disque diamanté et/ou casser la dalle.

DE / 2.3. PLATTENZUSCHNITT

Das Wasserstrahlschneiden mit professioneller Ausrüstung bietet eine bessere Schnittqualität. (10,11)

Im Falle von Trockenschnitten ist je nach Schnittart und Plattenformat das geeignetste Werkzeug zu wählen:

- Linearschneider für Formate bis 60x120 cm (12)
- Für die Formate 90x90, 90x270, 120x120 cm → Schnitt mit Diamantklinge mit Führung, auf einer steifen und stabilen Ebene positioniert, die eventuell von den Schneidwerkzeugen erzeugte Vibrationen absorbieren kann. (13)
- Die Platte auf eine steife und stabile Ebene setzen, die eventuell von den Schneidern erzeugte Vibrationen absorbieren kann.
- Die Schneidföhrung an der Platte befestigen. Die meisten Föhrungen sind bereits mit Diamantschneidern ausgestattet.
- Beim Schneiden an der ganzen Schneidlinie entlang einen gleichmäÙigen Druck mit gleichbleibenden Bewegungen und konstanter Kraft ausüben. (14,15)
- Die Brechphase muss mit geeigneten Brechzangen erfolgen, die gleichzeitig auf die zwei Enden und auf die Mitte der Schneidlinie wirken.
- Um an mittelgroÙen / groÙen Formaten lineare Schnitte zu fertigen, ist ein Winkelschleifer mit Diamantscheibe zu verwenden. (16)
- Winkelschleifer, auf Schneidföhrung montiert.
- Dringend empfohlen: Die Vorschubgeschwindigkeit der Diamantscheibe ist in Proportion zur Materialhärte zu kalibrieren. Eine zu hohe Geschwindigkeit könnte den Schleifer beschädigen, die Diamantscheibe verformen und/oder die Platte brechen.

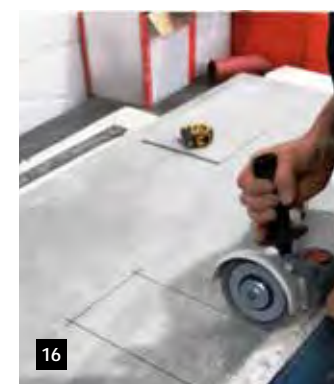
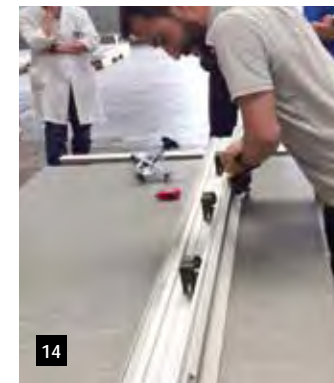
**IT / 3. FORATURA DELLE LASTRE**

Di seguito segnaliamo alcuni accorgimenti che permettono di realizzare sulle lastre in grès porcellanato fori e aperture (quadrate o rettangolari) in modo agevole e superando le situazioni più difficili, operando in sicurezza e con professionalità. In tutti i casi, l'operazione deve essere condotta su una superficie piana, stabile, adagiando la piastrella possibilmente su un foglio di polistirolo o di gomma morbida, per attenuare le vibrazioni e rendere più sicuro il lavoro. A tal fine, si segnala che in commercio esistono idonei banchi che fungono da supporto durante le operazioni di taglio e foratura, che permettono di effettuare tali operazioni garantendo sicurezza per l'operatore e integrità per la lastra.

La soluzione più rapida per praticare fori circolari su piastrelle in grès porcellanato è quella di ricorrere a frese diamantate professionali applicabili ai comuni flessibili per dischi intercambiabili (disponibili in vari diametri da 6 mm a 75 mm), in grado di realizzare un foro in pochi minuti e lasciando la superficie della piastrella integra e priva di scheggiature sul contorno dell'apertura. È importante realizzare il foro facendo oscillare la fresa con movimento rotatorio, senza esercitare eccessiva pressione sul punto d'attacco, avendo l'accortezza di nebulizzare costantemente con acqua il punto esatto ove si vuole realizzare il foro. (17)

La nebulizzazione produce il duplice beneficio di allungare la vita utile della fresa e ridurre l'attrito fresa/ceramica, principale responsabile di eventuali sbecature e micro-cricche che potrebbero formarsi. Prima di incidere con fresa diamantata, è inoltre consigliabile verificarne lo stato di usura del diamante:

frese eccessivamente usurate possono portare a risultati non ottimali. È consigliabile realizzare il foro in più riprese, nebulizzando/bagnando costantemente l'area di incisione. Nel caso di aperture rettangolari o quadrate, la tecnica dell'incisione e taglio con solo disco montato su flessibile (spesso non idoneo al grès porcellanato) risulta oltremodo difficoltosa e dall'esito incerto: lo stress provocato dal taglio e le vibrazioni trasmesse al materiale, in condizioni di lavoro assai precarie come si riscontrano spesso nei cantieri, può provocare fessurazioni e rotture anche dopo l'incollaggio del pezzo. Nella maggior parte dei casi, il tutto è risolvibile procedendo nel seguente modo:

- seguendo la procedura sopra descritta per la realizzazione dei fori ed utilizzando frese diamantate professionali, realizzare 4 fori del diametro di circa 5-7 mm in corrispondenza dei vertici che delimitano l'apertura, con l'utilizzo di un trapano non a percussione
- incidere delicatamente e progressivamente la piastrella da foro a foro con flessibile e disco diamantato professionale idoneo per grès porcellanato.

Di importanza fondamentale in questa delicata fase di taglio è la qualità e la struttura del disco diamantato che, operando a velocità molto elevata, deve mantenere integre le proprie caratteristiche di rigidità e taglio (18, 19)

EN / 3. LINEAR CUTS - POCKET CUT ON WORKTABLE - CIRCULAR HOLES - POCKET CUTS

Support the slab on a flat, stable surface (worktable, polystyrene or soft rubber sheet)

Use professional-quality diamond bits (for use with angle-grinders), 6 to 75 mm diameter.

Rock the cutter bit in a rotating motion, avoiding excessive pressure; apply a constant spray of water. (17)

Complete the cutting in steps, spraying/bathing the area of the hole constantly.

Cut 4 holes of about 5-7 mm diameter, corresponding to the borders of the pocket corners. If necessary, cut more holes along the borders of the pocket opening.

Cut the slab delicately and continuously from one hole to the next, using angle grinder and professional-quality diamond disc for porcelain tiles (18, 19)

FR / 3. COUPES DROITES - DÉCOUPES CARRÉES SUR ÉTABLIS - TROUS CIRCULAIRES - DÉCOUPES CARRÉES

Poser la dalle sur une surface plane et stable (établi, plaque de polystyrène ou de caoutchouc souple).

Utiliser des forets diamantés professionnels (pour une utilisation avec des meuleuses d'angle) de 6 à 75 mm de diamètre.

Faire osciller le foret avec un mouvement rotatif, sans exercer de pression excessive et en assurant un arrosage d'eau constant. (17)

Réaliser le trou par passes successives, en veillant à arroser/mouiller constamment la zone de perçage.

Réaliser 4 trous d'environ 5 à 7 mm de diamètre au niveau des angles de la découpe. Si nécessaire, réaliser d'autres trous le long des bords de la découpe. Couper la dalle en douceur et de façon régulière d'un trou à l'autre avec une meuleuse d'angle et un disque diamanté professionnel adapté au grès cérame. (18, 19)

DE / 3. LINEARSCHNITTE - ECKIGE ÖFFNUNGEN AUF ARBEITSBÄNKEN - RUNDLÖCHER - ECKIGE ÖFFNUNGEN

Die Platte auf eine ebene und stabile Oberfläche setzen (Arbeitsbank, Blatt aus Polystyrol oder Weichgummi). Professionelle Diamantbohrer im Durchmesser von 6 bis 75 mm benutzen (zur Verwendung mit Winkelschleifern). Den Diamantbohrer mit kreisender Bewegung schwenken, ohne einen zu großen Druck auszuüben; dabei ständig mit Wassernebel besprühen. (17)

Die Bohrung in mehreren Schritten fertigen und dabei den Einschnittbereich ständig besprühen/befeuchten. 4 Bohrungen im Durchmesser von ca. 5-7 mm an den Ecken der Öffnung fertigen. Wenn notwendig, weitere Bohrungen an den Rändern der Öffnung entlang fertigen. Die Platte mit dem Winkelschleifer mit für Feinsteinzeug geeigneter professioneller Diamantschleibe vorsichtig und konstant von Bohrung zu Bohrung schneiden. (18, 19)

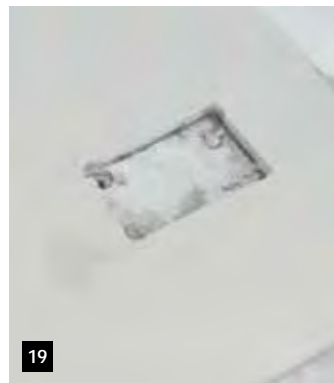

IT / 4. MOVIMENTAZIONE E STOCCAGGIO DELLE LASTRE IMBALLATE

Le lastre in formato 90x90, 45x90, 30x90, 60x120, 120x120cm sono fornite disposte su pallet e protette da opportune sponde laterali / gabbie di protezione, che limitano urti accidentali. In fase di stoccaggio in magazzino, possono essere opportunamente sovrapposte per un massimo di 3 o 4 palette, a seconda del formato. Le lastre in formato 90x270 cm sono fornite in imballi costituiti da casse di legno, che possono essere opportunamente sovrapposte in fase di stoccaggio per un massimo di 5 casse. La movimentazione delle lastre imballate deve sempre avvenire per mezzo di carrelli elevatori di idonea portata. Sia i pallet che le

casse di legno, devono sempre essere movimentati singolarmente e la lunghezza delle forche deve essere commisurata alle dimensioni dell'imballo (ad esempio, forche lunghe 1,5 m, se il materiale viene movimentato dal lato lungo, oppure 2,5 m, se le movimentate dal lato corto). Le stesse forche devono poi essere predisposte in posizione di massima apertura, al fine di migliorare la stabilità dell'imballo durante la movimentazione.

EN / 4. STORAGE AND HANDLING THE PACKS

90x90, 45x90, 30x90, 60x120, 120x120 cm formats → shipped on pallets with side collars/protective cages. Store in stacks up to a maximum of 3 or 4 pallets, depending on format. Slabs in 90x270 cm format are packed in wooden crates. Store in stacks up to a maximum of 5 crates.

Handle using suitable capacity forklift trucks. Move single packs: using fork depth suited to the size of the pack (e.g. 2.5 m for crates). Use maximum fork width when moving → better pack stability.

FR / 4. MANIPULATION ET STOCKAGE DES DALLES EMBALLÉES

Dalles au format 90x90, 45x90, 30x90, 60x120, 120x120 cm → livrées sur palettes et protégées par des bords latéraux/caisses-palettes. Lors du stockage, elles peuvent être empilées sur 3 ou 4 palettes maximum selon le format.

Dalles au format 90x270 cm → emballées dans des caisses en bois qui peuvent être empilées lors du stockage jusqu'à un maximum de 5 caisses.

La manutention doit toujours se faire au moyen de chariots élévateurs de capacité appropriée.

Les emballages doivent toujours être manipulés séparément: la longueur des fourches doit être proportionnelle à la taille de l'emballage (par exemple, fourches de 2,5 m de long pour les caisses).

Utilisation des fourches en position d'ouverture maximale → amélioration de la stabilité de l'emballage.

DE / 4. HANDHABUNG UND LAGERUNG DER VERPACKTEN PLATTEN

Platten in den Formaten 90x90, 45x90, 30x90, 60x120, 120x120 cm → werden auf Paletten ausgeliefert, die mit Seitenwänden / Schutzkäfigen geschützt werden. Bei der Einlagerung können je nach Format maximal 3 oder 4 Paletten übereinandergestellt werden.

Platten in den Formaten 90x270 cm → werden in Holzkisten verpackt, von denen bei der Einlagerung maximal 5 übereinandergestellt werden können.

Die Handhabung muss immer mit Gabelstaplern mit geeigneter Tragfähigkeit erfolgen.

Die Packungen sind immer einzeln zu bewegen: Die Länge der Stapelgabeln muss immer für die Abmessungen der Packung angemessen sein (z.B. 2,5 m lange Gabeln für Kisten).

Die Gabeln in ihrer maximalen Öffnungsposition verwenden → führt zu einer besseren Stabilität der Packung.

IT / 5. MOVIMENTAZIONE DELLE LASTRE NELLE FASI PRECEDENTI LA POSA

Una volta estratto dall'imballo il cartone e, da esso, la lastra, movimentarla con cura prestando particolare attenzione agli angoli per evitare sbeccature o rotture, seguendo i consigli che di

seguito sono meglio esplicitati.

Il numero di operatori addetti alla movimentazione varia in funzione del formato delle lastre stesse. In qualsiasi caso, tutti gli addetti alla movimentazione devono essere sempre muniti di idonei dispositivi di sicurezza e protezione individuali. Per i formati 90x90 occorre un operatore, due operatori per i formati 120x120. Si segnala che esistono opportune mono o bi-ventose, che facilitano il sollevamento, la movimentazione (e dunque la posa nella fase successiva). Prima di applicare le ventose, è consigliabile utilizzare una spugna bagnata od uno straccio inumidito sia sulla superficie della lastra che sulla ventosa stessa, al fine di eliminare polvere o residui che ne diminuiscono sensibilmente il potere adesivo. L'utilizzo di mono o bi-ventose di tipo Vacuum (ossia a vuoto controllato) è normalmente da preferirsi perché, oltre a consentire una maggiore azione di presa sulla superficie (anche strutturata), consentono in continuo di verificarne l'entità per mezzo del manometro installato. Infine, quattro operatori sono normalmente consigliati per la movimentazione di lastre in formato 90x270 cm.

In questo ultimo caso, i quattro operatori possono spostare la lastra mediante opportuni telai / profili modulabili (in base al formato della lastra, vedi immagini sottostanti) dotati di ventose. L'utilizzo di ventose tipo Vacuum (a vuoto controllato) è da preferirsi in luogo alle normali bi-ventose in commercio.

Con una spugna bagnata od uno straccio inumidito, eliminare polvere o residui che possono essere presenti sulla lastra ed inumidire tanto la superficie quanto la gomma delle ventose stesse.

Una volta sollevata la lastra, essa deve essere posizionata in maniera stabile su di un supporto che ne consenta la movimentazione in posizione verticale e la successiva spalmatura del collante.

A tale scopo, si segnala che in commercio esistono diverse tipologie di telai verticali mobili, o carrelli, nei quali è possibile incastrare saldamente i profili di sollevamento sopra menzionati. Durante la fase del trasporto della lastra, evitare il più possibile brusche oscillazioni o vibrazioni del materiale. (20, 21)

EN / 5. HANDLING

Remove boxes from the pack, handling them with care. Be careful of the edges to avoid chips and breakage.

Number of personnel recommended for handling:

- 90x90, cm → one worker
- 120x120, → two workers
- 90x270 → preferably four workers (at least two) using suction cup handling devices

Position the slab in a stable manner on supports, allowing movement into vertical position and subsequent application of adhesive (movable vertical racks). Use of suction cup devices with pressure gauge is recommended → for continuous monitoring of suction grip.

Avoid sudden oscillations and vibration of the material when transporting the slab. (20, 21)

FR / 5. MANUTENTION

Retirer les cartons de l'emballage en les manipulant avec précaution et en faisant particulièrement attention aux coins afin d'éviter toute ébréchure ou rupture.

Nombre d'opérateurs recommandés pour la manutention :

- 90x90 → un opérateur

- 120x120 → deux opérateurs
- 90x270 → de préférence quatre opérateurs (au minimum deux) avec l'utilisation de ventouses pour faciliter la manutention.

Placer la dalle en position stable sur un support permettant de la manutentionner verticalement et d'appliquer ensuite la colle (châssis verticaux mobiles). L'utilisation de ventouses avec manomètre est recommandée → pour un contrôle constant de l'adhérence.

Pendant le transport de la dalle, éviter les oscillations brusques ou les vibrations du matériau. (20, 21)

DE / 5. HANDHABUNG

Die Kartons vorsichtig aus der Packung nehmen und dabei besonders auf die Ecken achten, um Absplitterungen oder Brüche zu vermeiden.

Zahl der zur Handhabung empfohlenen Personen:

- 90x90 → eine Person
- 120x120 → zwei Personen
- 90x270 → empfohlen sind 4 Personen (mindestens zwei) und die Verwendung von Saugnapfen, um die Handhabung zu erleichtern.

Die Platte stabil auf eine Unterlage setzen, auf der sie in die vertikale Position bewegt und daraufhin mit dem Kleber bestrichen werden kann (bewegliche vertikale Rahmen). Es wird zur Verwendung von Saugnapfen mit Manometer empfohlen → für eine konstante Greifkontrolle.

Während des Transports der Platte sind schroffe Schwingungen oder Vibrationen des Materials zu vermeiden. (20, 21)

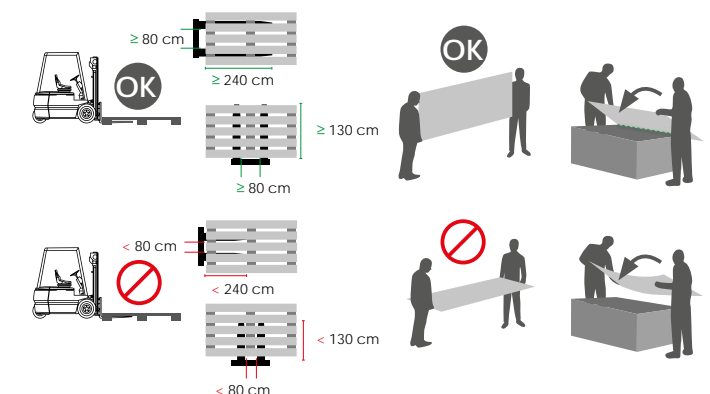

Condizioni generali di vendita

General sales conditions / Conditions générales de vente / Allgemeine Verkaufsbedingungen

IT / 1. PREMESSA

Le presenti condizioni generali, salvo eventuali modificazioni o deroghe concordate per iscritto, disciplinano tutti i contratti di vendita fra noi e l'acquirente. Le variazioni delle condizioni generali di vendita, le transazioni e gli abbuoni, anche se effettuati su iniziativa dei nostri agenti, saranno impegnative per noi solo dopo nostra eventuale conferma scritta e comunque limitate ai contratti a cui si riferiscono.

2. OGGETTO DELLA FORNITURA

La fornitura comprende solamente le prestazioni, i materiali ed i quantitativi specificati nella nostra conferma d'ordine o in altre comunicazioni scritte provenienti da noi. Il testo della nostra conferma d'ordine prevarrà, in ogni caso, sul testo difforme dell'eventuale offerta o della ordinazione.

3. CONFERMA D'ORDINE

Qualora nella nostra conferma d'ordine esistano differenze nei singoli elementi che la compongono rispetto alle intese od alle ordinazioni, il compratore che non abbia contestato con lettera raccomandata spedita entro dieci giorni dalla ricezione della conferma tali differenze, è tenuto ad accettarla così come è stata redatta.

4. CONSEGNA

La merce, anche se venduta "franco arrivo", o franco domicilio del compratore, viaggia a rischio e pericolo di quest'ultimo ed ogni nostra responsabilità cessa con la consegna al vettore, nei confronti del quale il compratore - effettuate le opportune verifiche - dovrà sporgere eventuali reclami. L'onere dello scarico della merce dai mezzi di trasporto grava sul compratore. Le spedizioni, via mare o via terra, concernenti forniture sull'estero, vengono effettuate in base alle condizioni scelte di volta in volta, riportate negli "INCOTERMS" approvati dalla Camera di Commercio Internazionale nel 1953 e nei successivi.

5. TERMINI DI CONSEGNA

Il termine stabilito per la consegna della merce deve intendersi a favore di entrambi i contraenti. Salvo l'inserimento di particolari clausole, esso deve di norma considerarsi puramente indicativo e non essenziale. Quando siano intervenute modificazioni al contratto, il termine resta prorogato per un periodo uguale a quello inizialmente stabilito.

Ogni evento di forza maggiore sospende la decorrenza del termine per tutta la sua durata. Il ritardo nella consegna della merce, dovuto a cause documentate, anche se non espressamente previste, non dà alcun diritto al compratore di chiedere la risoluzione del contratto, indennizzi o risarcimenti.

6. PAGAMENTI

Il luogo di pagamento è fissato presso la nostra Sede anche nel caso di emissioni di tratte o ricevute bancarie, ovvero di rilascio di effetti cambiari. Il ritardo, anche parziale, del pagamento delle nostre fatture oltre la pattuita scadenza, darà luogo all'immediata decorrenza degli interessi di mora nella misura dei tassi passivi praticati dagli istituti bancari. Inoltre il mancato o ritardato pagamento delle fatture

- per qualsivoglia ragione - ci darà diritto, impreviata ogni

altra iniziativa, di pretendere il pagamento anticipato delle restanti forniture, oppure di ritenere temporaneamente sospeso o definitivamente risolto il contratto e di annullare l'evasione di eventuali altri ordini in corso, senza che il compratore possa avanzare pretese di compensi, indennizzi od altro. Nessuna eccezione, salvo quella di nullità, annullabilità e rescissione del contratto, può essere opposta dall'acquirente, al fine di ritardare od evitare il pagamento.

7. RISERVA DI PROPRIETÀ

Nel caso in cui il pagamento, per accordi contrattuali, debba essere effettuato - in tutto o in parte - dopo la consegna, i prodotti consegnati restano di nostra proprietà fino all'integrale pagamento del prezzo.

8. GARANZIA

La nostra garanzia è limitata ai materiali di 1a scelta, con la tolleranza del 5% (cinqueper cento) circa. Qualsiasi garanzia per vizi rimane quindi espressamente esclusa per i materiali di 2a e di 3a scelta o di stock che, come le partite occasionali, si intendono sempre vendute come "viste" e "piaciute". Le differenze di tonalità non possono essere denunciate come vizio di materiale. Eventuali reclami e contestazioni dovranno essere notificati, a pena di decadenza, a mezzo lettera raccomandata, unicamente presso la nostra Sede, prima della posa in opera del materiale e comunque nei termini di legge. La posa in opera del materiale determina la decadenza dall'azione per vizi tanto palesi che occulti, importando rinuncia implicita alla garanzia di cui all'art. 1490 c.c. In ogni caso la nostra garanzia comprende unicamente la sostituzione del materiale riscontrato difettoso con esclusione di ogni ulteriore e diversa obbligazione. Non ci assumiamo nessuna responsabilità sull'idoneità del materiale all'uso cui il compratore lo intende destinare e ciò neppure nell'ipotesi che, da parte nostra, vengano forniti suggerimenti o indicazioni circa l'installazione e l'impiego dello stesso.

9. MARCHI COMMERCIALI

Il distributore deve utilizzare i nomi ed i marchi commerciali, i logos, ed i domini di cui è titolare esclusiva e fa uso la nuova Riwal Ceramiche S.r.l. al solo fine di pubblicizzare e vendere i prodotti contrattuali. Tanto il nome Riwal Ceramiche quanto ogni altro nome o marchio commerciale, logos e dominio adottati da Riwal Ceramiche S.r.l. non dovranno comparire nella ditta, nella ragione sociale o denominazione sociale o nell'oggetto sociale del distributore anche in combinazione di parole. Il distributore non depositerà o farà depositare nè userà in alcun modo marchi, nomi, o altri segni distintivi che assomiglino graficamente, foneticamente o in qualsiasi altro modo ai marchi e nomi commerciali che fanno capo alla nuova Riwal Ceramiche S.r.l. e si asterrà da qualsiasi comportamento che possa comunque arrecare pregiudizio alla nuova Riwal Ceramiche S.r.l.

10. FORO COMPETENTE

Per qualsiasi controversia, comunque relativa alla fornitura, tanto da parte del venditore come da parte del compratore, viene attribuita competenza, con applicazione della legge italiana, al tribunale di Modena.

11. CLAUSOLA ARBITRALE

Per le forniture all'estero, tutte le controversie eventualmente derivanti dal contratto, saranno risolte in via definitiva secondo il regolamento di conciliazione e di arbitrato della Camera di Commercio Internazionale da uno o più arbitri, in conformità a detto regolamento. Ferme le condizioni generali che precedono, il diritto sostanziale applicabile sarà quello esclusivamente italiano.

EN / 1. PREMISE

These general conditions, unless modified or extended and then expressly agreed upon in writing, shall govern all the sales agreements between Gruppo RI.WAL Ceramiche and the purchasers. All transactions, variations to the general sales conditions, as well as discounts, even if such offers are made by our agents, shall be binding for RI.WAL only after its written confirmation and, in any case, shall be limited by the agreements they refer to.

2. SUPPLY

The supply includes the services, the materials and the quantities stipulated in our order acknowledgement or in other means of written communication provided by RI.WAL. However, the text of our order confirmation will supersede any different text contained in the previous offer or order.

3. ORDER CONFIRMATION

If there are any differences between the elements in the order confirmation and those in the order or those agreed beforehand and the purchaser does not object to them within 10 days by means of a recorded delivery letter, this latter shall be obliged to accept the order confirmation as it stands.

4. DELIVERY

The goods, even if sold "free at destination" i.e. with carriage to the purchaser paid, shall travel at this latter's risk and all our responsibilities towards the purchaser cease when the goods are handed over to the carrier, to whom the purchaser, after carrying out the necessary checks, should make any claims. It is the purchaser's duty to unload the goods from the means of transport. Any deliveries made, either by sea or by land, to purchasers abroad are made under the conditions chosen on each occasion, indicated by the 'Incoterms' and subsequent amendments as approved by the International Chamber of Commerce in 1953.

5. DELIVERY TERMS

The terms established for the delivery of the goods must be considered beneficial to both parties. Unless extra clauses are provided for, it is standard to consider the terms as simply indicative and not binding. When the agreement is modified, the term is extended by the same amount of time as originally set. In any events of circumstances beyond our control, the delivery term will be suspended for the entire duration of such events. Delays in delivery whose causes can be proved by documentation, even though not expressly provided for, do not result in the purchaser's right to terminate the contract, or to apply for indemnities or damages.

6. PAYMENTS

The place of payment is fixed as our head office, even if bank drafts or receipts or bills of exchange are issued. Delays, even partial, in the payment of our invoices (as per the expiry terms agreed upon) shall result in the immediate application of arrears interest, which shall be calculated according to the current bank overdraft rates. Furthermore, failure to pay or delays in payment

of the invoices - for any reason - shall give us the right, with no prejudice to further actions, to claim advanced payment for the rest of the supply, or to consider the agreement suspended temporarily or terminated definitively and to annul all orders being processed at that time, without the purchaser being entitled to compensation, indemnities or suchlike. No exceptions, except the rights to nullity and to terminate and withdraw from the agreement, can be opposed by the purchaser in order to delay or avoid payment.

7. PROPERTY CONDITIONS

If, through contractual agreements, the payment must be made, either in part or in full, after delivery, the products delivered, remain our property until the payment has been made in full.

8. GUARANTEE

Our guarantee is limited to the 1st choice materials, with a tolerance of approximately 5% (five percent). Any guarantee for defects is therefore expressly excluded for 2nd and 3rd choice materials or discounted stock which, as occasionally happens, are always sold as 'seen and approved'. Tonal differences cannot be disputed as material defects. Any claims or complaints must be made in writing, at the risk of forfeiture, and they must be sent via recorded delivery mail to our head offices only. This must be done before the material is laid, within the terms set by law. The laying of the material represents the forfeiture of the right to claim for defects, both clearly visible ones and hidden ones, resulting in the implicit waiving of the guarantee as per article 1490 of the Italian Civil Code. In any case, our guarantee only extends to the replacement of the materials found to be faulty, with the exclusion of any further or different obligation. We cannot accept any responsibility regarding the suitability of the material for the use to which the purchaser puts it, not even if we supply the material with indications or suggestions concerning the installation and use of the material itself.

9. COMPETENT AUTHORITY

For any disputes, relating to the supply, either from the seller or the buyer, shall be dealt with by the court of Modena and the case shall be governed by the Italian law.

10. ARBITRATION CLAUSE

For foreign supplies, any disputes which may arise from the agreement shall be resolved definitively according to the regulations of conciliation and arbitration of the International Chamber of Commerce, by one or more arbitrators, in compliance with the said regulations. The aforementioned general conditions accepted, the Italian law shall govern this agreement.

11.COMMERCIAL TRADEMARKS

The distributor must only use the names, the commercial trademarks, the logos, and the dominion of nuova Riwal S.r.l Ceramiche, who has the exclusive rights with regards to the their use, for the publicising and sale of its contractual products. Both the name Riwal Ceramiche as well as every other name, commercial trademark, logo, dominion or mixture of these words adopted by nuova Riwal Ceramiche S.r.l. must not appear in the company style, the corporate or in the social name or in the company aim of the distributor. The distributor will not use, deposit or allow the filing of the trademarks, names, or other distinctive signs that resemble graphically, phonetically or in any other way the trademarks and commercial names which are owned by Riwal Ceramiche S.r.l. and he will forgo any behaviour that may cause harm to Riwal Ceramiche S.r.l.

FR / 1. AVANT-PROPOS

Les présentes conditions générales de vente disciplinent tous les contrats de vente entre l'acheteur et nous, sauf éventuelles modifications ou dérogations fixées par écrit. Les changements de ces conditions de vente, les transactions et les rabais, même s'ils sont effectués par initiative de nos agents, ne nous engagent qu'après une confirmation écrite de notre part et sont en tout cas limités aux contrats auxquels ils se réfèrent.

2. OBJET DE LA FOURNITURE

La fourniture comprend uniquement les services, les matériaux et les quantités qui sont spécifiés dans notre confirmation de commande ou dans d'autres communications écrites venant de nous. Le texte de notre confirmation de commande prévaudra, de toute façon, sur le texte éventuellement différent de l'offre ou de la commande.

3. CONFIRMATION DE COMMANDE

Si dans notre confirmation de commande il existe des différences dans les parties qui la composent par rapport aux accords ou aux commandes, l'acheteur qui n'a pas contesté ces différences par lettre recommandée dans les dix jours à compter de la date de réception de la confirmation est tenu à l'accepter telle qu'elle a été écrite.

4. LIVRAISON

La marchandise voyage aux risques et périls de l'acheteur, même si elle est vendue "franco arrivée" ou "franco domicile de l'acheteur" et notre responsabilité cesse à partir du moment où nous remettons la marchandise au transporteur. C'est à ce dernier que l'acheteur devra faire d'éventuelles réclamations après avoir effectué les vérifications appropriées. Les frais de déchargement de la marchandise des moyens de transport sont à la charge de l'acheteur. Les expéditions par mer ou par terre des fournitures vers l'étranger sont effectuées sur la base des conditions choisies à chaque fois parmi celles indiquées dans les "INCOTERMS" approuvées par la Chambre de Commerce Internationale en 1963 et dans les suivantes.

5. DÉLAIS DE LIVRAISON

Le délai établi pour la livraison de la marchandise doit s'entendre en faveur des deux contractants. A part l'introduction de clauses particulières, il doit être considéré normalement comme purement indicatif et non essentiel. Si le contrat a subi des modifications, le délai est prorogé d'une période égale à celle établie initialement. Tout événement de force majeure suspend le point de départ du délai pour toute sa durée. Tout retard dans la livraison de la marchandise dû à des causes documentées, même si elles n'ont pas été expressément prévues, ne donne aucun droit à l'acheteur de demander la résiliation du contrat, des indemnisations ou des dédommagements.

6. PAIEMENTS

Le lieu de paiement est le siège de notre société, même en cas d'émission de traites ou de récépissés sur banque, c'est-à-dire de remise de lettres de change. Le retard, même partiel, du paiement de nos factures par rapport au délai convenu, donnera lieu à l'immédiat démarrage du calcul des intérêts moratoires dans la mesure des taux passifs pratiqués par les établissements bancaires. En outre, le non-paiement ou le retard dans le paiement des factures - quelle qu'en soit la raison - nous donnera le droit, toute autre initiative étant en suspens, de prétendre le paiement anticipé des autres fournitures, ou bien de considérer temporairement suspendu ou définitivement résilié le contrat et d'annuler l'expédition des autres commandes éventuellement en cours, sans que l'acheteur puisse avancer des prétentions de dédommagements, d'indemnisations ou autres. Aucune

exception, sauf celle de nullité, d'annulation et de résiliation du contrat, ne peut être opposée par l'acheteur pour retarder ou éviter le paiement.

7. RÉSERVE DE PROPRIÉTÉ

Si, suite à des accords contractuels, le paiement doit être effectué - totalement ou partiellement - après la livraison, nous restons propriétaires des produits livrés jusqu'au paiement intégral du prix.

8. GARANTIE

Notre garantie est limitée aux matériaux de 1er choix, avec une tolérance de 5% (cinq pour cent) environ. Toute garantie pour des défauts reste donc expressément exclue pour des matériaux de 2e et de 3e choix ou pour des stocks qui, comme les lots occasionnels, s'entendent toujours vendus tels quels. Les différences de nuances ne peuvent être considérées comme défauts du matériau. Les réclamations et contestations éventuelles doivent être notifiées, sous peine de déchéance, par lettre recommandée, envoyée à l'adresse de notre société, avant que le matériau ne soit posé et en tout cas dans les termes de la loi. La pose du matériau implique la déchéance de l'action pour défauts, aussi bien visibles que cachés, et comporte le renoncement implicite à la garantie visée par l'art. 1490 du code civil italien. Quoi qu'il en soit, notre garantie ne comprend que le remplacement du matériau défectueux et n'inclut aucune autre obligation. Nous déclinons toute responsabilité sur l'adaptabilité du matériau à l'usage que l'acheteur veut en faire, même dans le cas où nous aurions nous-mêmes donné des conseils ou des indications sur l'installation et l'emploi du matériau.

9. TRIBUNAL COMPÉTENT

Pour tout différend relatif à la fourniture, aussi bien de la part du vendeur que de la part de l'acheteur, c'est au tribunal de Modène qu'est attribuée la compétence en conformité avec la loi italienne.

10. CLAUSES D'ARBITRAGE

Pour les fournitures à l'étranger, tous les différends dérivant éventuellement du contrat seront résolus d'une manière définitive suivant le règlement de conciliation et d'arbitrage de la Chambre de Commerce Internationale par un ou plusieurs arbitres, en conformité avec ledit règlement. Les conditions générales qui précèdent restant entendues, le droit substantiel applicable sera exclusivement le droit italien.

11. MARQUES COMMERCIALES

Le distributeur doit utiliser les noms et les marques commerciales, les logos et les domaines dont la société nuova Riwal Ceramiche S.r.l. est propriétaire et qu'elle emploie, uniquement dans le but de publiciser et de vendre les produits contractuels. Le nom de Riwal Ceramiche ainsi que tout autre nom ou marque commerciale, logos et domaine adoptés par Riwal Ceramiche S.r.l. ne devront comparaitre dans le nom de la firme, la raison sociale, la dénomination sociale ou dans l'objet social du distributeur, même dans une combinaison de mots.

Le distributeur ne pourra déposer, faire déposer ou utiliser de quelque manière que ce soit des marques, noms ou autres signes distinctifs qui ressemblent graphiquement, phonétiquement ou de toute autre façon aux marques et noms commerciaux appartenant à Riwal Ceramiche S.r.l.. Il s'abstiendra en outre de tout comportement pouvant porter préjudice de quelque façon que ce soit à Riwal Ceramiche S.r.l.

DE / 1. VORBEMERKUNG

Die vorliegenden Allgemeinen Bedingungen regeln vorbehaltlich schriftlich vereinbarter Änderungen oder Abweichungen alle Verkaufsverträge zwischen uns und dem Käufer. Die Änderungen der Allgemeinen Verkaufsbedingungen, die Transaktionen und die Gutschriften sind - auch falls sie auf Veranlassung unserer Handelsvertreter vorgenommen werden - nur dann für uns verbindlich, falls sie von uns schriftlich bestätigt worden sind, und sind in jedem Fall ausschließlich auf die Verträge beschränkt, auf die sie sich beziehen.

2. GEGENSTAND DER LIEFERUNG

Die Lieferung umfasst nur die auf unserer Auftragsbestätigung oder sonstigen schriftlichen Mitteilungen von uns aufgeführten Leistungen, Materialien und Mengen. Der Text unserer Auftragsbestätigung hat in jedem Fall Vorrang vor dem gegebenenfalls abweichenden Text des Auftrags oder der Bestellung.

3. AUFTRAGSBESTÄTIGUNG

Falls unsere Auftragsbestätigung bei einzelnen Positionen, aus denen sie sich zusammensetzt, Abweichungen von den Vereinbarungen oder den Bestellungen aufweist, so ist der Käufer, der diese nicht innerhalb von zehn Tagen per Einschreiben bestandet, gehalten, diese so, wie sie aufgesetzt worden sind, zu akzeptieren.

4. LIEFERUNG

Die Ware reist auf Risiko und Gefahr des Käufers, auch falls sie "frei Bestimmung" oder "frei Haus des Käufers" verkauft wird und unsere Haftung endet mit der Auslieferung an den Transportunternehmer, bei dem der Käufer - nach Durchführung der entsprechenden Überprüfungen - eventuelle Beanstandungen geltend machen muss. Das Abladen der Ware von den Transportfahrzeugen geht zu Lasten des Käufers. Die Lieferungen ins Ausland auf dem See- oder Landweg werden auf Grundlage von von Mal zu Mal ausgewählten Bedingungen ausgeführt, die in den von der Internationalen Handelskammer 1953ff. anerkannten "INCOTERMS" angegeben werden.

5. LIEFERFRISTEN

Die Frist, die für die Lieferung der Ware vereinbart wird, ist zu Gunsten beider Vertragspartner auszulegen. Vorbehaltlich der Aufnahme besonderer Klauseln ist sie als unverbindlich und nicht wesentlich anzusehen. Bei Änderungen des Vertrages wird die Frist um einen Zeitraum verlängert, der dem ursprünglich vereinbarten entspricht. Bei Fällen von höherer Gewalt wird die Frist für deren gesamte Dauer ausgesetzt. Diese verspätete Lieferung der Ware, die auf dokumentierten, auch nicht ausdrücklich vorgesehenen Ursachen beruht, berechtigt den Käufer nicht zur Auflösung des Vertrages oder zu Entschädigungsforderungen.

6. BEZAHLUNG

Der Ort der Bezahlung wird auf unseren Firmensitz festgelegt, auch im Falle der Ausstellung von Tratten, Bankquittungen oder Wechseln. Bei - auch partieller - Verspätung der Bezahlung unserer Rechnungen über die vereinbarte Fälligkeit hinaus werden mit unmittelbarer Wirkung Säumniszinsen in Höhe des von den Bankinstituten angewendeten Passivzinssatzes fällig. Außerdem berechtigt uns die unterlassene oder verspätete Bezahlung der Rechnungen - aus jedem beliebigem Grund - und unbeachtet aller weiteren Schritte, die Vorauszahlung der verbleibenden Lieferungen zu fordern oder den Vertrag für vorübergehend oder endgültig ausgesetzt zu betrachten und die Auslieferung eventueller sonstiger laufender Bestellungen zu annullieren, ohne dass in diesem Fall Schadensforderungen oder sonstige

Forderungen geltend gemacht werden können. Vorbehaltlich der Nichtigkeit, der Annullierbarkeit und des Rücktritts vom Vertrag können vom Käufer keiner Ausnahmen für die Verspätung oder Unterlassung der Bezahlung vorgebracht werden.

7. EIGENTUMSVORBEHALT

Falls die Bezahlung den vertraglichen Vereinbarungen gemäß - ganz oder teilweise - nach der Lieferung zu erfolgen hat, so bleiben die gelieferten Produkte unser Eigentum bis zur vollständigen Bezahlung des Preises.

8. GARANTIE

Unsere Garantie ist auf die Materialien 1. Wahl beschränkt, mit einer Toleranz von ca. 5% (fünf Prozent). Bei Materialien 2. und 3. Wahl sowie bei Lagerbeständen, die wie gelegentliche Partien stets als "gesehen" und gefallen" verkauft werden, ist jede Garantieleistung für Mängel ausgeschlossen. Tonabweichungen können nicht als Mängel geltend gemacht werden. Eventuelle Reklamationen und Beanstandungen müssen vor der Verlegung des Materials und vor Ablauf der gesetzlichen Frist per Einschreiben einzig und allein an unseren Firmensitz gemeldet werden, anderenfalls verfällt der Gewährleistungsanspruch. Die Verlegung des Materials führt zum Verfall des Gewährleistungsanspruches für offensichtliche und versteckte Mängel und führt gemäß § 1490 des ital. Bürgerlichen Gesetzbuches zu einem impliziten Verzicht auf den Garantieleistungsanspruch. In jedem Fall umfasst unsere Garantie ausschließlich die Ersetzung des mangelhaften Materials und alle weiteren Verpflichtungen sind ausgeschlossen. Wir übernehmen keinerlei Haftung für Eignung des Materials für die vom Käufer vorgesehene Verwendungsweise, auch dann nicht, wenn unsererseits Empfehlungen oder Angaben zur Verwendung desselben gemacht werden.

9. GERICHTSSTAND

Sämtliche Rechtssachen zwischen dem Verkäufer und dem Käufer, die sich auf die Lieferung beziehen, unterliegen der italienischen Rechtsprechung; Gerichtsstand ist Modena.

10. SCHIEDSKLAUSEL

Bei Lieferungen ins Ausland werden sämtliche Rechtssachen, die aus dem Vertrag entstehen, in definitiver Weise auf Grundlage der Schlichtungsbestimmungen der Internationalen Handelskammer von einem oder mehreren Schlichtern entschieden. Unter Beibehaltung der vorausgehenden Allgemeinen Bedingungen ist im wesentlichen das italienische Recht anwendbar.

11. HANDELSMARKEN

Der Händler darf die Namen, Handelsmarken, Logos sowie Domänen, deren ausschließlicher Inhaber und Benutzer nuova Riwal Ceramiche S.r.l. ist, ausschließlich für die Werbung sowie für den Verkauf der Vertragsprodukte verwenden. Sowohl der Name nuova Riwal Ceramiche, als auch alle anderen von nuova Riwal Ceramiche S.r.l. verwendeten Namen, Handelsmarken, Logos und Domänen dürfen nicht im Namen, der Geschäftsbezeichnung oder im Geschäftszweck des Händlers erscheinen, auch nicht in Wortkombinationen. Der Händler hinterlegt keine Marken, Namen oder sonstige Zeichnungen, die den Handelsnamen und -marken von nuova Riwal Ceramiche S.r.l. auf grafische, phonetische oder sonstige Weise ähnlich sind und er vermeldet sämtliche Verhaltensweisen, die nuova Riwal Ceramiche S.r.l. schädigen könnten.

COLLECTIONS BOOK 24

AD: Marketing Dept.

04/2024

© Alfalux - Nuova Riwal Ceramiche srl

La ditta si riserva il diritto di apportare in ogni momento modifiche tecniche ed estetiche.

La stampa tipografica non sempre permette la fedele riproduzione dei colori e delle tinte rispetto agli originali.

The company reserves the right to change, at any time and without prior warning, the technical specifications and dimension of the articles. The printing process doesn't always permit a faithful reproduction of colours and tones as compared to the original.



SEDE LEGALE: Via Giardini, 24
41042 Fiorano Modenese (MO)
SEDE AMMINISTRATIVA: Via Statale 467,109
42013 Casalgrande (RE)



Via della Repubblica, 16
42014 Roteglia di Castellarano
Reggio Emilia - Italy
Tel. +39 0536 869211
Fax +39 0536 851502
Fax +39 0536 832643
www.alfaceramiche.com
export.alfa@riwal.it
italia.alfa@riwal.it